



Cata+List 2019
Design & Architectural collections

running from 1st September 2019

Index

<i>pag.</i>			
14	Bic B02	50	Nelly
18	Bic B07	52	Nemo
19	Bic B12	55	Pop Bijou
20	Bic B16	72	Pop Bon Bon
21	Bic B25-B50-B60	219	Pop Brooklyn
196	Binari 230V	59	Pop C'est Moi
197	Binari 48V	63	Pop C'est Toi
24	Box	69	Pop Chapeau
22	Brick	66	Pop Chérie
27	Club C1 bi - color	205	Pop Host bi-color Ø32,0
26	Club C1 mono - color	206	Pop Host bi-color Ø80,0
28	Club C2 mono - color	211	Pop Host L/M - T/N
29	Club C3 mono - color	201	Pop Host mono-color Ø32,0
80	Easy Pop P00 Ø3,0	202	Pop Host mono-color Ø80,0
81	Easy Pop P00 NaNo Ø3,0	208	Pop Host W Ø32,0 - Ø80,0
93	Easy Pop P01 Bulb	217	Pop P120 - P200
83	Easy Pop P01 Ø4,0	78	Pop P00 Ø3,0
88	Easy Pop P01 Ø5,5	79	Pop P00 NaNo Ø3,0
90	Easy Pop P01 NaNo Ø5,5	82	Pop P01 Ø4,0
99	Easy Pop P02 Ø5,5	92	Pop P01 Bulb
106	Easy Pop P03 Ø8,0	84	Pop P01 Ø5,5
108	Easy Pop P03 NaNo Ø8,0	86	Pop P01 NaNo Ø5,5
139	Easy Pop P04 Ø8,0	97	Pop P01 Dynamic Ø12,5
114	Easy Pop PX3 Ø10,0	94	Pop P01 Static Ø12,5
116	Easy Pop PX3 NaNo Ø10,0	98	Pop P02 Ø5,5
120	Easy Pop PY3 Ø10,0	100	Pop P03 Ø6,0
121	Easy Pop PY3 NaNo Ø10,0	101	Pop P03 NaNo Ø6,0
124	Easy Pop PY3 Ø10,0 Glass	102	Pop P03 Ø8,0
125	Easy Pop PY3 NaNo Ø10,0 Glass	104	Pop P03 NaNo Ø8,0
129	Easy Pop PZ3 Ø10,0	130	Pop P03 Ø17,0
31	e-Pad	135	Pop P03 Look Ø17,0
32	J&B	132	Pop P03 Static Ø17,0
34	J&J	133	Pop P03 Wall Wash Ø17,0
36	Jo Fly	137	Pop P04 Ø8,0
39	Jumbo	140	Pop P04 Ø12,0
23	micro - Box	142	Pop P04 Magic Ø3,0
45	MoMa bi-color Ø40,0 - Ø60,0	145	Pop P04K Magic Ø3,0
49	MoMa L/M	146	Pop P05 Ø6,7 - Ø8,2 brickwork
43	MoMa mono-color Ø40,0 - Ø60,0	148	Pop P05 Ø6,7 - Ø8,2 plasterboard
47	MoMa W Ø40,0 - Ø60,0	156	Pop P06 mono-color Ø6,0 - Ø12,0
		158	Pop P06 bi-color Ø6,0
		159	Pop P06 bi-color Ø12,0
		162	Pop P07 bi-color Ø6,0
		163	Pop P07 bi-color Ø12,0
		164	Pop P07 Bulb
		170	Pop P07 Dynamic Ø12,5
		160	Pop P07 mono-color Ø6,0 - Ø12,0
		171	Pop P07 Pull Ø12,5
		172	Pop P10
		173	Pop P11
		174	Pop P12 Ø3,0
		176	Pop P12 L Ø3,0
		175	Pop P12 T Ø3,0
		117	Pop P12 K Ø3,0
		178	Pop P12 Ø7,0
		179	Pop P12 Ø12,5
		181	Pop P12 Cup Ø3,0
		183	Pop P12 Cup Ø6,0
		185	Pop P12 Cup Ø12,0
		180	Pop P12 Ring Ø3,0
		182	Pop P12 Ring Ø6,0
		184	Pop P12 Ring Ø12,0
		150	Pop Ring Static Ø7,0
		151	Pop Ring Static Ø13,1
		152-153	Pop Ring Dynamic Ø13,1
		154	Pop Ring Pull Ø12,5
		223	Pop Up 1
		224	Pop Up 207
		188	Pop P13 Ø7,0
		189	Pop P13 Ø12,5
		190	Pop P14 Ø3,0
		190	Pop P14 Ø7,0
		191	Pop P14 Ø12,5
		192	Pop P15 Ø3,0
		192	Pop P15 Ø7,0
		193	Pop P15 Ø12,5
		194	Pop P16 Pull
		199	Pop P30 Sun Pull
		198	Pop P30 Sun Static
		213	Pop P40 Chandelier
		214	Pop P50 Pinocchio
		215	Pop P55 Pinocchio
		75	Pop Petit
		186	Pop Polifemo PF1 - PF2
		168	Pop PW7
		110	Pop PX3 Ø10,0
		112	Pop PX3 NaNo Ø10,0
		167	Pop PX7 Ø11,2
		118	Pop PY3 Ø10,0
		119	Pop PY3 NaNo Ø10,0
		122	Pop PY3 Ø10,0 Glass
		123	Pop PY3 NaNo Ø10,0 Glass
		127	Pop PZ3 Ø10,0
		226	Tim T01
		228	Tim T02
		229	Tim T03
		227	Tim T13
		230	Tim T22
		231	Tim T32
		233	Tim T25 - T60 - T120
		235	Tim T124 - T196
		237	Wally W01D Dynamic Ø12,5
		238	Wally Ring WR1D Dynamic Ø13,1
		239	Wally Ring WR1P Pull Ø12,5
		240	Wally W07 Pull Ø12,5
		241	Wally W16 Pull Ø12,5
		243	X - Running
		244	Zip 60-90
		248-251	<i>Filo System (diagrams)</i>
		252-259	<i>Housings index</i>
		267	<i>Installation instructions Bic housings</i>
		268-269	<i>Installation instructions Easy collection</i>
		260-266	<i>Installation instructions Pop housings</i>

Recessed

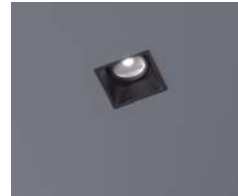

Bic B02 5x5 p.14

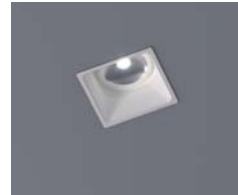

Bic B02 8x8 p.16



Bic B07 7x7 p.18



Bic B12 12x12 p.19



Bic B16 16x16 p.20

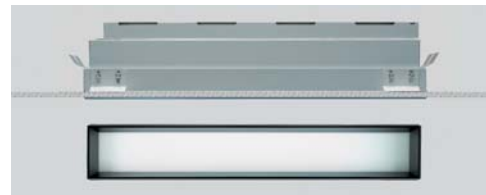

Bic B25 - B50 - B60 p.21



Pop P00 Ø3,0 p.78



Pop P00 NaNo Ø3,0 p.79



Easy Pop P00 Ø3,0 p.80



Easy Pop P00 NaNo Ø3,0 p.81



Pop P01 Ø4,0 p.82



Easy Pop P01 Ø4,0 p.83



Pop P01 Ø5,5 p.84



Pop P01 NaNo Ø5,5 p.86



Easy Pop P01 Ø5,5 p.88



Easy Pop P01 NaNo Ø5,5 p.90



Pop P01 Bulb p.92



Easy Pop P01 Bulb p.93



Pop P01 Static Ø12,5 p.94



Pop P01 Dynamic Ø12,5 p.97



Pop P02 Ø5,5 p.98



Easy Pop P02 Ø5,5 p.99



Pop P03 Ø6,0 p.100



Pop P03 NaNo Ø6,0 p.101



Pop P03 Ø8,0 p.102



Pop P03 NaNo Ø8,0 p.104



Easy Pop P03 Ø8,0 p.106



Easy Pop P03 NaNo Ø8,0 p.108



Pop PX3 Ø10,0 p.110



Pop PX3 NaNo Ø10,0 p.112



Easy Pop PX3 Ø10,0 p.114



Easy Pop PX3 NaNo Ø10,0 p.116



Pop PY3 Ø10,0 p.118



Easy Pop PY3 Ø10,0 p.120



Pop PY3 Ø10,0 Glass p.122



Easy Pop PY3 Ø10,0 Glass p.124

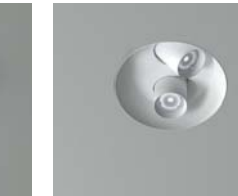

Pop PZ3 Ø10,0 p.127



Easy Pop PZ3 Ø10,0 p.129



Pop P03 Ø17,0 p.130



Pop P03 Static Ø17,0 p.132

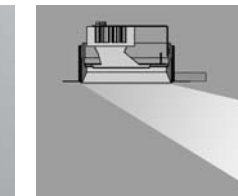

Pop P03 Wall Wash Ø17,0 p.133



Pop P03 Look Ø17,0 p.135



Pop P04 Ø8,0 p.137



Easy Pop P04 Ø8,0 p.139



Pop P04 Ø12,0 p.140



Pop P04 Magic Ø12,0 p.142



Pop P05 p.146



Pop Ring Static Ø7,0 p.150



Pop Ring Static Ø13,1 p.151



Pop Ring Dynamic Ø13,1 p.152



Pop Ring Dynamic Ø13,1 p.153



Pop Ring Pull Ø12,5 p.154

Recessed



Pop P10 p.172



Pop P11 p.173



Pop P12 Ø3,0 p.174



Pop P12 T Ø3,0 p.175



Pop P12L Ø3,0 p.176



Pop P12 Ø7,0 p.178



Pop P12 Ø12,5 p.179



Pop P12 Ring Ø3,0 p.180

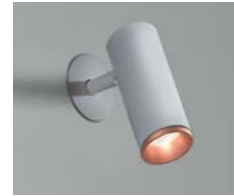

Pop P12 Ring Ø6,0 p.182



Pop P12 Ring Ø12,0 p.184



Wally Dynamic Ø12,5 p.237



Wally Ring Dynamic Ø13,1 p.238



Wally Ring Pull Ø12,5 p.239



Zip 60 - 90 p.244



Housings index p.252



Installation housings Pop p.260

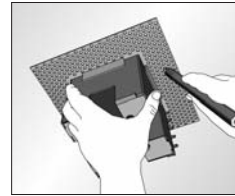

Installation housings Bic p.267



Installation Easy products p.268

Ceiling



MoMa W p.47



Pop P04K p.145



Pop P12K p.117



Pop P07 Ø7,0 - Ø12,0 p.160



Pop P07 bi-color Ø6,0 p.162



Pop P07 bi-color Ø12,0 p.163



Pop P07 Bulb p.164



Pop PX7 Ø11,2 p.167



Pop PW7 p.168



Pop P07D Dynamic Ø12,5 p.170



Pop P07P Pull Ø12,5 p.171



Pop P12 Cup Ø3,0 p.181



Pop P12 Cup Ø6,0 p.183



Pop P12 Cup Ø12,0 p.185



Pop P13 Ø7,0 - Ø12,5 p.188



Pop P30 Sun Static p.198



Pop P30 Sun Pull p.199



Pop Host Ø32,0 - Ø80,0 p.208



Tim T01 p.226



Tim T13 p.227



Tim T02 p.228



Tim T03 p.229



Tim T22 p.230



Tim T32 p.231



Wally W07P Pull p.240



Tim T25 - T60 - T120 p.233

Wall



Bric p.22



Micro Box 7/1 p.23



Micro Box 7/2 p.23



Box p.24



e-Pad Led p.31



MoMa W p.47



MoMa L/M p.49



Nelly p.50



Nemo p.52



Pop P07 Bulb p.164



Pop P12 Cup Ø 3,0 p.181



Pop P12 Cup Ø 6,0 p.183



Pop P12 Cup Ø 12,0 p.185



Pop P13 Ø 7,0 p.188



Pop P13 Ø 12,5 p.189



Pop Host W p.208



Pop Host L/M/ - T/N p.211



Pop Up1 p.223

Projectors for track



Pop P14 Ø 3,0 p.190



Pop P15 Ø 3,0 p.192



Pop P14 Ø 7,0 p.190



Pop P15 Ø 7,0 p.192



Pop P14 Ø 12,5 p.191



Pop P15 Ø 12,5 p.193



Pop P16 Pull p.194



Wally W16 Pull p.241

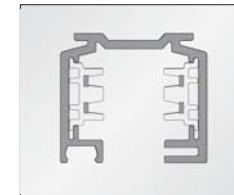

Track 230V 3-CCT p.196

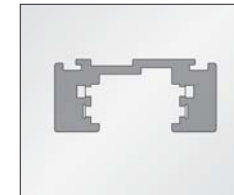

Led Track 48V p.197

Floor lamps



Pop Polifemo p.186



Pop P55 Pinocchio p.215



Pop Up 207 p.224

Table lamp



Pop P50 Pinocchio p.214

Suspension



Club C1 mono-color p.26



Club C1 bi-color p.27



Club C2 mono-color p.28



Club C3 mono-color p.29



J&B p.32



J&J p.34



Jo Fly p.36



Jumbo p.39



MoMa mono-color p.43



MoMa bi-color p.45

Filo system:

- Pop Bijou p.56
- C'est Moi p.60
- C'est Toi p.64
- Chérie p.67
- Chapeau p.70
- BonBon p.73
- Petit p.76

Filo system: example of installations from pag. 248 to pag. 251



Pop Bijou p.55



Pop C'est Moi p.59



Pop C'est Toi p.63



Pop Chérie p.66



Pop Chapeau p.69



Pop BonBon p.72



Pop Petit p.75



Pop P06 Ø 6,0- Ø 12,0 p.156



Pop P06 bi-color Ø 6,0 p.158



Pop P06 bi-color Ø 12,0 p.159

Suspension



Pop Host mono-color Ø 32,0

p.201



Pop Host mono-color Ø 80,0

p.202



Pop Host bi-color Ø 32,0

p.205



Pop Host bi-color Ø 80,0

p.206



Pop P40 Chandelier

p.213



Pop P120/P200

p.217



Pop Brooklyn

p.219



Tim T124/T196

p.235



X-Running

p.243

Bic 02 5x5 with trim (for plasterboard and brickwork)

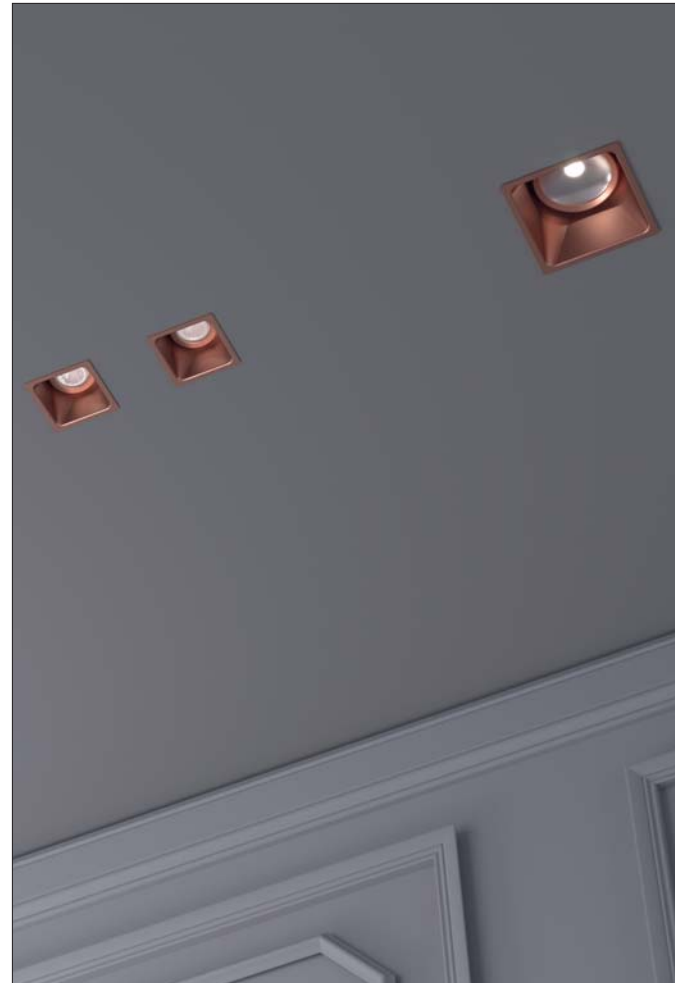

□	Frame
02 ●	Black
06 ○	White
C ●	Copper 15 Working Days
S ●	Brass 15 Working Days

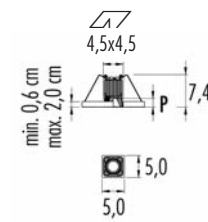

For plasterboard

IP40 ☉	MC-E=3	CE	▽	⊕
500m/A	LED 6W	CRI>90		
3B02.2 ■ S.□	P = 2,0cm	€ 120,00		
4B02.2 ■ S.□	P = 1,5cm	€ 125,00		
<i>With honeycomb</i>				
■ Led color	Nominal lm	Beam spread		
2 = 2700°K	528	22°		
3 = 3000°K	552			
4 = 4000°K	594			

IP54 ☉	MC-E=3	CE	▽	⊕
500m/A	LED 6W	CRI>90		
3B02.2 ■ S9.□	P = 2,0cm	€ 125,00		
■ Led color	Nominal lm	Beam spread		
2 = 2700°K	528	22°		
3 = 3000°K	552			
4 = 4000°K	594			

☉ (m-M)	Driver		
3KIT.500.15 (1-1)	on/off	€ 27,00	
3KIT.501.50 (1-7)	DALI - Push - 1...10V Remote installation	€ 105,00	
3KIT.502.20 (1-3)	DALI Remote installation	€ 59,00	
3KIT.503.20 (1-3)	Push - 1...10 Remote installation	€ 59,00	
3KIT.504.10 (1-1)	IGBT - TRIAC	€ 32,00	

(m-M) = min. Led unit - Max Led unit.
Led and Emergency unit, warranty only when used
together with driver bought from Oty srl.

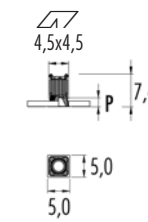

For brickwork

IP40 ☉	MC-E=3	CE	▽	⊕
500m/A	LED 6W	CRI>90		
3B2M.2 ■ S.□	P = 2,0cm	€ 125,00		
4B2M.2 ■ S.□	P = 1,5cm	€ 130,00		
<i>With honeycomb</i>				
■ Led color	Nominal lm	Beam spread		
2 = 2700°K	528	22°		
3 = 3000°K	552			
4 = 4000°K	594			

IP54 ☉	MC-E=3	CE	▽	⊕
500m/A	LED 6W	CRI>90		
3B2M.2 ■ S9.□	P = 2,0cm	€ 130,00		
■ Led color	Nominal lm	Beam spread		
2 = 2700°K	528	22°		
3 = 3000°K	552			
4 = 4000°K	594			

☉ (m-M)	Driver		
3KIT.500.15 (1-1)	on/off	€ 27,00	

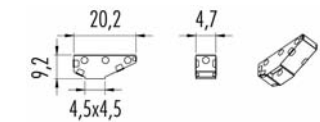

Housing for brickwork

1M02.050.01	€ 34,00
--------------------	---------

(m-M) = min. Led unit - Max Led unit.
Led and Emergency unit, warranty only when used
together with driver bought from Oty srl.

Bic 02 8x8 with trim (for plasterboard and brickwork)



□	Frame
02 ●	Black
06 ○	White
C ●	Copper 15 Working Days
S ●	Brass 15 Working Days

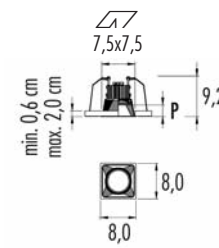

For plasterboard

IP40	MC-E=3	CE	▽	⊕
350m/A	LED 11W	CRI>90		
3B02.3	P = 2,6cm	€ 120,00		
4B02.3	P = 2,1cm	€ 125,00		
<i>With honeycomb</i>				
■ Led color	Nominal lm	▲ Beam spread		
2 = 2700°K	1195	S = 22°		
3 = 3000°K	1257	T = 15°		
4 = 4000°K	1313			

© (m-M)	Driver		
3KIT.350.1L (1-1)	on/off	€ 21,00	
3KIT.351.40 (1-3)	DALI - Push - 1...10V Remote installation	€ 105,00	
3KIT.352.15 (1-1)	DALI	€ 59,00	
3KIT.353.15 (1-1)	Push - 1...10V	€ 59,00	
3KIT.354.18 (1-1)	IGBT - TRIAC	€ 32,00	

Emergency unit: (inverter + battery. Driver not included)

3KIT.900.01 (1-1)	1:00 hour	€ 95,00
3KIT.900.03 (1-1)	3:00 hours	€ 137,00

(m-M) = min. Led unit - Max Led unit.
Led and Emergency unit, warranty only when used
together with driver bought from Oty srl.

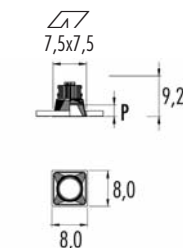

For brickwork

IP40	MC-E=3	CE	▽	⊕
350m/A	LED 11W	CRI>90		
3B2M.3	P = 2,6cm	€ 125,00		
4B2M.3	P = 2,1cm	€ 130,00		
<i>With honeycomb</i>				
■ Led color	Nominal lm	▲ Beam spread		
2 = 2700°K	1195	S = 22°		
3 = 3000°K	1257	T = 15°		
4 = 4000°K	1313			

© (m-M)	Driver		
3KIT.350.1L (1-1)	on/off	€ 21,00	
3KIT.352.15 (1-1)	DALI	€ 59,00	
3KIT.353.15 (1-1)	Push - 1...10V	€ 59,00	
3KIT.354.18 (1-1)	IGBT - TRIAC	€ 32,00	

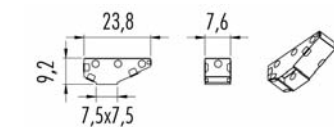

Housing for brickwork

1M02.080.01	€ 36,00
--------------------	---------

(m-M) = min. Led unit - Max Led unit.
Led and Emergency unit, warranty only when used
together with driver bought from Oty srl.

Bic 07 7x7 trimless (only for plasterboard)

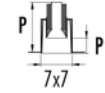

IP40	DimToWarm	CE	V	⊕
220V ÷ 240V	LED 6W	CRI 95		
3B07.3W	IGBT - TRIAC	€ 140,00		
driver included				

Led color	Nominal lm	Beam spread
W = max 3000°K min. 1800°K	max 445 lm min. 10 lm	M = 30° S = 18°

□	Frame
02 ●	Black
06 ○	White

Code	P1	P
B07.210.□	3,6	11,5
B07.220.□	3,1	10,0
B07.3	3,8	13,1
B07.3W	3,8	10,4

IP20	CE	V	⊕
220V ÷ 240V	GU10 max 50W	€ 50,00	
3B07.210.□			

IP20	CE	V	⊕
12V	GU5.3 max 50W	€ 41,00	
3KIT.201.050	max 50VA	€ 32,00	
Dimmable gear: IGBT			

IP40	MC-E=3	CE	V	⊕
350m/A	LED 11W	CRI>90		
3B07.3		€ 120,00		

Led color	Nominal lm	Beam spread
2 = 2700°K	1195	S = 22°
3 = 3000°K	1257	T = 12°
4 = 4000°K	1313	

© (m-M)	Driver	
3KIT.350.1L (1-1)	on/off	€ 21,00
3KIT.351.40 (1-3)	DALI - Push - 1...10V Remote installation	€ 105,00
3KIT.352.15 (1-1)	DALI	€ 59,00
3KIT.353.15 (1-1)	Push - 1...10V	€ 59,00
3KIT.354.18 (1-1)	IGBT - TRIAC	€ 32,00

Emergency unit: (inverter + battery. Driver not included)

3KIT.900.01 (1-1)	1:00 hour	€ 95,00
3KIT.900.03 (1-1)	3:00 hours	€ 137,00

Housing for plasterboard

■	1Z07.070.01	Single	€ 22,00
■ ■	1Z07.070.2L	Double	€ 40,00
■ ■ ■	1Z07.070.3L	Triple	€ 58,00

(m-M) = min. Led unit - Max Led unit.
Led and Emergency unit, warranty only when used
together with driver bought from Oty srl.

Bic 12 12x12 trimless (only for plasterboard)

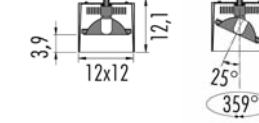
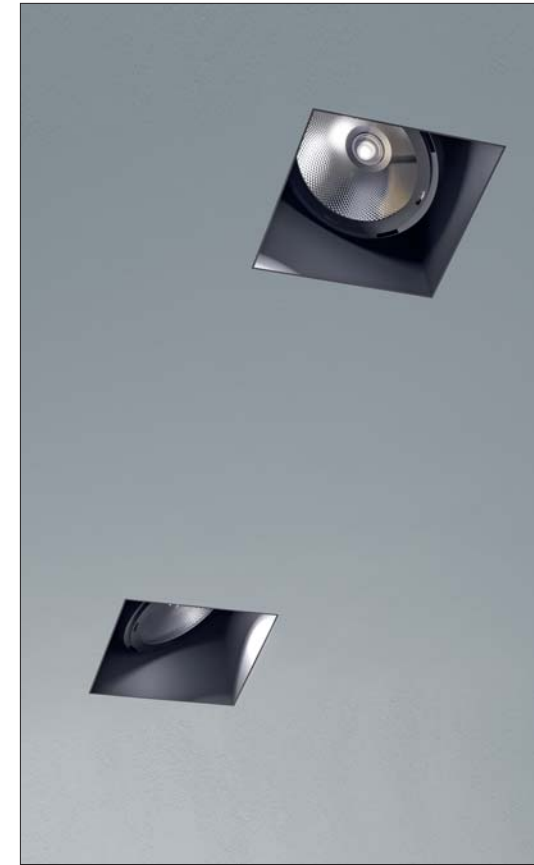

IP20	CE	V	⊕
12V	G53 max 50W	€ 64,00	
3B12.530.□	max 50VA	€ 32,00	
Dimmable gear: IGBT			

IP20	MC-E=3	CE	V	⊕
350 - 500 m/A	LED	CRI>90		
3B12.5		€ 135,00		

© (m-M)	LED 12,5W	350m/A
3KIT.350.1L (1-1)	on/off	€ 21,00
3KIT.351.40 (1-3)	DALI - Push - 1...10V	€ 105,00
3KIT.352.15 (1-1)	DALI	€ 59,00
3KIT.353.15 (1-1)	Push - 1...10V	€ 59,00
3KIT.354.18 (1-1)	IGBT - TRIAC	€ 32,00

Led color	Nominal lm	Beam spread
2 = 2700°K	1477	L = 60°
3 = 3000°K	1565	S = 24°
4 = 4000°K	1635	T = 12°

© (m-M)	LED 18,4W	500m/A
3KIT.500.1L (1-1)	on/off	€ 21,00
3KIT.501.50 (1-3)	DALI - Push - 1...10V	€ 105,00
3KIT.502.20 (1-1)	DALI	€ 59,00
3KIT.503.20 (1-1)	Push - 1...10V	€ 59,00
3KIT.504.20 (1-1)	IGBT - Triac	€ 32,00

Led color	Nominal lm	Beam spread
2 = 2700°K	2020	L = 60°
3 = 3000°K	2140	S = 24°
4 = 4000°K	2236	T = 12°

Emergency unit: (inverter + battery. Driver not included)

3KIT.900.01 (1-1)	1:00 hour	€ 95,00
3KIT.900.03 (1-1)	3:00 hours	€ 137,00

Housing for plasterboard

■	1Z12.120.01	Single	€ 39,00
---	-------------	--------	---------

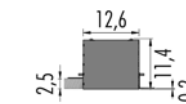

(m-M) = min. Led unit - Max Led unit.
Led and Emergency unit, warranty only when used
together with driver bought from Oty srl.

Bic 16 16x16 trimless (only for plasterboard) ROS

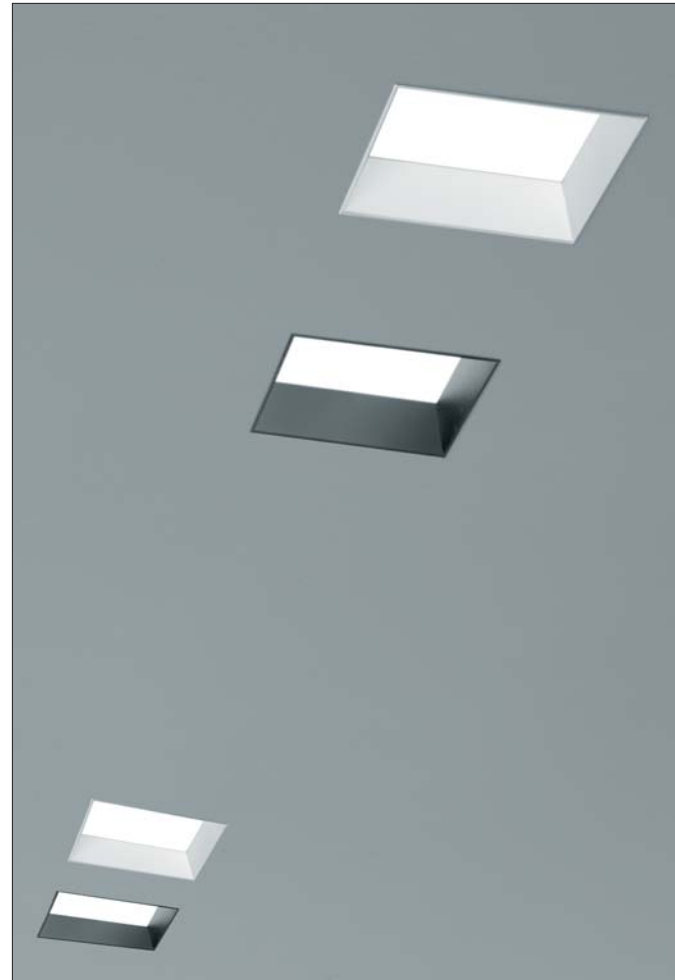

□ Frame

02 ● Black

06 ○ White

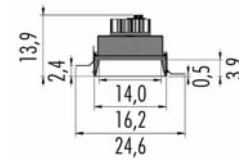

IP20	MC-E=3	CE	▽	⊕
700lm/A	LED 26,2W	CRI>90		
3B16.6	L. □	€ 130,00	▽	
■ Led color	Nominal lm	▲ Beam spread		
2 = 2700°K	3374	104°		
3 = 3000°K	3533			
4 = 4000°K	3649			

© (m-M)	Driver		
3KIT.700.1L (1-1)	on/off	€ 24,00	
3KIT.701.50 (1-1)	DALI - Push - 1...10V	€ 105,00	

Emergency unit: (inverter + battery, Driver not included)

3KIT.900.01 (1-1)	1:00 hour	€ 95,00
3KIT.900.03 (1-1)	3:00 hours	€ 137,00

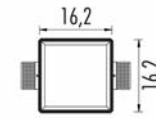

Housing for plasterboard			
■	1Z0B.016.01	Single	€ 49,00

(m-M) = min. Led unit - Max Led unit.
Led and Emergency unit, warranty only when used
together with driver bought from Oty srl.

Bic trimless (only for plasterboard) ROS

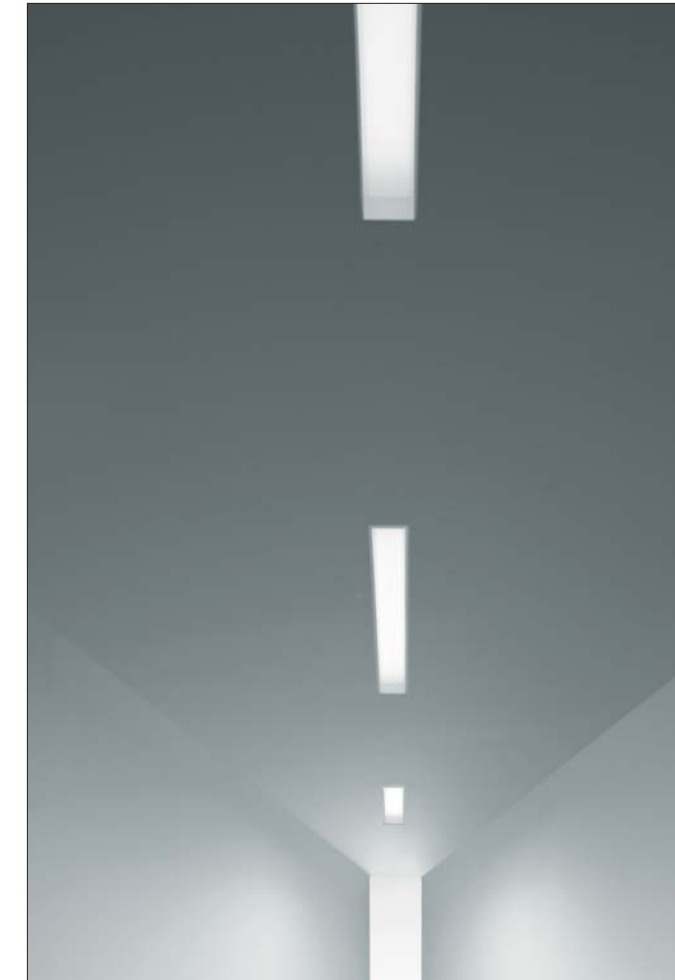

□ Frame

02 ● Black

06 ○ White

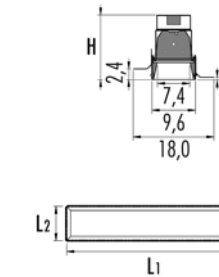

IP44	MC-E=3	CE	▽
220V ÷ 240V	LED 17W	CRI>90	
3BC2.6	L. □	on/off	€ 220,00
■ Led color	Nominal lm	▲ Beam spread	
3 = 3000°K	2030	104°	

1Z0B.025.01	Single	€ 63,00
Housing for plasterboard		

IP44	MC-E=3	CE	▽
220V ÷ 240V	LED 25,6W	CRI>90	
3BC5.6	L. □	on/off	€ 268,00
3BC5.9	L. □	with Emergency	€ 420,00
■ Led color	Nominal lm	▲ Beam spread	
3 = 3000°K	3090	104°	

1Z0B.050.01	Single	€ 72,00
Housing for plasterboard		

IP44	MC-E=3	CE	▽
220V ÷ 240V	LED 34,2W	CRI>90	
3BC6.6	L. □	on/off	€ 284,00
3BC6.9	L. □	with Emergency	€ 430,00
■ Led color	Nominal lm	▲ Beam spread	
3 = 3000°K	4120	104°	

1Z0B.060.01	Single	€ 78,00
Housing for plasterboard		

Code	L1	L2	H
BC2.63L □	25,1	9,6	14,6
BC5.63L □	50,1	9,6	14,6
BC5.93L □	50,1	9,6	15,9
BC6.63L □	60,1	9,6	14,6
BC6.93L □	60,1	9,6	15,9

Bric



<input type="checkbox"/>	Frame
02	● Black
06	○ White
C	● Copper 25 Working Days
S	● Brass 25 Working Days



Bric 20

IP20 ©	MC-E=3	CE ▽
220-240V	8,5W	CRI>90
3BR2.4 ■ L.02	dim. IGBT - TRIAC	€ 210,00
3BR2.4 ■ L.06	dim. IGBT - TRIAC	€ 210,00
3BR2.4 ■ L.C	dim. IGBT - TRIAC	€ 260,00
3BR2.4 ■ L.S	dim. IGBT - TRIAC	€ 260,00
3BR2F4 ■ L.02	DALI - Push	€ 260,00
3BR2F4 ■ L.06	DALI - Push	€ 260,00
3BR2F4 ■ L.C	DALI - Push	€ 300,00
3BR2F4 ■ L.S	DALI - Push	€ 300,00
■ Led color	Nominal lm	Beam spread
2 = 2700°K	1040	92°
3 = 3000°K	1095	

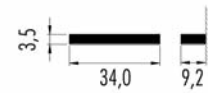

Bric 34

IP20 ©	MC-E=3	CE ▽
220-240V	17W	CRI>90
3BR3.4 ■ L.02	on/off	€ 275,00
3BR3.4 ■ L.06	on/off	€ 275,00
3BR3.4 ■ L.C	on/off	€ 340,00
3BR3.4 ■ L.S	on/off	€ 340,00
■ Led color	Nominal lm	Beam spread
2 = 2700°K	2080	92°
3 = 3000°K	2190	



Bric 62

IP20 ©	MC-E=3	CE ▽
220-240V	34W	CRI>90
3BR6.4 ■ L.02	on/off	€ 445,00
3BR6.4 ■ L.06	on/off	€ 445,00
3BR6.4 ■ L.C	on/off	€ 565,00
3BR6.4 ■ L.S	on/off	€ 565,00
■ Led color	Nominal lm	Beam spread
2 = 2700°K	4165	92°
3 = 3000°K	4385	

micro Box



<input type="checkbox"/>	Frame
02	● Black
04	● Brushed steel
06	● White
08	● Corten painted ROS
09	● Polished steel ROS

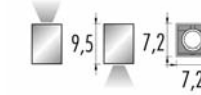

micro Box 7.1

IP20	CE ▽
220-240V	GU10 1x50W
3B71.210.02	€ 75,00
3B71.210.04	€ 85,00
3B71.210.06	€ 75,00
3B71.210.08	€ 80,00
3B71.210.09	€ 95,00

micro Box 7.1

IP20 ©	LED 1x8,7W	CE ▽
220-240V	3000°K 660 lm 70°	CRI>90
3B71.335.02	dim. IGBT	€ 134,00
3B71.335.04	dim. IGBT	€ 145,00
3B71.335.06	dim. IGBT	€ 134,00
3B71.335.08	dim. IGBT	€ 134,00
3B71.335.09	dim. IGBT	€ 161,00



micro Box 7.2

IP20	CE ▽
220-240V	GU10 2x50W
3B72.210.02	€ 95,00
3B72.210.04	€ 108,00
3B72.210.06	€ 95,00
3B72.210.08	€ 100,00
3B72.210.09	€ 130,00

micro Box 7.2

IP20 ©	LED 2x8,7W	CE ▽
220-240V	3000°K 2x660 lm 70°	CRI>90
3B72.335.02	dim. IGBT	€ 215,00
3B72.335.04	dim. IGBT	€ 235,00
3B72.335.06	dim. IGBT	€ 215,00
3B72.335.08	dim. IGBT	€ 215,00
3B72.335.09	dim. IGBT	€ 255,00

Box



□ Frame

- 02 ● Black
 04 ● Brushed steel
 06 ○ White
 09 ● Polished steel



Code	L	H	P
BOX23	23,0	8,5	7,2
BOX31	31,0	8,5	7,2
BOX50	50,0	8,5	7,2
BOX63	63,0	8,5	7,2
BOX120	120,0	8,5	7,2

Box 23 cm

IP20	RDS	CE	▽
220-240V	R7S 74,9mm	1x80W	
3B23.510.02		€ 132,00	
3B23.510.04		€ 144,00	
3B23.510.06		€ 132,00	
3B23.510.09		€ 160,00	

IP40	RDS	CE	▽
220-240V	G24Q-2 1x18W	Electronic ballast	
3B23.100.02		€ 129,00	
3B23.100.04		€ 145,00	
3B23.100.06		€ 129,00	
3B23.100.09		€ 161,00	

IP40	MC-E=3	CE	▽
220-240V	LED 2x6,8W	CRI>90	
3B23.5 L.02	on/off	€ 200,00	
3B23.5 L.04	on/off	€ 210,00	
3B23.5 L.06	on/off	€ 200,00	
3B23.5 L.09	on/off	€ 220,00	

■ Led color
 3 = 3000°K

Nominal lm
 2x826

Beam spread
 90°

Box 31 cm

IP20	RDS	CE	▽
220-240V	R7S 74,9mm	1x120W	
3B31.510.02		€ 135,00	
3B31.510.04		€ 144,00	
3B31.510.06		€ 135,00	
3B31.510.09		€ 181,00	

IP40	RDS	CE	▽
220-240V	G24Q-3 1x26W	Electronic ballast	
3B31.100.02		€ 140,00	
3B31.100.04		€ 150,00	
3B31.100.06		€ 140,00	
3B31.100.09		€ 183,00	

IP40	MC-E=3	CE	▽
220-240V	LED 2x9,0W	CRI>90	
3B31.5 L.02	on/off	€ 220,00	
3B31.5 L.04	on/off	€ 230,00	
3B31.5 L.06	on/off	€ 220,00	
3B31.5 L.09	on/off	€ 240,00	

IP40	MC-E=3	CE	▽
220-240V	LED 2x9,0W	CRI>90	
3B31F5 L.02	DALI - Push	€ 260,00	
3B31F5 L.04	DALI - Push	€ 270,00	
3B31F5 L.06	DALI - Push	€ 260,00	
3B31F5 L.09	DALI - Push	€ 280,00	

IP40	MC-E=3	CE	▽
220-240V	LED 2x9,0W	CRI>90	
3B31G5 L.02	1...10V - Push	€ 260,00	
3B31G5 L.04	1...10V - Push	€ 270,00	
3B31G5 L.06	1...10V - Push	€ 260,00	
3B31G5 L.09	1...10V - Push	€ 280,00	

■ Led color
 3 = 3000°K

Nominal lm
 2x1102

Beam spread
 90°

Box 50 cm

IP20	RDS	CE	▽
220-240V	R7S 74,9mm	2x80W	
3B50.510.02		€ 170,00	
3B50.510.04		€ 186,00	
3B50.510.06		€ 170,00	
3B50.510.09		€ 238,00	

IP40	RDS	CE	▽
220-240V	G211 1x36W	Electronic ballast	
3B50.100.02		€ 190,00	
3B50.100.04		€ 206,00	
3B50.100.06		€ 190,00	
3B50.100.09		€ 234,00	

IP40	MC-E=3	CE	▽
220-240V	LED 2x13,5W	CRI>90	
3B50.5 L.02	on/off	€ 300,00	
3B50.5 L.04	on/off	€ 310,00	
3B50.5 L.06	on/off	€ 300,00	
3B50.5 L.09	on/off	€ 320,00	

IP40	MC-E=3	CE	▽
220-240V	LED 2x13,5W	CRI>90	
3B50E5 L.02	DALI - Push - 1...10V	€ 350,00	
3B50E5 L.04	DALI - Push - 1...10V	€ 360,00	
3B50E5 L.06	DALI - Push - 1...10V	€ 350,00	
3B50E5 L.09	DALI - Push - 1...10V	€ 370,00	

IP40	MC-E=3	CE	▽
220-240V	LED 2x13,5W	CRI>90	
3B50.9 L.02	with Emergency	€ 450,00	
3B50.9 L.04	with Emergency	€ 460,00	
3B50.9 L.06	with Emergency	€ 450,00	
3B50.9 L.09	with Emergency	€ 470,00	

■ Led color
 3 = 3000°K

Nominal lm
 2x1653

Beam spread
 90°

Box 63 cm

IP20	RDS	CE	▽
220-240V	R7S 74,9mm	3x80W	
3B63.510.02		€ 210,00	
3B63.510.04		€ 241,00	
3B63.510.06		€ 210,00	
3B63.510.09		€ 289,00	

IP40	RDS	CE	▽
220-240V	G211 1x55W	Electronic ballast	
3B63.100.02		€ 210,00	
3B63.100.04		€ 240,00	
3B63.100.06		€ 210,00	
3B63.100.09		€ 262,00	

IP40	MC-E=3	CE	▽
220-240V	LED 2x18,2W	CRI>90	
3B63.5 L.02	on/off	€ 330,00	
3B63.5 L.04	on/off	€ 340,00	
3B63.5 L.06	on/off	€ 330,00	
3B63.5 L.09	on/off	€ 350,00	

IP40	MC-E=3	CE	▽
220-240V	LED 2x18,2W	CRI>90	
3B63E5 L.02	DALI - Push - 1...10V	€ 410,00	
3B63E5 L.04	DALI - Push - 1...10V	€ 420,00	
3B63E5 L.06	DALI - Push - 1...10V	€ 410,00	
3B63E5 L.09	DALI - Push - 1...10V	€ 420,00	

IP40	MC-E=3	CE	▽
220-240V	LED 2x18,2W	CRI>90	
3B63.9 L.02	with Emergency	€ 470,00	
3B63.9 L.04	with Emergency	€ 480,00	
3B63.9 L.06	with Emergency	€ 470,00	
3B63.9 L.09	with Emergency	€ 490,00	

■ Led color
 3 = 3000°K

Nominal lm
 2x2205

Beam spread
 90°

Box 120 cm

IP20	RDS	CE	▽
220-240V	G5 2x54W	Electronic ballast	
3B120.100.02		€ 400,00	▼
3B120.100.04		€ 439,00	▼
3B120.100.06		€ 400,00	▼
3B120.100.09		€ 487,00	▼

IP40	MC-E=3	CE	▽
220-240V	LED 2x63,6W	CRI>90	
3B120.4 L.02	on/off	€ 640,00	▼
3B120.4 L.04	on/off	€ 670,00	▼
3B120.4 L.06	on/off	€ 640,00	▼
3B120.4 L.09	on/off	€ 735,00	▼

■ Led color
 3 = 3000°K

Nominal lm
 2x4740

Beam spread
 90°

Club C1 mono-color

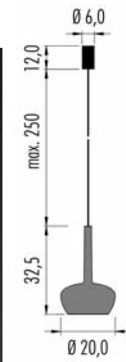

IP20	☉	CE	▽
220-240V	9W	CRI>90	
3C1C.2	■ L. □ on/off	€ 430,00	
■ Led color	Nominal lm	Beam spread	
2 = 2700 °K	1155	60°	

□	Frame	Canopy
02	● Black	Black
06	○ White	Black
B	● Blue	Black
G	● Green	Black
P	● Rose	Black
R	● Red	Black

Time delivery: 25 Working Days
Black coaxial power supply cable

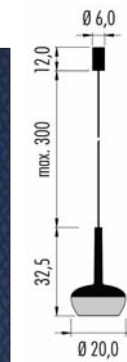
Club C1 bi-color ROS

IP20	☉	CE	▽
220-240V	9W	CRI>90	
3C1C.2	■ L. □ on/off	€ 550,00	
■ Led color	Nominal lm	Beam spread	
2 = 2700 °K	1155	60°	

□	Up	Down	Diffuser color	Canopy
CB	●	●	Copper/Blue	Black
CG	●	●	Copper/Green	Black
CP	●	●	Copper/Rose	Black
CR	●	●	Copper/Red	Black

Time delivery: 25 Working Days
Black coaxial power supply cable

Club C2 mono-color

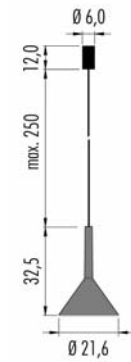

IP20	©	CE	▽
220-240V	9W	CRI>90	
3C2C.2	L. □ on/off	€ 430,00	
■ Led color	Nominal lm	Beam spread	
2 = 2700°K	1155	60°	

□	Frame	Canopy
02	● Black	Black
06	○ White	Black
B	● Blue	Black
G	● Green	Black
P	● Rose	Black
R	● Red	Black

Time delivery: 25 Working Days
Black coaxial power supply cable

Club C3 mono-color

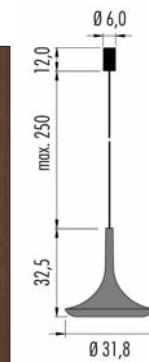

IP20	©	CE	▽
220-240V	9W	CRI>90	
3C3C.2	L. □ on/off	€ 430,00	
■ Led color	Nominal lm	Beam spread	
2 = 2700°K	1155	60°	

□	Frame	Canopy
02	● Black	Black
06	○ White	Black
B	● Blue	Black
G	● Green	Black
P	● Rose	Black
R	● Red	Black

Time delivery: 25 Working Days
Black coaxial power supply cable

e-PAD

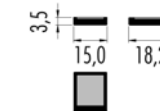
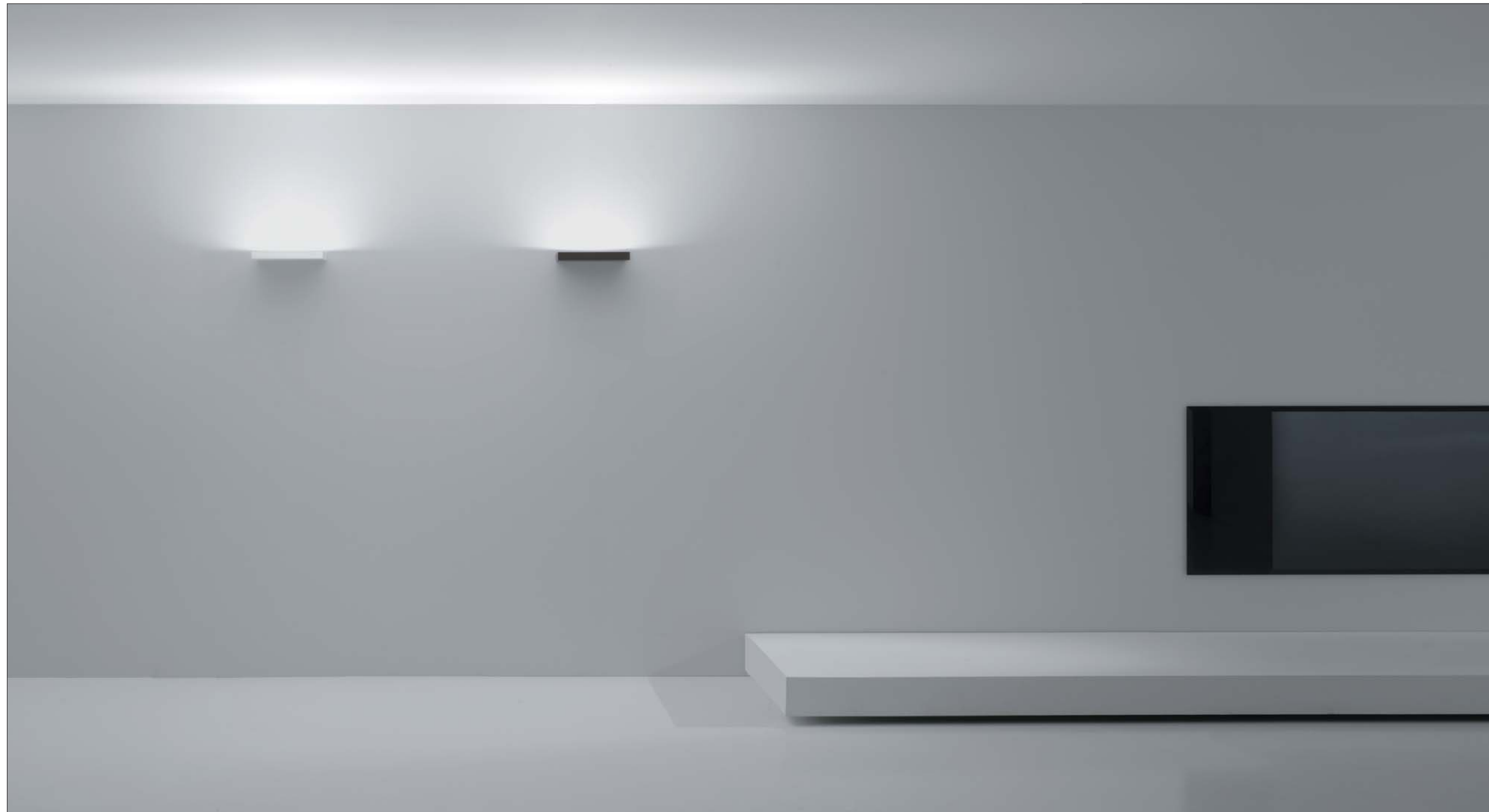
**e - PAD 15**

IP20	MC-E=3	CE
220-240V	LED 1x18W	CRI>90
3E15.5 L.□	dimm. IGBT - TRIAC	€ 231,00
■ Led color	Nominal lm	Beam spread
2 = 2700°K	2494	105°
3 = 3000°K	2611	
4 = 4000°K	2697	

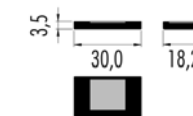
**e - PAD 30**

IP20	MC-E=3	CE
220-240V	LED 2x18W	CRI>90
3E30.5 L.□	dimm. IGBT - TRIAC	€ 332,00
3E30.7 L.□	DALI - Push - 1...10V	€ 390,00
■ Led color	Nominal lm	Beam spread
2 = 2700°K	2x2494	105°
3 = 3000°K	2x2611	
4 = 4000°K	2x2697	

□	Frame
02 ●	Black
06 ○	White

J & B

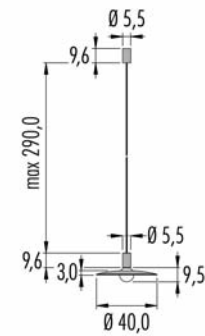

IP20	CE	CE
220-240V	e27 4W	CRI>80
3JB1.12L	dim. IGBT-Triac	€ 250,00
Led color	Nominal lm	Beam spread
2700°K	470	360°

	Canopy/Wire	Cylinder	Diffuser
02	● Black	● Black	● Black
KSK	● Black	● Brass Anodized	● Black
06	○ White	○ White	○ White
WSW	○ White	● Brass Anodized	○ White

Available from 15/10/2019

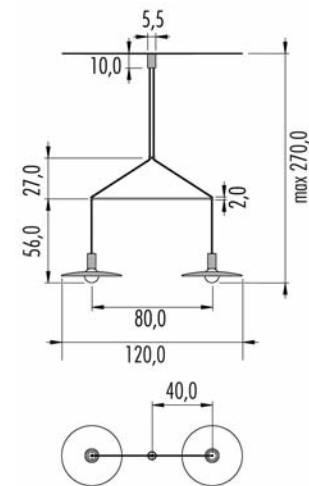

IP20	CE	CE
220-240V	e27 2x4W	CRI>80
3JB2.12L	dim. IGBT-Triac	€ 650,00
Led color	Nominal lm	Beam spread
2700°K	2x470	360°

	Canopy/Wire	Spacer	Cylinder	Diffuser
02	● Black	● Brass	● Black	● Black
KSK	● Black	● Brass	● Brass Anodized	● Black
06	○ White	● Brass	○ White	○ White
WSW	○ White	● Brass	● Brass Anodized	○ White

Available from 15/10/2019



J & J

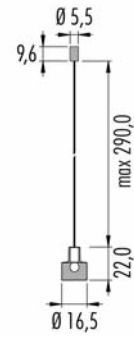

IP20	Ⓢ	CE	▽
220-240V	e27 4W	CRI>80	
3JJ1.12L	□ dimm. IGBT - Triac	€ 320,00	
Led color	Nominal lm	Beam spread	
2700°K	470	360°	

	Canopy/Wire	Cylinder	Glass
KSF	● Black	● Brass Anodized	● Fumé
WSH	○ White	● Brass Anodized	● Champagne

Available from 15/10/2019

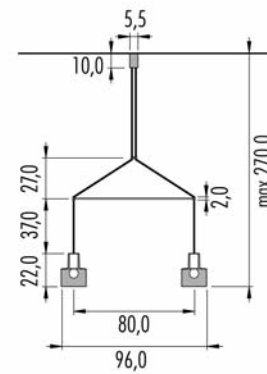

IP20	Ⓢ	CE	▽
220-240V	e27 2x4W	CRI>80	
3JJ2.12L	□ dimm. IGBT - Triac	€ 830,00	
Led color	Nominal lm	Beam spread	
2700°K	2x470	360°	

	Canopy/Wire	Spacer	Cylinder	Diffuser
KSF	● Black	● Brass	● Brass Anodized	● Fumé
WSH	○ White	● Brass	● Brass Anodized	● Champagne

Available from 15/10/2019



Jo Fly

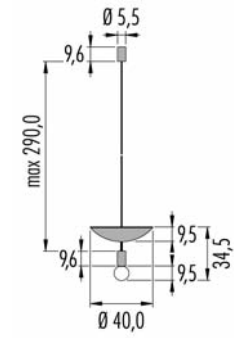

IP20	Ⓛ	CE	▽
220-240V	e27 6W	CRI>90	
3JF1.12L.02	dimm. IGBT - Triac	€ 310,00	
3JF1.12L.06	dimm. IGBT - Triac	€ 310,00	
Led color	Nominal lm	Beam spread	
2700°K	540	360°	

	Canopy/Wire	Diffuser	Bulb
02	● Black	● Black	○ White porcelain
06	○ White	○ White	○ White porcelain

Available from 15/10/2019



Jumbo J07

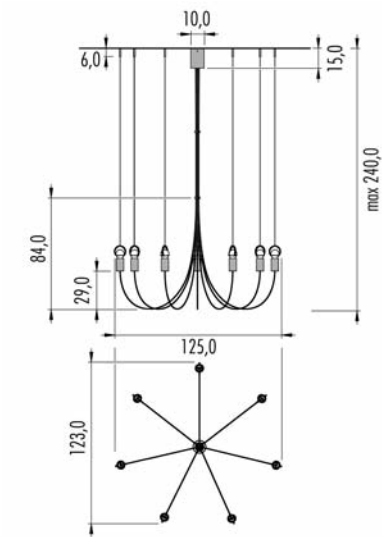

IP20	Ⓛ	CE	▽
220-240V	e27 7x4W	CRI>80	
3J07.12L	dimm. IGBT-Triac	€ 1.200,00	
Led color	Nominal lm	Beam spread	
2700°K	7x470	360°	

	Wire	Cylinder for Bulb
O2	● Black	● Black
KS1	● Black	● Brass Anodized

Time delivery: 25 Working days
Available from 15/10/2019

Jumbo J14

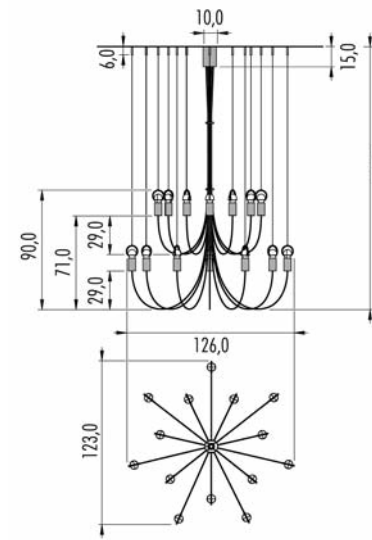
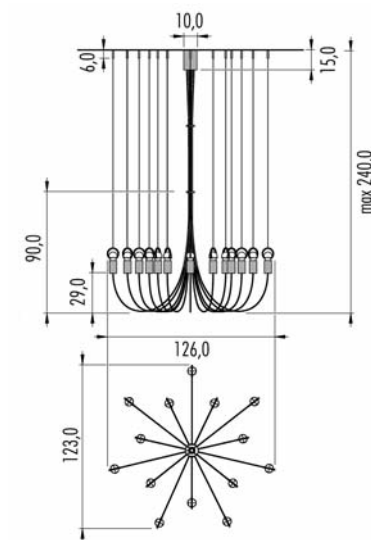

IP20	Ⓛ	CE	▽
220-240V	e27 14x4W	CRI>80	
3J14.12L	□ dimm. IGBT-Triac	€ 2.200,00	
Led color	Nominal lm	Beam spread	
2700°K	14x470	360°	

- Wire Cylinder for Bulb
- O2 ● Black ● Black
 - KS1 ● Black ● Brass Anodized

Time delivery: 25 Working days
Available from 15/10/2019

MoMa mono-color **New**

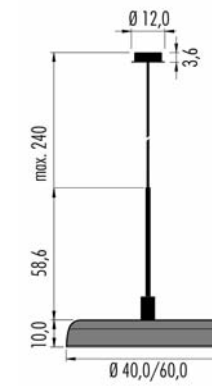

IP20	Ⓛ	CE	∇
220-240V	e27	7W	CRI>80
dimmable IGBT - Triac			
3M40C.12L.06	Ø 40cm	€ 375,00	
3M60C.12L.06	Ø 60cm	€ 420,00	
Led color	Nominal lm	Beam spread	
2700°K	806	163°	

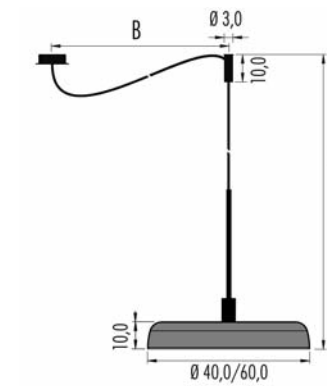

IP20	Ⓛ	A+B=410cm	CE	∇
220-240V	e27	7W	CRI>80	dimmable IGBT - Triac
3M40D.12L.06	Ø 40cm	€ 400,00		
3M60D.12L.06	Ø 60cm	€ 445,00		
Led color	Nominal lm	Beam spread		
2700°K	806	163°		

	Frame	Bulb	CUP canopy	cable
06	○ White	● Mirror Chrome	White	White

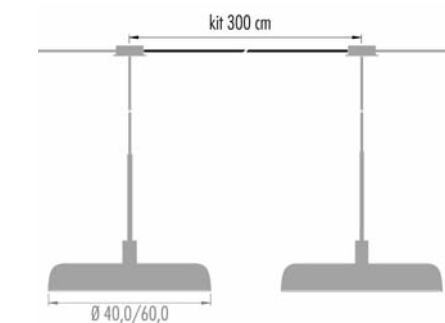

Kit Cable for MoMa composition			
1KIT.300.06	White	€ 36,00	

MoMa bi-color

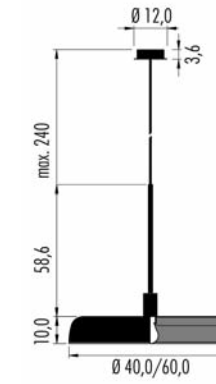

IP20	Ⓛ	CE	▽	
220-240V	e27	4W	CRI>80	dimnable IGBT - Triac
3M40C.12L.	□	Ø 40cm	€ 630,00	
3M60C.12L.	□	Ø 60cm	€ 695,00	
Led color	Nominal lm	Beam spread		
2700°K	470	163°		

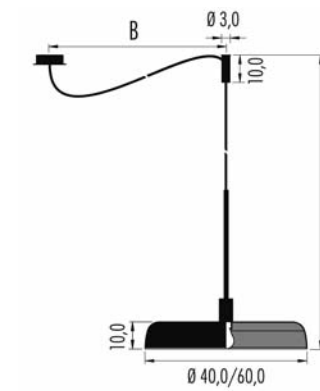

IP20	Ⓛ	A+B=410cm	CE	▽
220-240V	e27	4W	CRI>80	dimnable IGBT - Triac
3M40D.12L.	□	Ø 40cm	€ 715,00	
3M60D.12L.	□	Ø 60cm	€ 780,00	
Led color	Nominal lm	Beam spread		
2700°K	470	163°		

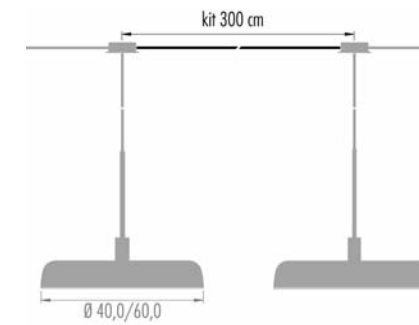

Kit Cable for MoMa composition		
1KIT.300.C	Copper L. 300cm	€ 50,00

	Out	In	CUP	cable	Bulb
KC	●	●	Black/Copper	Black Copper	● Transparent
WC	●	●	White/Copper	White Copper	● Transparent
BC	●	●	Blue/Copper	Blue Copper	● Transparent
GC	●	●	Green/Copper	Green Copper	● Transparent
PC	●	●	Rose/Copper	Rose Copper	● Transparent
RC	●	●	Red/Copper	Red Copper	● Transparent

Time delivery: 25 Working Days

MoMa W bi-color wall/ceiling

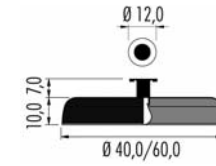

IP20	Ⓢ	CE	▽	
220-240V	e27	4W	CRI>80	dimmable IGBT - Triac
3M40W.12L.	□	Ø 40cm	€ 480,00	
3M60W.12L.	□	Ø 60cm	€ 540,00	
Led color	Nominal lm	Beam spread		
2700°K	470	163°		

□	Out	In	Bulb		
KC	●	●	Black/Copper	●	Transparent
WC	●	●	White/Copper	●	Transparent
BC	●	●	Blue/Copper	●	Transparent
GC	●	●	Green/Copper	●	Transparent
PC	●	●	Rose/Copper	●	Transparent
RC	●	●	Red/Copper	●	Transparent

Time delivery: 25 working days



MoMa L/M bi-color

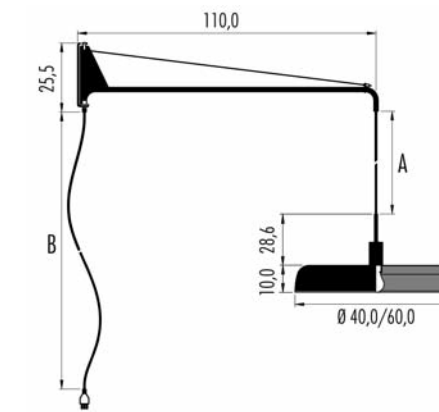

IP20	Ⓛ	A+B=300cm	CE	▽
220-240V	e27	4W CRI>80	dimnable IGBT - Triac	
3M40L.12L.	□	Ø 40cm	€ 910,00	
3M60L.12L.	□	Ø 60cm	€ 970,00	
Led color	Nominal lm	Beam spread		
2700°K	470	163°		

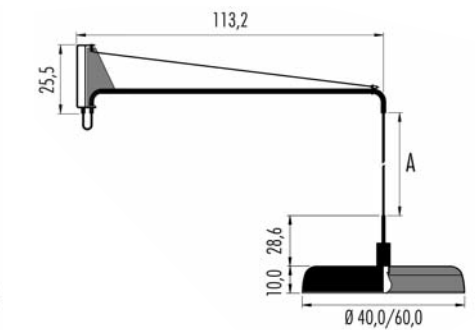

IP20	Ⓛ	A=130cm	CE	▽
220-240V	e27	4W CRI>80	dimnable IGBT - Triac	
3M40M.12L.	□	Ø 40cm	€ 980,00	
3M60M.12L.	□	Ø 60cm	€ 1.040,00	
Led color	Nominal lm	Beam spread		
2700°K	470	163°		

□	Out	In	Frame	cable	Bulb	
KC	●	●	Black/Copper	Black	Copper	Transparent
WC	●	●	White/Copper	White	Copper	Transparent
BC	●	●	Blue/Copper	Blue	Copper	Transparent
GC	●	●	Green/Copper	Green	Copper	Transparent
PC	●	●	Rose/Copper	Rose	Copper	Transparent
RC	●	●	Red/Copper	Red	Copper	Transparent

Time delivery: 25 Working Days

Nelly

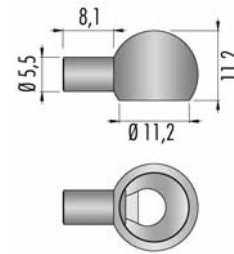
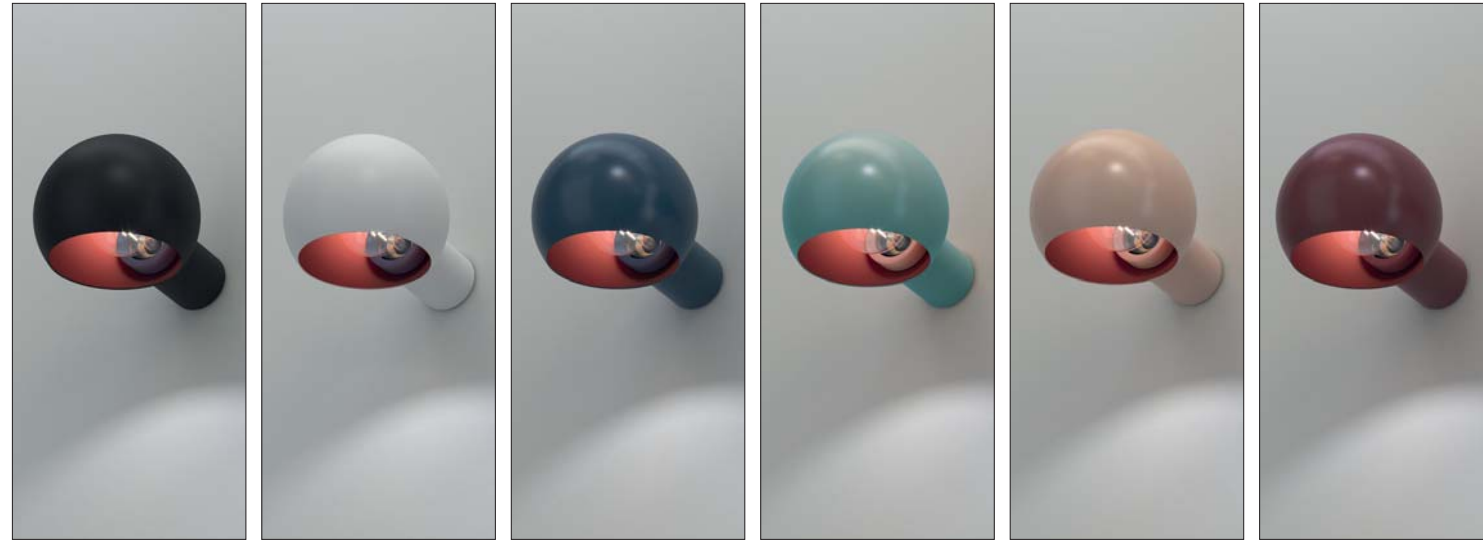

IP20	Ⓢ	CE	∇
220-240V	e27 4W	CRI>80	
3N01.12L	□ dimm. IGBT - Triac	€ 270,00	
Led color 2700°K	Nominal lm 470	Beam spread 40°	

□	Out	In	Bulb		
KC	●	●	Black/Copper	○	Transparent
WC	●	●	White/Copper	○	Transparent
BC	●	●	Blue/Copper	○	Transparent
GC	●	●	Green/Copper	○	Transparent
PC	●	●	Rose/Copper	○	Transparent
RC	●	●	Red/Copper	○	Transparent

Time delivery: 25 Working days
Available from 30/09/2019



Nemo

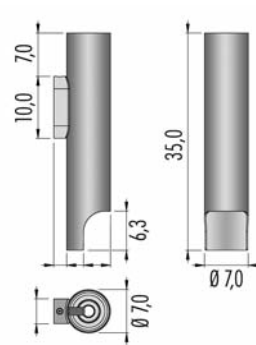
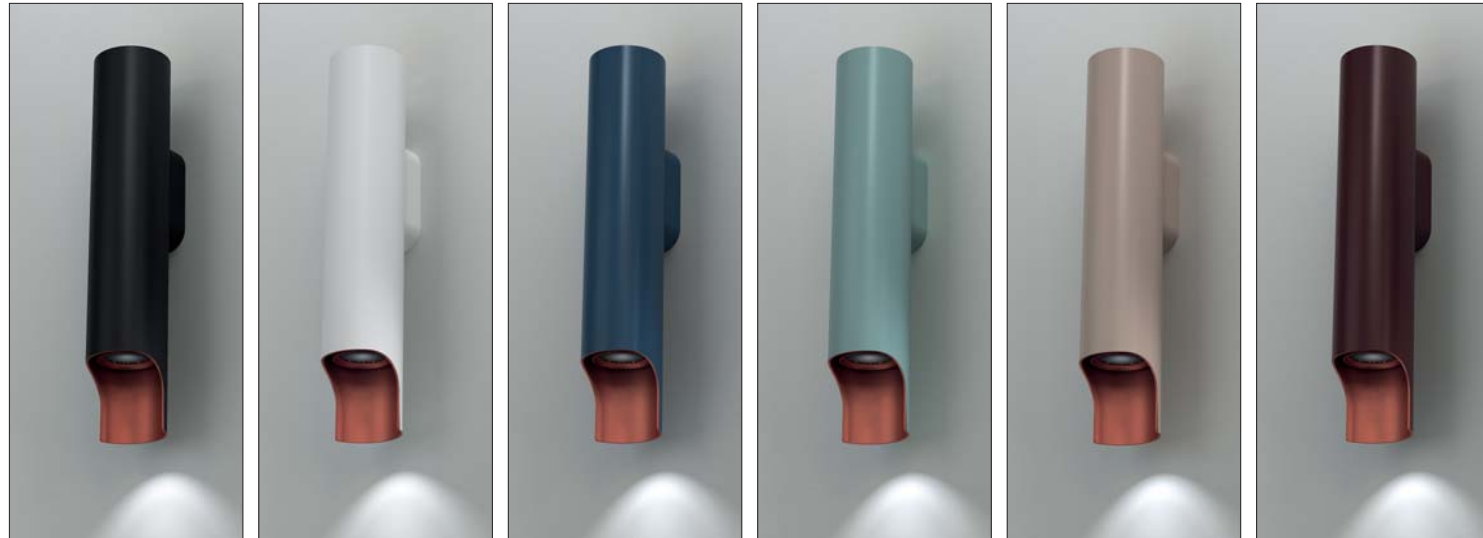

IP20	Flicker < 20%	CE	MC-E=3
220-240V	9,5W CRI>90	dimm. IGBT - TRIAC	
4N05.K2S.KC	With honeycomb	€ 230,00	
4N05.K2S.WC	With honeycomb	€ 230,00	
4N05.K2S.BC	With honeycomb	€ 290,00	
4N05.K2S.GC	With honeycomb	€ 290,00	
4N05.K2S.PC	With honeycomb	€ 290,00	
4N05.K2S.RC	With honeycomb	€ 290,00	
Led color	Nominal lm	Beam spread	
2700°K	710	24°	

<input type="checkbox"/>	Out	In	
KC			Black/Copper
WC			White/Copper
BC			Blue/Copper
GC			Green/Copper
PC			Rose/Copper
RC			Red/Copper

Time delivery: 25 Working days
Available from 30/09/2019

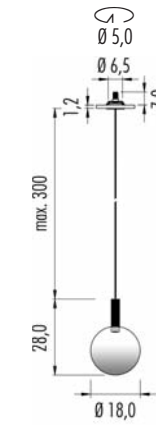

Pop Bijou *New*

IP40	©	ARC	CE	▽
220-240V		6W CRI>90	dimmable IGBT - Triac	
3BUA.2	■ S. □		€ 350,00	
■ Led color		Nominal lm	Beam spread	
2 = 2700°K		528	25°	
3 = 3000°K		552		

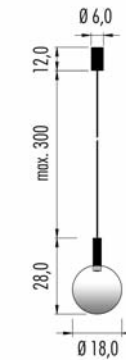

IP40	©	CUP	CE	▽
220-240V		6W CRI>90	on/off	
3BUC.2	■ S. □		€ 360,00	
■ Led color		Nominal lm	Beam spread	
2 = 2700°K		528	25°	
3 = 3000°K		552		

□	Cylinder	ARC canopy	CUP canopy
02	● Black	White	Black
06	○ White	White	Black
C1	● Copper Anodized	White	Black
S1	● Brass Anodized	White	Black

Black coaxial power supply cable. Time delivery: 25 Working Days
 Available from 30/09/2019
 Collection 2018 available until run out of stock.

Filo System - Pop Bijou *New*

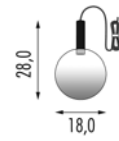

IP40	CE	CE	∇
500 mA	6W	CRI>90	
3BU1.2 S.□	12m Cable	€ 320,00	
3BU2.2 S.□	22m Cable	€ 400,00	
Led color	Nominal lm	Beam spread	
2 = 2700°K	528	25°	
3 = 3000°K	552		

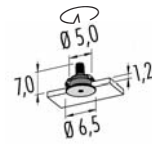

ARC Canopy	for max 1 diffuser	White painted
3FL5.ARC.06	IGBT - Triac	€ 105,00



CUP Canopy	min. 3 max 12 diffusers	Black painted
3FL5.029.02	on/off	€ 360,00
3FL5.C29.02	0/1...10V	€ 450,00
3FL5.F29.02	DALI - Push	€ 450,00



CUP Canopy	for max 2 diffusers	Black painted
3FL5.CUP.02	IGBT - Triac	€ 200,00

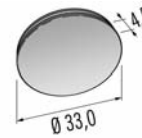

CUP Canopy	min. 6 max 24 diffusers	Black painted
3FL5.033.02	On/off	€ 550,00
3FL5.E33.02	DALI - Push - 0/1...10V	€ 650,00



CUP with Plug-in	for max 1 diffuser	Black painted
3FL5.PIN.02	On/off	€ 195,00

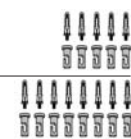

Wall - Ceiling Mounting		
1KIT.WM5.02	5 units Black	€ 16,00
1KIT.WM8.02	8 units Black	€ 25,00

Example 1 (18+18 art. Bijou)= 2 Cup Ø cm. 33

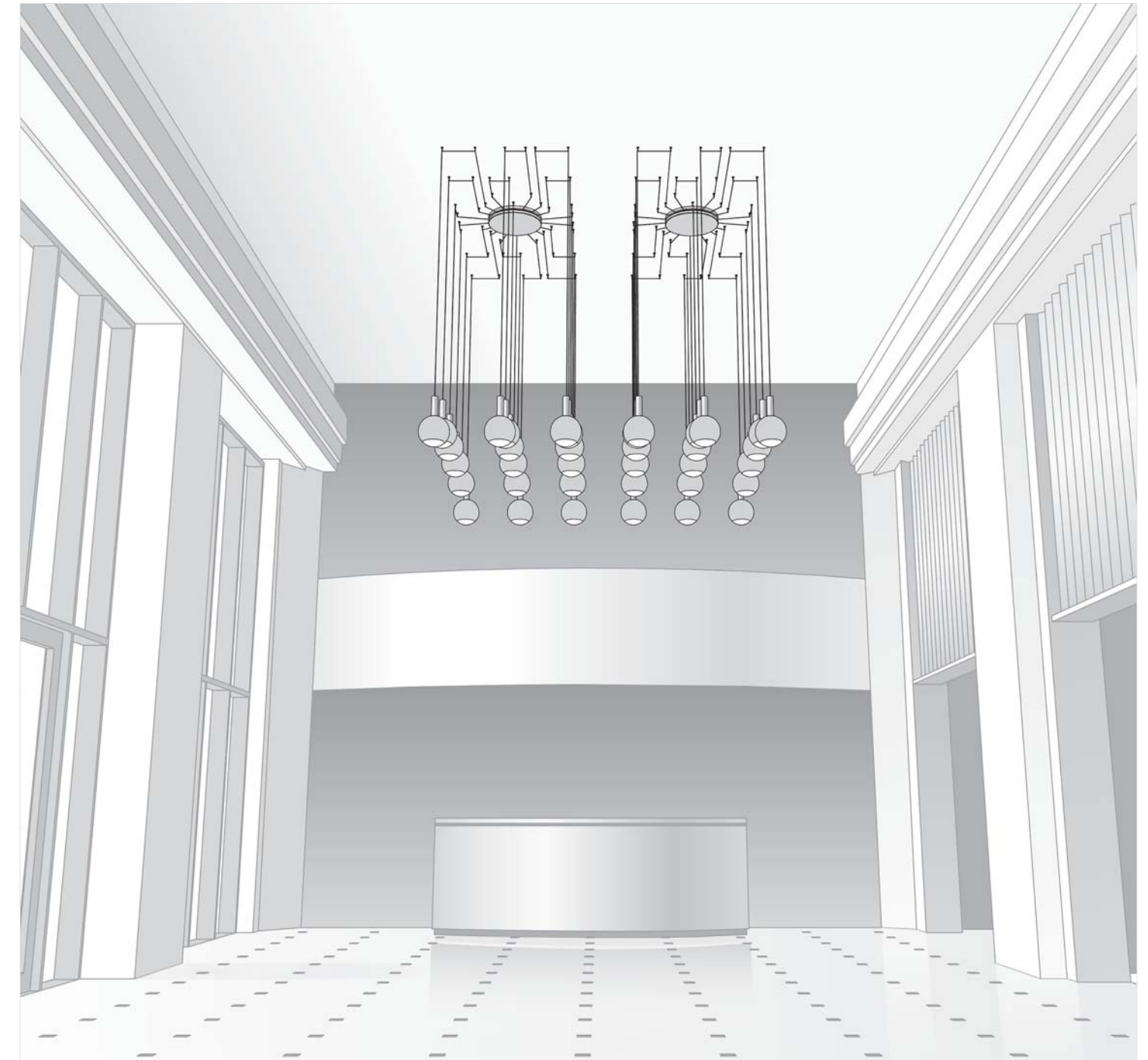

Pop C'est Moi

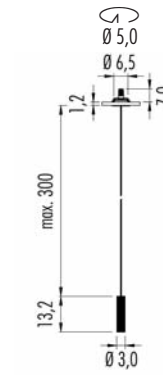

IP20 ©	ARC	CE ▽
220-240V	6W CRI>90	dimnable IGBT - Triac
3CMA.2 ■ S. □		€ 325,00
■ Led color	Nominal lm	Beam spread
2 = 2700 °K	528	20°
3 = 3000 °K	552	

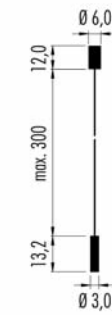

IP20 ©	CUP	CE ▽
220-240V	6W CRI>90	on/off
3CMC.2 ■ S. □		€ 325,00
■ Led color	Nominal lm	Beam spread
2 = 2700 °K	528	20°
3 = 3000 °K	552	

□	Diffuser color	ARC canopy	CUP canopy
02 ●	Black	White	Black
06 ○	White	White	Black
B ●	Blue	White	Black
C ●	Copper	White	Black
G ●	Green	White	Black
P ●	Rose	White	Black
R ●	Red	White	Black

Black coaxial power supply cable. Time delivery: 25 Working Days

Filo System - Pop C'est Moi

	IP20	CE	
	500 mA	6W	CRI>90
	3CM1.2 S. □	12m Cable	€ 295,00
	3CM2.2 S. □	22m Cable	€ 387,00
	Led color	Nominal lm	Beam spread
	2 = 2700°K	528	20°
	3 = 3000°K	552	

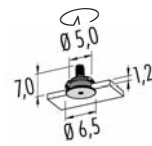

ARC Canopy ©	for max 1 diffuser	White painted
3FL5.ARC.06	IGBT - Triac	€ 105,00



CUP Canopy ©	for max 2 diffusers	Black painted
3FL5.CUP.02	IGBT - Triac	€ 200,00



CUP with Plug-in ©	for max 1 diffuser	Black painted
3FL5.PIN.02	On/off	€ 195,00

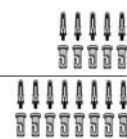

<i>Wall - Ceiling Mounting</i>		
1KIT.WM5.02	5 units Black	€ 16,00
1KIT.WM8.02	8 units Black	€ 25,00

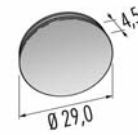

CUP Canopy ©	min. 3 max 12 diffusers	Black painted
3FL5.029.02	on/off	€ 360,00
3FL5.C29.02	0/1...10V	€ 450,00
3FL5.F29.02	DALI - Push	€ 450,00

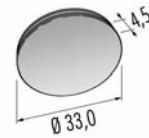

CUP Canopy ©	min. 6 max 24 diffusers	Black painted
3FL5.033.02	On/off	€ 550,00
3FL5.E33.02	DALI - Push - 0/1...10V	€ 650,00

Example 2 (6 art. C'est Moi) = Cup Ø cm. 29

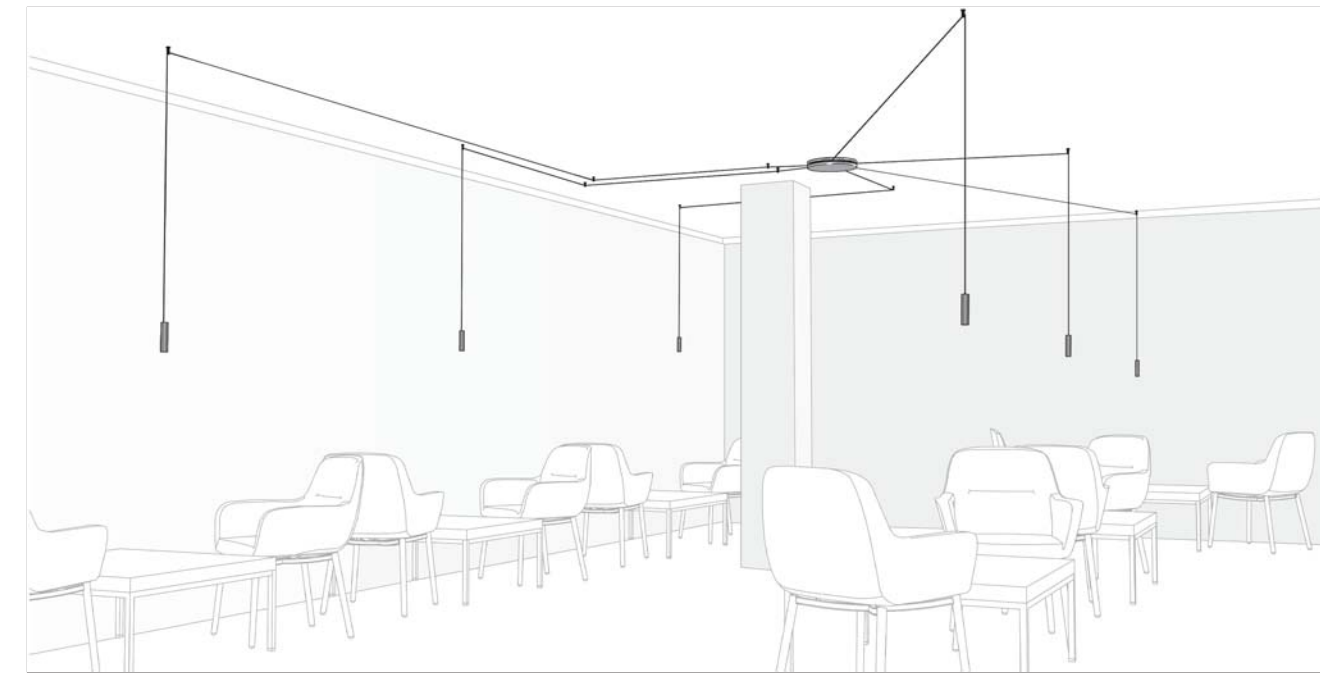

Example 3 (9 art. C'est Moi) = Cup Ø cm. 29

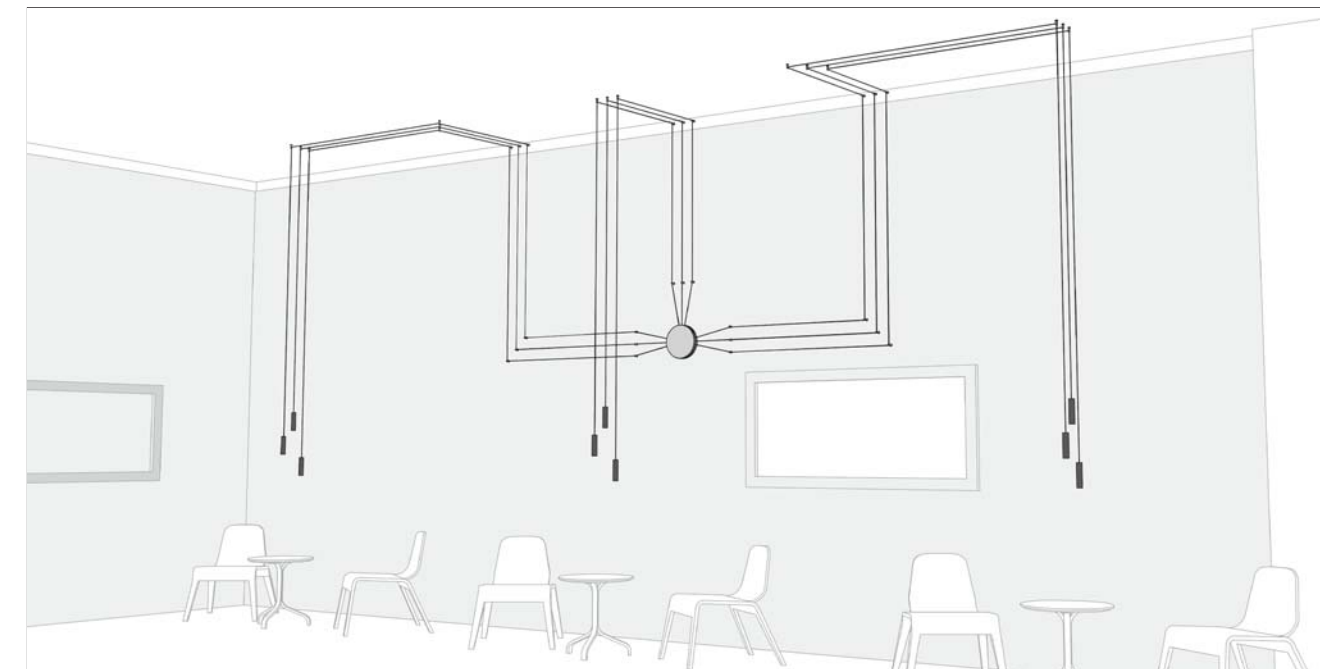

Pop C'est Toi

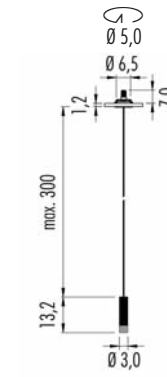

IP20 ©	ARC	CE ▽
220-240V	6W CRI>90	dimnable IGBT - Triac
3CTA.2 ■ S. □		€ 280,00
■ Led color	Nominal lm	Beam spread
2 = 2700 °K	528	20°
3 = 3000 °K	552	

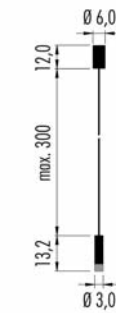

IP20 ©	CUP	CE ▽
220-240V	6W CRI>90	on/off
3CTC.2 ■ S. □		€ 290,00
■ Led color	Nominal lm	Beam spread
2 = 2700 °K	528	20°
3 = 3000 °K	552	

□	Diffuser color	ARC canopy	CUP canopy
02 ●	Black	White	Black
06 ○	White	White	Black
C1 ●	Copper Anodized	White	Black
S1 ●	Brass Anodized	White	Black

Black coaxial power supply cable. Time delivery: 25 Working Days
 Available from 30/09/2019
 Collection 2018 available until run out of stock.

Filo System - Pop C'est Toi

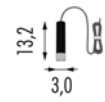

IP20	CE	CE	∇
500 mA	6W	CRI>90	
3CT1.2 S.□	12m Cable	€ 260,00	
3CT2.2 S.□	22m Cable	€ 350,00	
■ Led color	Nominal lm	Beam spread	
2 = 2700°K	528	20°	
3 = 3000°K	552		

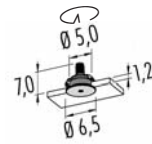

ARC Canopy ©	for max 1 diffuser	White painted
3FL5.ARC.06	IGBT - Triac	€ 105,00



CUP Canopy ©	for max 2 diffusers	Black painted
3FL5.CUP.02	IGBT - Triac	€ 200,00



CUP with Plug-in ©	for max 1 diffuser	Black painted
3FL5.PIN.02	On/off	€ 195,00

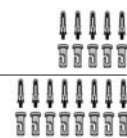

Wall - Ceiling Mounting		
1KIT.WM5.02	5 units Black	€ 16,00
1KIT.WM8.02	8 units Black	€ 25,00

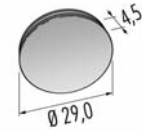

CUP Canopy ©	min. 3 max 12 diffusers	Black painted
3FL5.029.02	on/off	€ 360,00
3FL5.C29.02	0/1...10V	€ 450,00
3FL5.F29.02	DALI - Push	€ 450,00

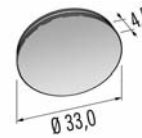

CUP Canopy ©	min. 6 max 24 diffusers	Black painted
3FL5.033.02	On/off	€ 550,00
3FL5.E33.02	DALI - Push - 0/1...10V	€ 650,00

Example 4 (8 art. C'est Toi) = Cup Ø cm. 29

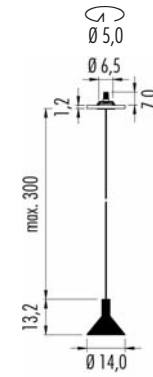

Pop Chérie *New*

IP20	ARC	CE
220-240V	6W CRI>90	dimnable IGBT - Triac
3CEA.2	S. □	€ 300,00
■ Led color	Nominal lm	Beam spread
2 = 2700°K	528	20°
3 = 3000°K	552	

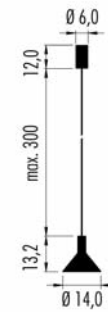

IP20	CUP	CE
220-240V	6W CRI>90	on/off
3CEC.2	S. □	€ 320,00
■ Led color	Nominal lm	Beam spread
2 = 2700°K	528	20°
3 = 3000°K	552	

□	Diffuser color	ARC canopy	CUP canopy
02	● Black	White	Black
06	○ White	White	Black
B	● Blue	White	Black
C	● Copper	White	Black
G	● Green	White	Black
P	● Rose	White	Black
R	● Red	White	Black

Black coaxial power supply cable. Time delivery: 25 Working Days
Available from 30/09/2019
Collection 2018 available until run out of stock.

Filo System - Pop Chérie *New*

IP40		CE
500 m/A	6W	CRI>90
3CE1.2	S. □	12m Cable € 300,00
3CE2.2	S. □	22m Cable € 390,00
■ Led color	Nominal lm	Beam spread
2 = 2700°K	528	20°
3 = 3000°K	552	

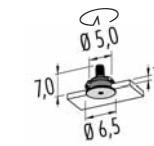

ARC Canopy	for max 1 diffuser	White painted
3FL5.ARC.06	IGBT - Triac	€ 105,00

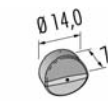

CUP Canopy	for max 2 diffusers	Black painted
3FL5.CUP.02	IGBT - Triac	€ 200,00



CUP with Plug-in	for max 1 diffuser	Black painted
3FL5.PIN.02	On/off	€ 195,00



Wall - Ceiling Mounting		
1KIT.WM5.02	5 units Black	€ 16,00
1KIT.WM8.02	8 units Black	€ 25,00

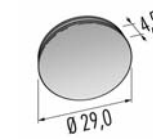

CUP Canopy	min. 3 max 12 diffusers	Black painted
3FL5.029.02	on/off	€ 360,00
3FL5.C29.02	0/1...10V	€ 450,00
3FL5.F29.02	DALI - Push	€ 450,00

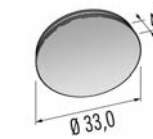

CUP Canopy	min. 6 max 24 diffusers	Black painted
3FL5.033.02	On/off	€ 550,00
3FL5.E33.02	DALI - Push - 0/1...10V	€ 650,00

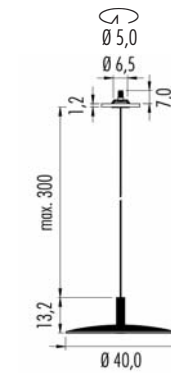
Pop Chapeau *New*

IP20	©	ARC	CE	▽
220-240V		6W CRI>90	dimmable IGBT - Triac	
3CHA.2	■ S. □		€ 340,00	
■ Led color		Nominal lm	Beam spread	
2 = 2700°K		528	20°	
3 = 3000°K		552		

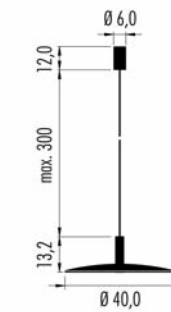

IP20	©	CUP	CE	▽
220-240V		6W CRI>90	on/off	
3CHC.2	■ S. □		€ 350,00	
■ Led color		Nominal lm	Beam spread	
2 = 2700°K		528	20°	
3 = 3000°K		552		

	Up	Down	ARC canopy	CUP canopy
02	●	●	Black/Black	White Black
06	○	○	White/White	White Black
C1K	●	●	Copper Anodized/Black	White Black
C1W	●	○	Copper Anodized/White	White Black
S1K	●	●	Brass Anodized/Black	White Black
S1W	●	○	Brass Anodized/White	White Black

Black coaxial power supply cable. Time delivery: 25 Working Days
 Available from 30/09/2019
 Collection 2018 available until run out of stock.

Filo System - Pop Chapeau *New*

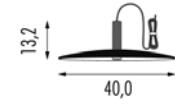

IP20	CE	CE	CE
500 mA	6W	CRI>90	
3CH1.2 S.□	12m Cable	€ 320,00	
3CH2.2 S.□	22m Cable	€ 400,00	
Led color	Nominal lm	Beam spread	
2 = 2700°K	528	20°	
3 = 3000°K	552		

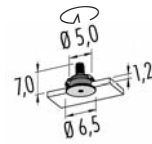

ARC Canopy	for max 1 diffuser	White painted
3FL5.ARC.06	IGBT - Triac	€ 105,00

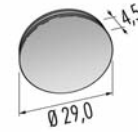

CUP Canopy	min. 3 max 12 diffusers	Black painted
3FL5.029.02	on/off	€ 360,00
3FL5.C29.02	0/1...10V	€ 450,00
3FL5.F29.02	DALI - Push	€ 450,00



CUP Canopy	for max 2 diffusers	Black painted
3FL5.CUP.02	IGBT - Triac	€ 200,00

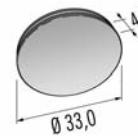

CUP Canopy	min. 6 max 24 diffusers	Black painted
3FL5.033.02	On/off	€ 550,00
3FL5.E33.02	DALI - Push - 0/1...10V	€ 650,00



CUP with Plug-in	for max 1 diffuser	Black painted
3FL5.PIN.02	On/off	€ 195,00

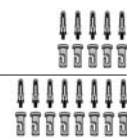

Wall - Ceiling Mounting		
1KIT.WM5.02	5 units Black	€ 16,00
1KIT.WM8.02	8 units Black	€ 25,00

Example 5 (6 art. Chapeau) = Cup Ø cm. 29



Pop BonBon

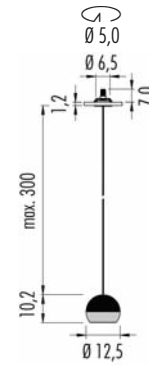

IP20 ©	ARC	CE ▽
220-240V	8W CRI>90	on/off
3BBA.2 ■ S.02		€ 380,00
3BBA.2 ■ S.06		€ 380,00
3BBA.2 ■ S.BC		€ 425,00
3BBA.2 ■ S.GC		€ 425,00
3BBA.2 ■ S.PC		€ 425,00
3BBA.2 ■ S.CR		€ 425,00
■ Led color	Nominal lm	Beam spread
2 = 2700 °K	893	22°
3 = 3000 °K	939	

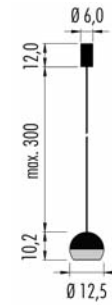

IP20 ©	CUP	CE ▽
220-240V	8W CRI>90	on/off
3BBC.2 ■ S.02		€ 380,00
3BBC.2 ■ S.06		€ 380,00
3BBC.2 ■ S.BC		€ 425,00
3BBC.2 ■ S.GC		€ 425,00
3BBC.2 ■ S.PC		€ 425,00
3BBC.2 ■ S.CR		€ 425,00
■ Led color	Nominal lm	Beam spread
2 = 2700 °K	893	22°
3 = 3000 °K	939	

□	Up	Down	ARC canopy	CUP canopy
02	●	●	White	Black
06	○	○	White	Black
BC	●	●	White	Black
GC	●	●	White	Black
PC	●	●	White	Black
CR	●	●	White	Black

Black coaxial power supply cable. Time delivery: 25 Working Days

Filo System - Pop BonBon



IP20 ©	250 m/A	8W	CE ▽
			CRI>90
3BB1.2 ■ S.02	12m Cable		€ 350,00
3BB1.2 ■ S.06	12m Cable		€ 350,00
3BB1.2 ■ S.BC	12m Cable		€ 396,00
3BB1.2 ■ S.GC	12m Cable		€ 396,00
3BB1.2 ■ S.PC	12m Cable		€ 396,00
3BB1.2 ■ S.CR	12m Cable		€ 396,00
3BB2.2 ■ S.02	22m Cable		€ 436,00
3BB2.2 ■ S.06	22m Cable		€ 436,00
3BB2.2 ■ S.BC	22m Cable		€ 486,00
3BB2.2 ■ S.GC	22m Cable		€ 486,00
3BB2.2 ■ S.PC	22m Cable		€ 486,00
3BB2.2 ■ S.CR	22m Cable		€ 486,00
■ Led color	Nominal lm	Beam spread	
2 = 2700 °K	893	22°	
3 = 3000 °K	939		

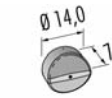
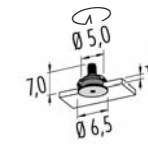

ARC Canopy ©	for max 1 diffuser	White painted
3FL2.ARC.06	On/off	€ 105,00

CUP Canopy ©	for max 2 diffusers	Black painted
3FL2.CUP.02	On/off	€ 200,00

CUP Canopy ©	for max 1 diffuser	Black painted
3FL2.PIN.02	On/off	€ 195,00

Wall - Ceiling Mounting

1KIT.WM5.02	5 units	Black	€ 16,00
-------------	---------	-------	---------

1KIT.WM8.02	8 units	Black	€ 25,00
-------------	---------	-------	---------



CUP Canopy ©	min. 3 max 3 diffusers	Black painted
3FL2.029.02	On/off	€ 380,00
3FL2.F29.02	DALI - Push	€ 450,00

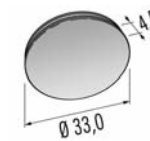

CUP Canopy ©	min. 6 max 6 diffusers	Black painted
3FL2.033.02	On/off	€ 550,00

CUP Canopy ©	min. 3 max 9 diffusers	Black painted
3FL2.E33.02	DALI - Push - 0/1...10V	€ 650,00

Pop Petit

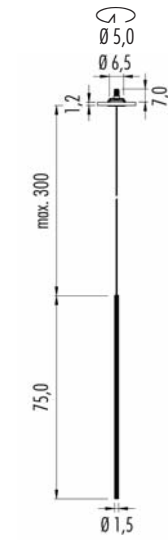

IP54	ARC	CE
220-240V	2,3W CRI>90	on/off
3PTA.2	L.	€ 330,00
Led color	Nominal lm	Beam spread
2 = 2700°K	237	60°
3 = 3000°K	256	

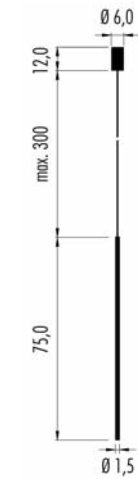

IP20	CUP	CE
220-240V	2,3W CRI>90	on/off
3PTC.2	L.	€ 330,00
Led color	Nominal lm	Beam spread
2 = 2700°K	237	60°
3 = 3000°K	256	

	Diffuser color	ARC canopy	CUP canopy
02	Black	White	Black
06	White	White	Black
B	Blue	White	Black
C	Copper	White	Black
G	Green	White	Black
P	Rose	White	Black
R	Red	White	Black

Black coaxial power supply cable. Time delivery: 25 Working Days

Filo System - Pop Petit

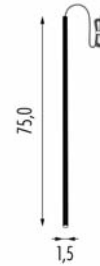

IP40	CE	CE	∇
700 mA	2,3W	CRI>90	
3PT1.2 L. □	12m Cable	€ 300,00	
3PT2.2 L. □	22m Cable	€ 380,00	
Led color	Nominal lm	Beam spread	
2 = 2700°K	528	60°	
3 = 3000°K	552		

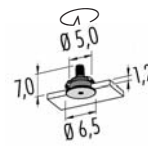

ARC Canopy	for max 1 diffuser	White painted
3FL7.ARC.06	On/off	€ 105,00

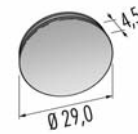

CUP Canopy	min. 3 max 12 diffusers	Black painted
3FL7.029.02	on/off	€ 360,00
3FL7.F29.02	DALI - Push	€ 450,00



CUP Canopy	for max 2 diffusers	Black painted
3FL7.CUP.02	IGBT - Triac	€ 200,00

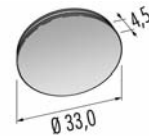

CUP Canopy	min. 6 max 24 diffusers	Black painted
3FL7.033.02	On/off	€ 550,00

CUP Canopy	min. 3 max 24 diffusers	Black painted
3FL7.E33.02	DALI - Push - 0/1...10V	€ 650,00



CUP with Plug-in	for max 1 diffuser	Black painted
3FL7.PIN.02	On/off	€ 195,00

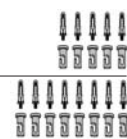

Wall - Ceiling Mounting		
1KIT.WM5.02	5 units Black	€ 16,00
1KIT.WM8.02	8 units Black	€ 25,00

Example 6 (24 art. Petit)= Cup Ø cm. 33



Pop 00 Ø 3,0 trimless (for plasterboard and brickwork)

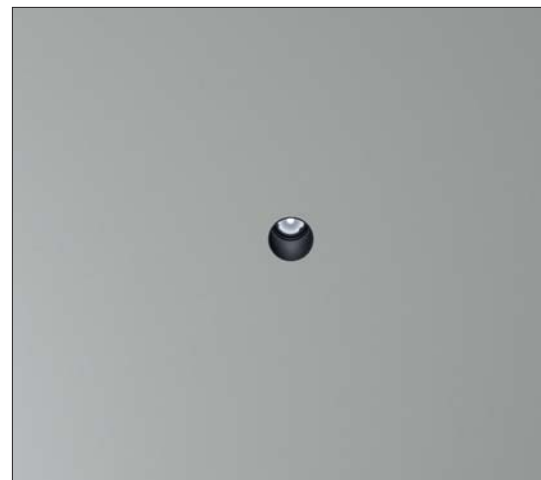
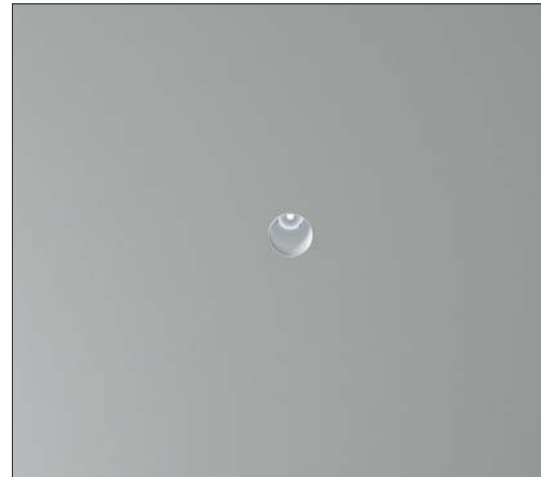

- Frame
- 02 ● Black
06 ○ White
C1 ● Copper Anodized
S1 ● Brass Anodized

Finishes C1 and S1 are available from 30/09/2019

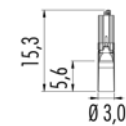

IP40 ☉	MC-E=3	CE	▽	⊕
500m/A	LED 6W	CRI>90		
3P00.3 ■ M. □		€ 125,00		

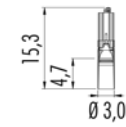

IP54 ☉	MC-E=3	CE	▽	⊕
500m/A	LED 6W	CRI>90		
3P00.3 ■ M9. □		€ 135,00		

■ Led color	Nominal lm	▲ Beam spread
2 = 2700°K	528	17°
3 = 3000°K	552	

☉ (m-M) Driver ONLY in remote installation

3KIT.500.15 (1-1)	on/off	€ 27,00
3KIT.501.50 (1-7)	DALI - Push - 1...10V	€ 105,00
3KIT.502.20 (1-3)	DALI	€ 59,00
3KIT.503.20 (1-3)	Push - 1...10	€ 59,00
3KIT.504.10 (1-1)	IGBT - TRIAC	€ 32,00

Housing for plasterboard

- **1Z00.030.01** ⤴ ⤵ Ø 4,0cm € 20,00

Housing for brickwork

- **1M00.030.01** € 54,00

(m-M) = min. Led unit - Max Led unit.
Led and Emergency unit, warranty only when used together with driver bought from Oty srl.

Pop 00 NaNo Ø 3,0 trimless (only for plasterboard)



- Frame
- 02 ● Black
06 ○ White
C1 ● Copper Anodized
S1 ● Brass Anodized

Available from 30/09/2019

(m-M) = min. Led unit - Max Led unit.
Led and Emergency unit, warranty only when used together with driver bought from Oty srl.

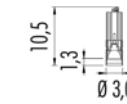

IP40 ☉	MC-E=3	CE	▽	⊕
500m/A	LED 6W	CRI>90		
3N00.3 ■ M. □		€ 80,00		

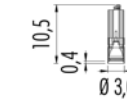

IP54 ☉	MC-E=3	CE	▽	⊕
500m/A	LED 6W	CRI>90		
3N00.3 ■ M9. □		€ 90,00		

■ Led color	Nominal lm	▲ Beam spread
2 = 2700°K	528	25°
3 = 3000°K	552	

☉ (m-M) Driver ONLY in remote installation

3KIT.500.15 (1-1)	on/off	€ 27,00
3KIT.501.50 (1-7)	DALI - Push - 1...10V	€ 105,00
3KIT.502.20 (1-3)	DALI	€ 59,00
3KIT.503.20 (1-3)	Push - 1...10	€ 59,00
3KIT.504.10 (1-1)	IGBT - TRIAC	€ 32,00

Pop N00 NaNo: housing for plasterboard

- **1N00.030.01** ⤴ ⤵ Ø 4,0cm € 20,00

easy Pop 00 Ø 3,0 with trim (for plasterboard and brickwork)

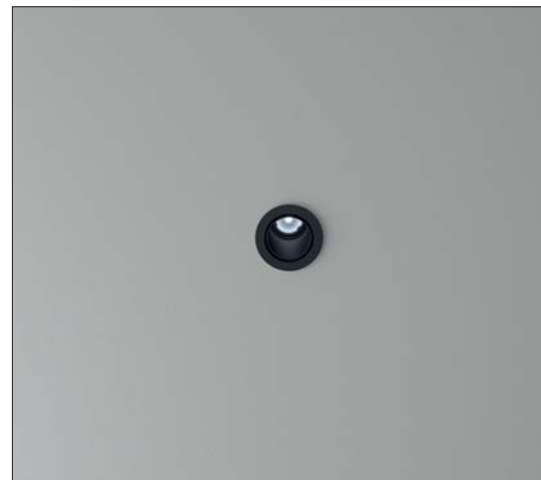

- Frame
- 02 ● Black
 - 06 ○ White
 - C1 ● Copper Anodized
 - S1 ● Brass Anodized

Available from 30/09/2019

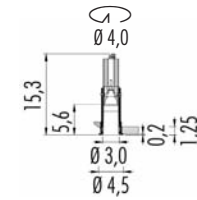

IP40 ☉	MC-E=3	CE	▽	⚡
500m/A	LED 6W	CRI>90		
3E00.3 ■ M. □		€ 120,00		

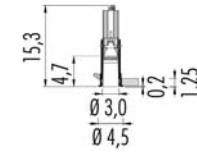

IP54 ☉	MC-E=3	CE	▽	⚡
500m/A	LED 6W	CRI>90		
3E00.3 ■ M9. □		€ 130,00		

■ Led color	Nominal lm	▲ Beam spread
2 = 2700 °K	528	17°
3 = 3000 °K	552	

☉ (m-M) Driver ONLY in remote installation

3KIT.500.15 (1-1)	on/off	€ 27,00
3KIT.501.50 (1-7)	DALI - Push - 1...10V	€ 105,00
3KIT.502.20 (1-3)	DALI	€ 59,00
3KIT.503.20 (1-3)	Push - 1...10	€ 59,00
3KIT.504.10 (1-1)	IGBT - TRIAC	€ 32,00

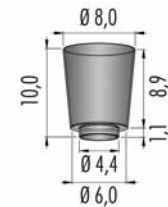

Housing for brickwork

- **1E00.030.01** € 19,00

(m-M) = min. Led unit - Max Led unit.
Led and Emergency unit, warranty only when used
together with driver bought from Oty srl.

easy Pop 00 NaNo Ø 3,0 with trim (for plasterboard and brickwork)

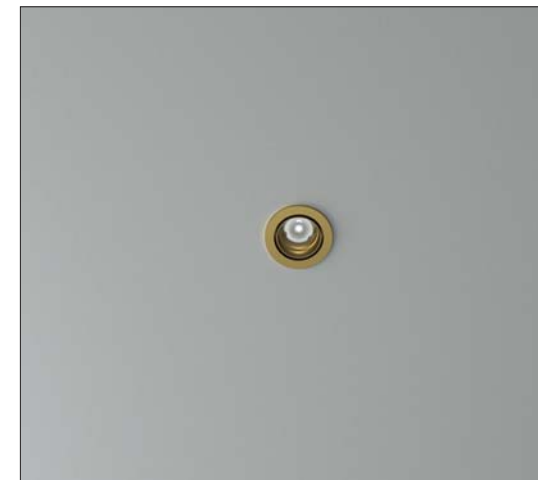

- Frame
- 02 ● Black
 - 06 ○ White
 - C1 ● Copper Anodized
 - S1 ● Brass Anodized

Available from 30/09/2019

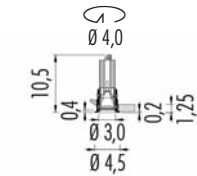

IP40 ☉	MC-E=3	CE	▽	⚡
500m/A	LED 6W	CRI>90		
3F00.3 ■ M. □		€ 95,00		

IP54 ☉	MC-E=3	CE	▽	⚡
500m/A	LED 6W	CRI>90		
3F00.3 ■ M9. □		€ 105,00		

■ Led color	Nominal lm	▲ Beam spread
2 = 2700 °K	528	25°
3 = 3000 °K	552	

☉ (m-M) Driver ONLY in remote installation

3KIT.500.15 (1-1)	on/off	€ 27,00
3KIT.501.50 (1-7)	DALI - Push - 1...10V	€ 105,00
3KIT.502.20 (1-3)	DALI	€ 59,00
3KIT.503.20 (1-3)	Push - 1...10	€ 59,00
3KIT.504.10 (1-1)	IGBT - TRIAC	€ 32,00

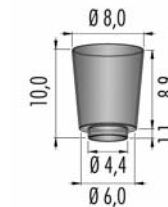

Housing for brickwork

- **1E00.030.01** € 19,00

(m-M) = min. Led unit - Max Led unit.
Led and Emergency unit, warranty only when used
together with driver bought from Oty srl.

Pop 01 Ø 4,0 trimless (only for plasterboard)

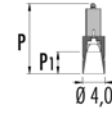
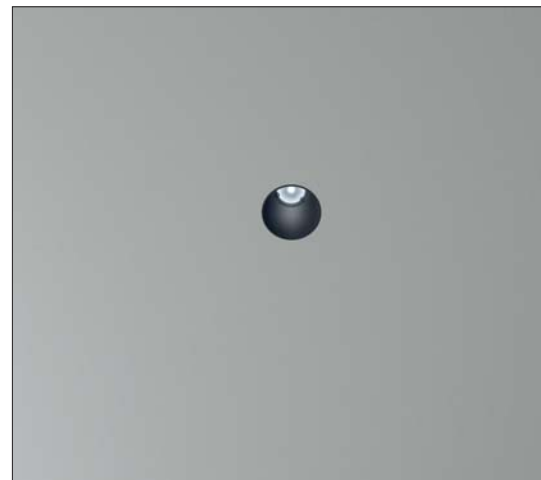

IP40	CE	∇	⊕
12V			
3P01.200.□	GU4 max 35W	€ 35,00	
3KIT.201.050	max 50VA	€ 32,00	
Dimmable gear: IGBT			
IP40	MC-E=3	CE	∇
500m/A	LED 6W	CRI>90	
3P01.2■S.□		€ 102,00	
IP54	MC-E=3	CE	∇
500m/A	LED 6W	CRI>90	
3P01.2■S9.□		€ 135,00	
■ Led color	Nominal lm	▲ Beam spread	
2 = 2700°K	528	22°	
3 = 3000°K	552		

□ (m-M)	Driver	
3KIT.500.15 (1-1)	on/off	€ 27,00
3KIT.501.50 (1-7)	DALI - Push - 1...10V Remote installation	€ 105,00
3KIT.502.20 (1-3)	DALI Remote installation	€ 59,00
3KIT.503.20 (1-3)	Push - 1...10 Remote installation	€ 59,00
3KIT.504.10 (1-1)	IGBT - TRIAC Remote installation	€ 32,00

Housing for plasterboard

- 1Z00.040.01 ⌀ 5,1cm € 17,00

□	Frame
02	Black
06	White
C1	Copper Anodized
S1	Brass Anodized

Finishes C1 and S1 are available from 30/09/2019

Pop P01	P	P1
3P01.200.□ led IP40	9,1	3,9
3P01.2■S.□ led IP40	13,2	3,9
3P01.2■S9.□ led IP54	14,0	3,9

(m-M) = min. Led unit - Max Led unit.
Led and Emergency unit, warranty only when used together with driver bought from Oty srl.

easy Pop 01 Ø 4,0 with trim (for plasterboard and brickwork)

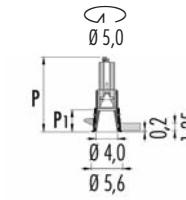

IP40	CE	∇	⊕
12V			
3E01.200.□	GU4 max 35W	€ 50,00	
3KIT.201.050	max 50VA	€ 32,00	
Dimmable gear: IGBT			
IP40	MC-E=3	CE	∇
500m/A	LED 6W	CRI>90	
3E01.2■S.□		€ 100,00	
IP54	MC-E=3	CE	∇
500m/A	LED 6W	CRI>90	
3E01.2■S9.□		€ 130,00	
■ Led color	Nominal lm	▲ Beam spread	
2 = 2700°K	528	22°	
3 = 3000°K	552		

□ (m-M)	Driver	
3KIT.500.15 (1-1)	on/off	€ 27,00
3KIT.501.50 (1-7)	DALI - Push - 1...10V Remote installation	€ 105,00
3KIT.502.20 (1-3)	DALI Remote installation	€ 59,00
3KIT.503.20 (1-3)	Push - 1...10 Remote installation	€ 59,00
3KIT.504.10 (1-1)	IGBT - TRIAC Remote installation	€ 32,00

□	Frame
02	Black
06	White
C1	Copper Anodized
S1	Brass Anodized

Available from 30/09/2019

Pop E01	P	P1
3E01.200.□ led IP40	9,1	3,9
3E01.2■S.□ led IP40	13,2	3,9
3E01.2■S9.□ led IP54	14,0	3,9

(m-M) = min. Led unit - Max Led unit.
Led and Emergency unit, warranty only when used together with driver bought from Oty srl.

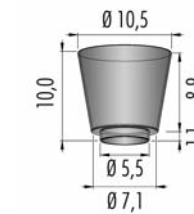

Housing for brickwork

- 1E00.040.01 € 20,00

Pop 01 Ø 5,5 trimless (for plasterboard and brickwork)

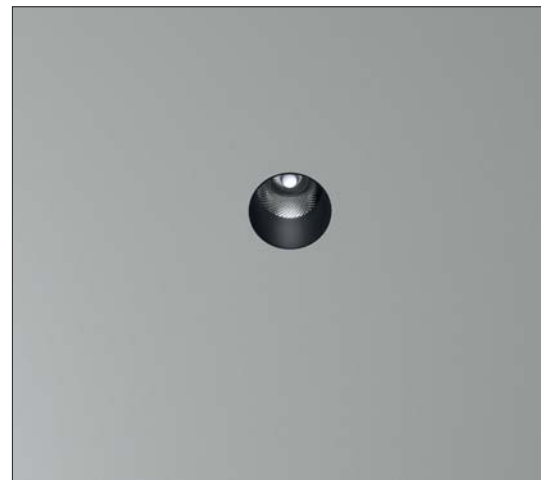

Frame	Color
02	Black
06	White
C1	Copper Anodized
S1	Brass Anodized

Finishes C1 and S1 are available from 30/09/2019

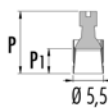

Pop 01	P	P1
3P01.210.□ GU10	13,2	4,4
3P01.211.□ GU10 led	—	4,4
4P01.211.□ GU10 led + honeycomb	—	4,4
3P01.220.□ GU5.3	11,6	4,4
4P01.220.□ GU5.3 led + honeycomb	—	4,4
3P01.2209.□ GU5.3 IP44	13,0	3,4
4P01.2209.□ GU5.3 IP44 led + honeycomb	—	3,4
3P01.K■S.□ led 9,5W IP40	13,8	4,4
4P01.K■S.□ led 9,5W IP40 + honeycomb	14,3	4,4

IP20	CE	Energy	RoHS
220V ÷ 240V			
3P01.210.□ GU10 max 50W	€	46,50	
3P01.211.□ GU10 led	€	46,50	
4P01.211.□ GU10 led	€	52,50	
With honeycomb			

IP20	CE	Energy	RoHS
12V			
3P01.220.□ GU5.3 max 50W	€	36,00	
4P01.220.□ GU5.3 led	€	42,00	
With honeycomb			
3KIT.201.050 max 50VA	€	32,00	
Dimmable gear: IGBT			

IP44	CE	Energy	RoHS
12V			
3P01.2209.□ GU5.3 max 35W	€	67,00	
4P01.2209.□ GU5.3 led	€	73,00	
With honeycomb			
3KIT.201.050 max 50VA	€	32,00	
Dimmable gear: IGBT			

IP40	Flicker < 20%	CE	Energy	RoHS
220V ÷ 240V	LED 9,5W		CRI>90	
3P01.K■S.□ dimm IGBT - TRIAC	€	69,00		
4P01.K■S.□ dimm IGBT - TRIAC	€	75,00		
With honeycomb				
■ Led color	Nominal lm	▲ Beam spread		
2 = 2700°K	710	24°		
3 = 3000°K	760			

Housing for plasterboard	Ø 6,5cm		
● 1Z00.055.01	Single	€	18,00
●● 1Z00.055.2L	Double	€	33,00
●●● 1Z00.055.3L	Triple	€	49,00
Housing for brickwork			
● 1M00.055.01		€	90,00



IP40	DimToWarm	CE	Energy	RoHS
220V ÷ 240V	LED 6W CRI 95		Driver included	
3P01.3W▲.□ dimm IGBT - TRIAC	€	140,00		
4P01.3W▲.□ dimm IGBT - TRIAC	€	146,00		
With honeycomb				

IP54	DimToWarm	CE	Energy	RoHS
220V ÷ 240V	LED 6W CRI 95		Driver included	
3P01.3W▲9.□ dimm IGBT - TRIAC	€	155,00		
4P01.3W▲9.□ dimm IGBT - TRIAC	€	161,00		
With honeycomb				

■ Led color	Nominal lm	▲ Beam spread
W = max 3000°K	max 445 lm	M = 30°
min. 1800°K	min. 10 lm	S = 18°

IP40	MC-E=3	CE	Energy	RoHS
350m/A	LED 11W		CRI>90	
3P01.3■▲.□	€	120,00		
4P01.3■▲.□	€	126,00		
With honeycomb				

IP54	MC-E=3	CE	Energy	RoHS
350m/A	LED 11W		CRI>90	
3P01.3■▲9.□	€	135,00		
4P01.3■▲9.□	€	141,00		
With honeycomb				

■ Led color	Nominal lm	▲ Beam spread
2 = 2700°K	1195	S = 22°
3 = 3000°K	1257	T = 12°
4 = 4000°K	1313	

Frame	Color
02	Black
06	White
C1	Copper Anodized
S1	Brass Anodized

Finishes C1 and S1 are available from 30/09/2019

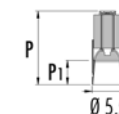

Pop 01	P	P1
3P01.3■▲.□ led IP40	13,8	4,4
4P01.3■▲.□ led IP40 + honeycomb	14,3	4,4
3P01.3■▲9.□ led IP54	15,2	3,4
4P01.3■▲9.□ led IP54 + honeycomb	15,7	3,4
3P01.3W▲.□ led IP40	10,7	4,4
4P01.3W▲.□ led IP40 + honeycomb	11,2	4,4
3P01.3W▲9.□ led IP54	11,3	3,4
4P01.3W▲9.□ led IP54 + honeycomb	11,8	3,4

(m-M) = min. Led unit - Max Led unit.
Led and Emergency unit, warranty only when used together with driver bought from Oty srl.

© (m-M)	Driver	
3KIT.350.1L (1-1)	on/off	€ 21,00
3KIT.351.40 (1-3)	DALI - Push - 1...10V Remote installation	€ 105,00
3KIT.352.15 (1-1)	DALI	€ 59,00
3KIT.353.15 (1-1)	Push - 1...10V	€ 59,00
3KIT.354.18 (1-1)	IGBT - TRIAC	€ 32,00
Emergency unit: (inverter + battery. Driver not included)		
3KIT.900.01 (1-1)	1:00 hour	€ 95,00
3KIT.900.03 (1-1)	3:00 hours	€ 137,00

Housing for plasterboard	Ø 6,5cm		
● 1Z00.055.01	Single	€	18,00
●● 1Z00.055.2L	Double	€	33,00
●●● 1Z00.055.3L	Triple	€	49,00
Housing for brickwork			
● 1M00.055.01		€	90,00

Pop 01 NaNo Ø 5,5 (for plasterboard and brickwork)



Frame	Color
02	Black
06	White
C1	Copper Anodized
S1	Brass Anodized

Available from 30/09/2019

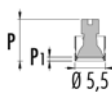

Pop 01	P	P1
3N01.210.□ GU10	9,5	0,7
3N01.211.□ GU10 led	—	0,7
4N01.211.□ GU10 led + honeycomb	—	0,7
3N01.220.□ GU5.3	7,9	0,7
4N01.220.□ GU5.3 led + honeycomb	—	0,7
3N01.2209.□ GU5.3 IP44	8,8	0,7
4N01.2209.□ GU5.3 IP44 led + honeycomb	—	0,7
3N01.K■S.□ led 9,5W IP40	10,5	0,7
4N01.K■S.□ led 9,5W IP40 + honeycomb	11,0	0,7

IP20	CE	Energy	RoHS
220V ÷ 240V			
3N01.210.□ GU10 max 50W	€	44,00	
3N01.211.□ GU10 led	€	44,00	
4N01.211.□ GU10 led	€	50,00	
With honeycomb			

IP20	CE	Energy	RoHS
12V			
3N01.220.□ GU5.3 max 50W	€	36,00	
4N01.220.□ GU5.3 led	€	42,00	
With honeycomb			
3KIT.201.050 max 50VA	€	32,00	
Dimmable gear: IGBT			

IP44	CE	Energy	RoHS
12V			
3N01.2209.□ GU5.3 max 35W	€	58,00	
4N01.2209.□ GU5.3 led	€	64,00	
With honeycomb			
3KIT.201.050 max 50VA	€	32,00	
Dimmable gear: IGBT			

IP40	Flicker < 20%	CE	Energy	RoHS
220V ÷ 240V	LED 9,5W		CRI>90	
3N01.K■S.□ dimm IGBT - TRIAC	€	69,00		
4N01.K■S.□ dimm IGBT - TRIAC	€	75,00		
With honeycomb				
■ Led color	Nominal lm	▲ Beam spread		
2 = 2700°K	710	24°		
3 = 3000°K	760			

Housing for plasterboard	Ø 6,5cm		
● 1Z00.055.01	Single	€	18,00
●● 1Z00.055.2L	Double	€	33,00
●●● 1Z00.055.3L	Triple	€	49,00
Housing for brickwork			
● 1M00.055.01		€	90,00



IP40	DimToWarm	CE	Energy	RoHS
220V ÷ 240V	LED 6W CRI 95		Driver included	
3N01.3W▲.□ dimm IGBT - TRIAC	€	120,00		
4N01.3W▲.□ dimm IGBT - TRIAC	€	126,00		
With honeycomb				

IP54	DimToWarm	CE	Energy	RoHS
220V ÷ 240V	LED 6W CRI 95		Driver included	
3N01.3W▲9.□ dimm IGBT - TRIAC	€	145,00		
4N01.3W▲9.□ dimm IGBT - TRIAC	€	151,00		
With honeycomb				

■ Led color	Nominal lm	▲ Beam spread
W = max 3000°K	max 445 lm	M = 30°
min. 1800°K	min. 10 lm	S = 18°

IP40	MC-E=3	CE	Energy	RoHS
250m/A	LED 8W		CRI>90	
3N01.3■▲.□	€	100,00		
4N01.3■▲.□	€	106,00		
With honeycomb				

IP54	MC-E=3	CE	Energy	RoHS
250m/A	LED 8W		CRI>90	
3N01.3■▲9.□	€	115,00		
4N01.3■▲9.□	€	121,00		
With honeycomb				

■ Led color	Nominal lm	▲ Beam spread
2 = 2700°K	779	M = 38°
3 = 3000°K	819	S = 22°
4 = 4000°K	855	T = 12°

Frame	Color
02	Black
06	White
C1	Copper Anodized
S1	Brass Anodized

Available from 30/09/2019

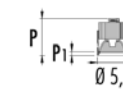

Pop 01	P	P1
3N01.3■▲.□ led IP40	7,1	0,7
4N01.3■▲.□ led IP40 + honeycomb	7,6	0,7
3N01.3■▲9.□ led IP54	8,0	0,7
4N01.3■▲9.□ led IP54 + honeycomb	8,5	0,7
3N01.3W▲.□ led IP40	6,9	0,7
4N01.3W▲.□ led IP40 + honeycomb	7,4	0,7
3N01.3W▲9.□ led IP54	7,8	0,7
4N01.3W▲9.□ led IP54 + honeycomb	8,3	0,7

© (m-M)	Driver	
3KIT.250.1L (1-1)	on/off	€ 21,00
3KIT.251.28 (1-3)	DALI - Push - 1...10V Remote installation	€ 105,00
3KIT.252.12 (1-1)	DALI	€ 59,00
3KIT.253.13 (1-1)	Push - 1...10V	€ 59,00
3KIT.254.12 (1-1)	IGBT - TRIAC	€ 32,00

Emergency unit: (inverter + battery. Driver not included)

3KIT.900.01 (1-1)	1:00 hour	€ 95,00
3KIT.900.03 (1-1)	3:00 hours	€ 137,00

Housing for plasterboard	Ø 6,5cm		
● 1Z00.055.01	Single	€	18,00
●● 1Z00.055.2L	Double	€	33,00
●●● 1Z00.055.3L	Triple	€	49,00
Housing for brickwork			
● 1M00.055.01		€	90,00

(m-M) = min. Led unit - Max Led unit.
Led and Emergency unit, warranty only when used together with driver bought from Oty srl.

easy Pop 01 ø 5,5 with trim (for plasterboard and brickwork)



Frame	Color
02	Black
06	White
C1	Copper Anodized
S1	Brass Anodized

Available from 30/09/2019

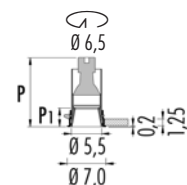

Pop E01	P	P1
3E01.210.□	GU10	13,2 4,4
3E01.211.□	GU10 led	— 4,4
4E01.211.□	GU10 led + honeycomb	— 4,4
3E01.220.□	GU5.3	11,6 4,4
4E01.220.□	GU5.3 led + honeycomb	— 4,4
3E01.2209.□	GU5.3 IP44	13,0 3,4
4E01.2209.□	GU5.3 IP44 led + honeycomb	— 3,4
3E01.K■S.□	led 9,5W IP40	13,8 4,4
4E01.K■S.□	led 9,5W IP40 + honeycomb	14,3 4,4

IP20

220V ÷ 240V			
3E01.210.□	GU10 max 50W	€	60,00
3E01.211.□	GU10 led	€	60,00
4E01.211.□	GU10 led	€	66,00
With honeycomb			

IP20

12V			
3E01.220.□	GU5.3 max 50W	€	52,00
4E01.220.□	GU5.3 led	€	58,00
With honeycomb			
3KIT.201.050	max 50VA	€	32,00
Dimmable gear: IGBT			

IP44

12V			
3E01.2209.□	GU5.3 max 35W	€	75,00
4E01.2209.□	GU5.3 led	€	83,00
With honeycomb			
3KIT.201.050	max 50VA	€	32,00
Dimmable gear: IGBT			

IP40

220V ÷ 240V	LED 9,5W	CRI>90	
3E01.K■S.□	dim IGBT - TRIAC	€	82,00
4E01.K■S.□	dim IGBT - TRIAC	€	88,00
With honeycomb			

Led color	Nominal lm	Beam spread
2 = 2700°K	710	24°
3 = 3000°K	760	

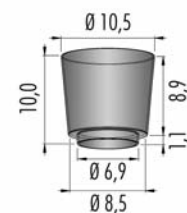

Housing for brickwork

● 1E00.055.01	€	20,00
---------------	---	-------



IP40

220V ÷ 240V	LED 6W	CRI 95	Driver included
3E01.3W■□	dim IGBT - TRIAC	€	145,00
4E01.3W■□	dim IGBT - TRIAC	€	151,00
With honeycomb			

IP54

220V ÷ 240V	LED 6W	CRI 95	Driver included
3E01.3W■9.□	dim IGBT - TRIAC	€	161,00
4E01.3W■9.□	dim IGBT - TRIAC	€	167,00
With honeycomb			

Led color	Nominal lm	Beam spread
W = max 3000°K	max 445 lm	M = 30°
min. 1800°K	min. 10 lm	S = 18°

IP40

350m/A	LED 11W	CRI>90	
3E01.3■9.□		€	90,00
4E01.3■9.□		€	96,00
With honeycomb			

IP54

350m/A	LED 11W	CRI>90	
3E01.3■9.□		€	105,00
4E01.3■9.□		€	111,00
With honeycomb			

Led color	Nominal lm	Beam spread
2 = 2700°K	1195	S = 22°
3 = 3000°K	1257	T = 12°
4 = 4000°K	1313	

Frame	Color
02	Black
06	White
C1	Copper Anodized
S1	Brass Anodized

Available from 30/09/2019

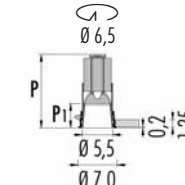

Pop E01	P	P1
3E01.3■9.□	led IP40	13,8 4,4
4E01.3■9.□	led IP40 + honeycomb	14,3 4,4
3E01.3■9.□	led IP54	15,2 3,4
4E01.3■9.□	led IP54 + honeycomb	15,7 3,4
3E01.3W■□	led IP40	10,7 4,4
4E01.3W■□	led IP40 + honeycomb	11,2 4,4
3E01.3W■9.□	led IP54	11,3 3,4
4E01.3W■9.□	led IP54 + honeycomb	11,8 3,4

(m-M) = min. Led unit - Max Led unit.
Led and Emergency unit, warranty only when used together with driver bought from Oty srl.

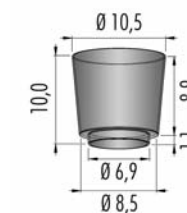

Housing for brickwork

● 1E00.055.01	€	20,00
---------------	---	-------

Driver	Emergency unit: (inverter + battery, Driver not included)
3KIT.350.1L (1-1) on/off	€ 21,00
3KIT.351.40 (1-3) DALI - Push - 1...10V Remote installation	€ 105,00
3KIT.352.15 (1-1) DALI	€ 59,00
3KIT.353.15 (1-1) Push - 1...10V	€ 59,00
3KIT.354.18 (1-1) IGBT - TRIAC	€ 32,00
3KIT.900.01 (1-1) 1:00 hour	€ 95,00
3KIT.900.03 (1-1) 3:00 hours	€ 137,00

easy Pop 01 NaNo Ø 5,5 with trim (for plasterboard and brickwork)



Frame	Color
02	Black
06	White
C1	Copper Anodized
S1	Brass Anodized

Available from 30/09/2019

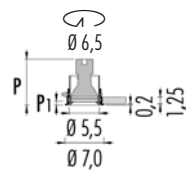

Pop F01	P	P1
3F01.210.□ GU10	9,5	0,7
3F01.211.□ GU10 led	—	0,7
4F01.211.□ GU10 led + honeycomb	—	0,7
3F01.220.□ GU5.3	7,9	0,7
4F01.220.□ GU5.3 led + honeycomb	—	0,7
3F01.2209.□ GU5.3 IP44	8,8	0,7
4F01.2209.□ GU5.3 IP44 led + honeycomb	—	0,7
3F01.K■S.□ led 9,5W IP40	10,5	0,7
4F01.K■S.□ led 9,5W IP40 + honeycomb	11,0	0,7

IP20	CE	V	□
220V ÷ 240V			
3F01.210.□ GU10 max 50W	€	60,00	
3F01.211.□ GU10 led	€	60,00	
4F01.211.□ GU10 led	€	66,00	
With honeycomb			

IP20	CE	V	⊕
12V			
3F01.220.□ GU5.3 max 50W	€	52,00	
4F01.220.□ GU5.3 led	€	58,00	
With honeycomb			
3KIT.201.050 max 50VA	€	32,00	
Dimmable gear: IGBT			

IP44	CE	V	⊕
12V			
3F01.2209.□ GU5.3 max 35W	€	75,00	
4F01.2209.□ GU5.3 led	€	83,00	
With honeycomb			
3KIT.201.050 max 50VA	€	32,00	
Dimmable gear: IGBT			

IP40	Flicker < 20%	CE	V	□
220V ÷ 240V	LED 9,5W			CRI>90
3F01.K■S.□ dimm IGBT - TRIAC	€	82,00		
4F01.K■S.□ dimm IGBT - TRIAC	€	88,00		
With honeycomb				

Led color	Nominal lm	Beam spread
2 = 2700°K	710	24°
3 = 3000°K	760	

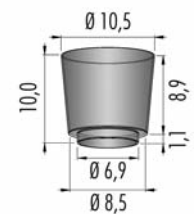

Housing for brickwork

● 1E00.055.01	€	20,00
---------------	---	-------



IP40	DimToWarm	CE	V	⊕
220V ÷ 240V	LED 6W CRI 95			Driver included
3F01.3W■□ dimm IGBT - TRIAC	€	140,00		
4F01.3W■□ dimm IGBT - TRIAC	€	146,00		
With honeycomb				

IP54	DimToWarm	CE	V	⊕
220V ÷ 240V	LED 6W CRI 95			Driver included
3F01.3W■9.□ dimm IGBT - TRIAC	€	161,00		
4F01.3W■9.□ dimm IGBT - TRIAC	€	167,00		
With honeycomb				

Led color	Nominal lm	Beam spread
W = max 3000°K	max 445 lm	M = 30°
min. 1800°K	min. 10 lm	S = 18°

IP40	MC-E=3	CE	V	⊕
250m/A	LED 8W			CRI>90
3F01.3■□	€	85,00		
4F01.3■□	€	91,00		
With honeycomb				

IP54	MC-E=3	CE	V	⊕
250m/A	LED 8W			CRI>90
3F01.3■9.□	€	105,00		
4F01.3■9.□	€	111,00		
With honeycomb				

Led color	Nominal lm	Beam spread
2 = 2700°K	779	M = 38°
3 = 3000°K	819	S = 22°
4 = 4000°K	855	T = 12°

Frame	Color
02	Black
06	White
C1	Copper Anodized
S1	Brass Anodized

Available from 30/09/2019

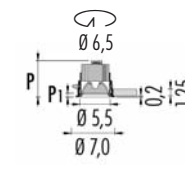

Pop F01	P	P1
3F01.3■□ led IP40	7,1	0,7
4F01.3■□ led IP40 + honeycomb	7,6	0,7
3F01.3■9.□ led IP54	8,0	0,7
4F01.3■9.□ led IP54 + honeycomb	8,5	0,7
3F01.3W■□ led IP40	6,9	0,7
4F01.3W■□ led IP40 + honeycomb	7,4	0,7
3F01.3W■9.□ led IP54	7,8	0,7
4F01.3W■9.□ led IP54 + honeycomb	8,3	0,7

(m-M) = min. Led unit - Max Led unit.
Led and Emergency unit, warranty only when used together with driver bought from Oty srl.

© (m-M)	Driver	
3KIT.250.1L (1-1)	on/off	€ 21,00
3KIT.251.28 (1-3)	DALI - Push - 1...10V Remote installation	€ 105,00
3KIT.252.12 (1-1)	DALI	€ 59,00
3KIT.253.13 (1-1)	Push - 1...10V	€ 59,00
3KIT.254.12 (1-1)	IGBT - TRIAC	€ 32,00
Emergency unit: (inverter + battery, Driver not included)		
3KIT.900.01 (1-1)	1:00 hour	€ 95,00
3KIT.900.03 (1-1)	3:00 hours	€ 137,00

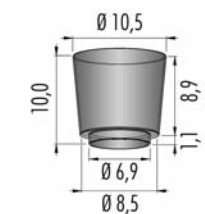

Housing for brickwork

● 1E00.055.01	€	20,00
---------------	---	-------

Pop 01 small Bulb trimless (for plasterboard and brickwork)

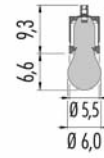

IP20	ⓘ	CE	▽	□
220V ÷ 240V	e27 led 4W	CRI>80		
3P01.A2L.□	dimmi IGBT - TRIAC	€ 73,00		
■ Led color	Nominal lm	▲ Beam spread		
2700 °K	470	360°		

Pop 01 big Bulb trimless (for plasterboard and brickwork)

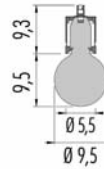

IP20	ⓘ	CE	▽	□
220V ÷ 240V	e27 led 4W	CRI>80		
3P01.B2L.□	dimmi IGBT - TRIAC	€ 78,00		
■ Led color	Nominal lm	▲ Beam spread		
2700 °K	470	360°		

□	Frame
02 ●	Black
06 ○	White
C1 ●	Copper Anodized
S1 ●	Brass Anodized

Available from 30/09/2019

Housing for plasterboard ⌀ 6,5cm			
●	1Z00.055.01	Single	€ 18,00
●●	1Z00.055.2L	Double	€ 33,00
●●●	1Z00.055.3L	Triple	€ 49,00
Housing for brickwork			
●	1M00.055.01		€ 90,00

easy Pop 01 small Bulb with trim (for plasterboard and brickwork)

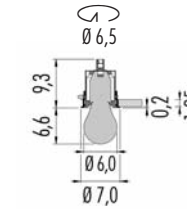

IP20	ⓘ	CE	▽	□
220V ÷ 240V	e27 led 4W	CRI>80		
3E01.A2L.□	dimmi IGBT - TRIAC	€ 90,00		
■ Led color	Nominal lm	▲ Beam spread		
2700 °K	470	360°		

easy Pop 01 big Bulb with trim (for plasterboard and brickwork)

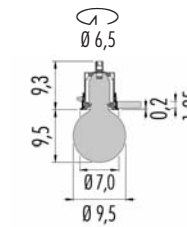

IP20	ⓘ	CE	▽	□
220V ÷ 240V	e27 led 4W	CRI>80		
3E01.B2L.□	dimmi IGBT - TRIAC	€ 95,00		
■ Led color	Nominal lm	▲ Beam spread		
2700 °K	470	360°		

□	Frame
02 ●	Black
06 ○	White
C1 ●	Copper Anodized
S1 ●	Brass Anodized

Available from 30/09/2019

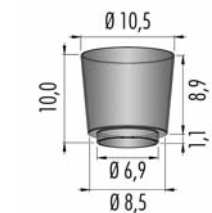

Housing for brickwork

●	1E00.055.01	€ 20,00
---	-------------	---------

Pop 01 Static Ø 12,5 trimless (for plasterboard and brickwork)

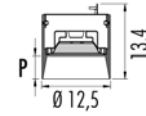

IP20	CE	V	⊕
12V			
3P01.530.□	653	max 50W	€ 118,00
3KIT.201.050		max 50VA	€ 32,00
Dimmable gear: IGBT			

□	Frame
02 ●	Black
06 ○	White

	P
3P01.530.□	4,4
3P01.6■▲□	4,0
3P01.6■▲9□	4,2

Housing for plasterboard ⌀ 14,0cm			
●	1Z00.125.01	Single	€ 40,00
●●	1Z00.125.2L	Double	€ 75,00
●●●	1Z00.125.3L	Triple <small>ROS</small>	€ 106,00

Housing for brickwork			
●	1M00.125.01		€ 139,00

IP40	MC-E=3	CE	V	⊕
350 - 500 - 700 m/A				CRI>90
3P01.6■▲□				€ 180,00 ▼

IP54	MC-E=3	CE	V	⊕
350 - 500 - 700 m/A				CRI>90
3P01.6■▲9□				€ 190,00 ▼

© (m-M)	LED 12,5W	350m/A
3KIT.350.1L (1-1)	on/off	€ 21,00
3KIT.351.40 (1-3)	DALI - Push - 1...10V	€ 105,00
3KIT.352.15 (1-1)	DALI	€ 59,00
3KIT.353.15 (1-1)	Push - 1...10V	€ 59,00
3KIT.354.18 (1-1)	IGBT - TRIAC	€ 32,00
■ Led color	Nominal lm	▲ Beam spread
2 = 2700°K	1477	L = 60°
3 = 3000°K	1565	S = 24°
4 = 4000°K	1635	T = 12°

© (m-M)	LED 18,4W	500m/A
3KIT.500.1L (1-1)	on/off	€ 21,00
3KIT.501.50 (1-3)	DALI - Push - 1...10V	€ 105,00
3KIT.502.20 (1-1)	DALI	€ 59,00
3KIT.503.20 (1-1)	Push - 1...10V	€ 59,00
3KIT.504.20 (1-1)	IGBT - TRIAC	€ 32,00
■ Led color	Nominal lm	▲ Beam spread
2 = 2700°K	2020	L = 60°
3 = 3000°K	2140	S = 24°
4 = 4000°K	2236	T = 12°

© (m-M)	LED 27W	700m/A
3KIT.700.1L (1-1)	on/off	€ 24,00
3KIT.701.50 (1-1)	DALI - Push - 1...10V	€ 105,00
■ Led color	Nominal lm	▲ Beam spread
2 = 2700°K	2683	L = 60°
3 = 3000°K	2842	S = 24°
4 = 4000°K	2963	T = 12°

Emergency unit: (inverter + battery. Driver not included)

3KIT.900.01 (1-1)	1:00 hour	€ 95,00
3KIT.900.03 (1-1)	3:00 hours	€ 137,00

(m-M) = min. Led unit - Max Led unit.
Led and Emergency unit, warranty only when used
together with driver bought from Oty srl.

Pop 01 Dynamic Ø 12,5 trimless (for plasterboard and brickwork)

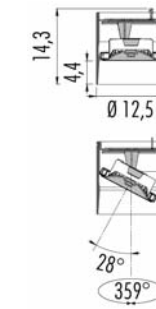

□ Frame

02 ● Black

06 ○ White

Housing for plasterboard ⤴ Ø 14,0cm

●	1Z00.125.01	Single	€ 40,00
●●	1Z00.125.2L	Double	€ 75,00
●●●	1Z00.125.3L	Triple <small>ROS</small>	€ 106,00

Housing for brickwork

●	1M00.125.01	€ 139,00
---	-------------	----------

IP20

CE

12V

3P01D.530.□ 653 max 50W € 182,00

3KIT.201.050 max 50VA € 32,00

Dimmable gear: IGBT

IP40

MC-E=3

CE

350 - 500 m/A

CRI>90

3P01D.6 € 240,00 ▼

© (m-M) LED 12,5W 350m/A

3KIT.350.1L (1-1) on/off € 21,00

3KIT.351.40 (1-3) DALI - Push - 1...10V € 105,00

3KIT.352.15 (1-1) DALI € 59,00

3KIT.353.15 (1-1) Push - 1...10V € 59,00

3KIT.354.18 (1-1) IGBT - TRIAC € 32,00

■ Led color Nominal lm ▲ Beam spread

2 = 2700°K 1477 L = 60°

3 = 3000°K 1565 S = 24°

4 = 4000°K 1635 T = 12°

© (m-M) LED 18,4W 500m/A

3KIT.500.1L (1-1) on/off € 21,00

3KIT.501.50 (1-3) DALI - Push - 1...10V € 105,00

3KIT.502.20 (1-1) DALI € 59,00

3KIT.503.20 (1-1) Push - 1...10V € 59,00

3KIT.504.20 (1-1) IGBT - TRIAC € 32,00

■ Led color Nominal lm ▲ Beam spread

2 = 2700°K 2020 L = 60°

3 = 3000°K 2140 S = 24°

4 = 4000°K 2236 T = 12°

Emergency unit: (inverter + battery. Driver not included)

3KIT.900.01 (1-1) 1:00 hour/ora € 95,00

3KIT.900.03 (1-1) 3:00 hours/ore € 137,00

(m-M) = min. Led unit - Max Led unit.
Led and Emergency unit, warranty only when used
together with driver bought from Oty srl.

Pop 02 Ø 5,5 trimless (for plasterboard and brickwork)

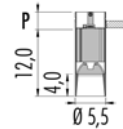
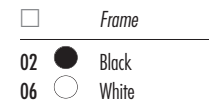

Pop P02	P
3P02.210.□	GU10 4,7
3P02.211.□	GU10 led —
4P02.211.□	GU10 led + honeycomb —
3P02.220.□	GU5.3 4,7
4P02.220.□	GU5.3 led + honeycomb —
3P02.3.□	led IP40 4,7
4P02.3.□	led IP40 + honeycomb 4,7
3P02.3W.□	led IP40 4,7
4P02.3W.□	led IP40 + honeycomb 4,7

Housing for plasterboard Ø 6,5cm

● 1Z00.055.01	Single	€ 18,00
●● 1Z00.055.2L	Double	€ 33,00
●●● 1Z00.055.3L	Triple	€ 49,00

Housing for brickwork

● 1M00.055.01	Single	€ 90,00
---------------	--------	---------

(m-M) = min. Led unit - Max Led unit.
Led and Emergency unit, warranty only when used together with driver bought from Oty srl.

IP20	CE	V	□
220V ÷ 240V			
3P02.210.□	GU10 max 50W	€ 55,00	
3P02.211.□	GU10 led	€ 55,00	
4P02.211.□	GU10 led	€ 56,00	
With honeycomb			

IP20	CE	V	⊕
12V			
3P02.220.□	GU5.3 max 50W	€ 50,00	
4P02.220.□	GU5.3 led	€ 56,00	
With honeycomb			
3KIT.201.050	max 50VA	€ 32,00	
Dimmable gear: IGBT			

IP40	MC-E=3	CE	V	⊕
350m/A	LED 11W			
3P02.3.□	LED 11W	€ 110,00		
4P02.3.□	LED 11W	€ 116,00		
With honeycomb				

Led color	Nominal lm	Beam spread
2 = 2700°K	1195	S = 22°
3 = 3000°K	1257	T = 12°
4 = 4000°K	1313	

(m-M)	Driver	
3KIT.350.1L (1-1)	on/off	€ 21,00
3KIT.351.40 (1-3)	DALI - Push - 1...10V Remote installation	€ 105,00
3KIT.352.15 (1-1)	DALI	€ 59,00
3KIT.353.15 (1-1)	Push - 1...10V	€ 59,00
3KIT.354.18 (1-1)	IGBT - TRIAC	€ 32,00

IP40	DimToWarm	CE	V	⊕
220V ÷ 240V	LED 6W			
3P02.3W.□	dim IGBT - TRIAC	€ 150,00		
4P02.3W.□	dim IGBT - TRIAC	€ 156,00		
With honeycomb				

Led color	Nominal lm	Beam spread
W= max 3000°K	max 445 lm	M = 30°
min. 1800°K	min. 10 lm	S = 18°

easy Pop 02 Ø 5,5 with trim (for plasterboard and brickwork)

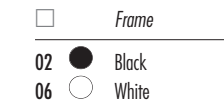

Available from 30/09/2019

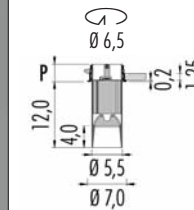

easy Pop E02	P
3E02.210.□	GU10 4,7
3E02.211.□	GU10 led —
4E02.211.□	GU10 led + honeycomb —
3E02.220.□	GU5.3 4,7
4E02.220.□	GU5.3 led + honeycomb —
3E02.3.□	led IP40 4,7
4E02.3.□	led IP40 + honeycomb 4,7
3E02.3W.□	led IP40 4,7
4E02.3W.□	led IP40 + honeycomb 4,7

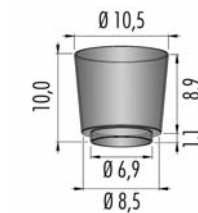

● 1E00.055.01	€ 20,00
---------------	---------

(m-M) = min. Led unit - Max Led unit.
Led and Emergency unit, warranty only when used together with driver bought from Oty srl.

IP20	CE	V	□
220V ÷ 240V			
3E02.210.□	GU10 max 50W	€ 75,00	
3E02.211.□	GU10 led	€ 75,00	
4E02.211.□	GU10 led	€ 81,00	
With honeycomb			

IP20	CE	V	⊕
12V			
3E02.220.□	GU5.3 max 50W	€ 70,00	
4E02.220.□	GU5.3 led	€ 76,00	
With honeycomb			
3KIT.201.050	max 50VA	€ 32,00	
Dimmable gear: IGBT			

IP40	MC-E=3	CE	V	⊕
350m/A	LED 11W			
3E02.3.□	LED 11W	€ 110,00		
4E02.3.□	LED 11W	€ 116,00		
With honeycomb				

Led color	Nominal lm	Beam spread
2 = 2700°K	1195	S = 22°
3 = 3000°K	1257	T = 12°
4 = 4000°K	1313	

(m-M)	Driver	
3KIT.350.1L (1-1)	on/off	€ 21,00
3KIT.351.40 (1-3)	DALI - Push - 1...10V Remote installation	€ 105,00
3KIT.352.15 (1-1)	DALI	€ 59,00
3KIT.353.15 (1-1)	Push - 1...10V	€ 59,00
3KIT.354.18 (1-1)	IGBT - TRIAC	€ 32,00

IP40	DimToWarm	CE	V	⊕
220V ÷ 240V	LED 6W			
3E02.3W.□	dim IGBT - TRIAC	€ 165,00		
4E02.3W.□	dim IGBT - TRIAC	€ 171,00		
With honeycomb				

Led color	Nominal lm	Beam spread
W= max 3000°K	max 445 lm	M = 30°
min. 1800°K	min. 10 lm	S = 18°

Pop 03 Ø 6,0 trimless (only for plasterboard)

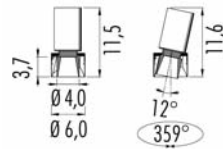
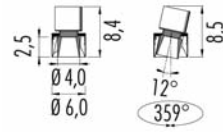

Frame	Color
02	Black
06	White
C1	Copper Anodized
S1	Brass Anodized

Finishes C1 and S1 are available from 30/09/2019

IP20	CE	V	⚡
12V			
3P03.200.□	GU4	max 35W	€ 54,00
3KIT.201.050		max 50VA	€ 32,00
Dimmable gear: IGBT			

IP40	CE	V	⚡
350m/A			
3P03.2	LED 11W		€ 113,00
■ Led color	Nominal lm	▲ Beam spread	
2 = 2700°K	1195	22°	
3 = 3000°K	1257		
4 = 4000°K	1313		

© (m-M)	Driver	Price
3KIT.350.1L (1-1)	on/off	€ 21,00
3KIT.350.25 (2-2)	on/off	€ 35,00
3KIT.351.40 (1-3)	DALI - Push - 1...10V Remote installation	€ 105,00
3KIT.352.15 (1-1)	DALI	€ 59,00
3KIT.353.15 (1-1)	Push - 1...10V	€ 59,00
3KIT.354.18 (1-1)	IGBT - TRIAC	€ 32,00

Emergency unit: (inverter + battery. Driver not included)		
3KIT.900.01 (1-1)	1:00 hour	€ 95,00
3KIT.900.03 (1-1)	3:00 hours Remote installation	€ 137,00

Housing for plasterboard ↻ Ø 7,6cm

● 1Z00.060.01	€ 29,00
---------------	---------

(m-M) = min. Led unit - Max Led unit.
Led and Emergency unit, warranty only when used together with driver bought from Oty srl.

Pop 03 NaNo Ø 6,0 trimless (only for plasterboard)

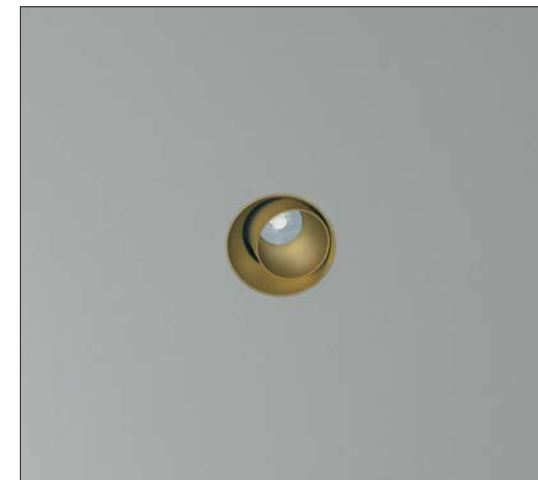
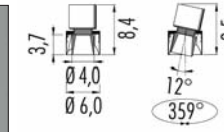

Frame	Color
02	Black
06	White
C1	Copper Anodized
S1	Brass Anodized

Available from 30/09/2019

IP40	CE	V	⚡
250m/A			
3N03.2	LED 8W		€ 95,00
■ Led color	Nominal lm	▲ Beam spread	
2 = 2700°K	779	22°	
3 = 3000°K	819		
4 = 4000°K	855		

© (m-M)	Driver	Price
3KIT.250.1L (1-1)	on/off	€ 21,00
3KIT.251.28 (1-3)	DALI - Push - 1...10V Remote installation	€ 105,00
3KIT.252.12 (1-1)	DALI	€ 59,00
3KIT.253.13 (1-1)	Push - 1...10V	€ 59,00
3KIT.254.12 (1-1)	IGBT - TRIAC	€ 32,00

Emergency unit: (inverter + battery. Driver not included)		
3KIT.900.01 (1-1)	1:00 hour	€ 95,00
3KIT.900.03 (1-1)	3:00 hours Remote installation	€ 137,00

Housing for plasterboard ↻ Ø 7,6cm

● 1Z00.060.01	€ 29,00
---------------	---------

(m-M) = min. Led unit - Max Led unit.
Led and Emergency unit, warranty only when used together with driver bought from Oty srl.

Pop 03 Ø 8,0 trimless (for plasterboard and brickwork)

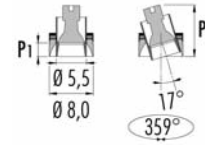

Frame	Color
02	Black
06	White
C1	Copper Anodized
S1	Brass Anodized

Finishes C1 and S1 are available from 30/09/2019

Pop 03	P	P1
3P03.210.□ GU10	11,0	2,5
3P03.211.□ GU10 led	—	2,5
4P03.211.□ GU10 led + honeycomb	—	2,5
3P03.220.□ GU5.3	9,4	2,5
4P03.220.□ GU5.3 led + honeycomb	—	2,5
3P03.K■S.□ led 9,5W IP40	11,4	2,5
4P03.K■S.□ led 9,5W IP40 + honeycomb	11,9	2,5

IP20	CE	▽	□
220V ÷ 240V			
3P03.210.□ GU10 max 50W	€	70,00	
3P03.211.□ GU10 led	€	70,00	
4P03.211.□ GU10 led	€	76,00	
With honeycomb			

IP20	CE	▽	⊕
12V			
3P03.220.□ GU5.3 max 50W	€	60,00	
4P03.220.□ GU5.3 led	€	66,00	
With honeycomb			
3KIT.201.050 max 50VA	€	32,00	
Dimmable gear: IGBT			

IP40	Flicker < 20%	CE	▽	□
220V ÷ 240V	LED 9,5W			CRI>90
3P03.K■S.□ dimm IGBT - TRIAC	€	99,00		
4P03.K■S.□ dimm IGBT - TRIAC	€	105,00		
With honeycomb				
■ Led color	Nominal lm	▲ Beam spread		
2 = 2700°K	710	24°		
3 = 3000°K	760			

Housing for plasterboard ↻ Ø 9,5cm			
●	1Z00.080.01	Single	€ 33,00
●●	1Z00.080.2L	Double	€ 61,00
●●●	1Z00.080.3L	Triple	€ 89,00
Housing for brickwork			
●	1M00.080.01		€ 96,00

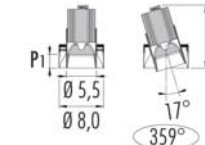

Frame	Color
02	Black
06	White
C1	Copper Anodized
S1	Brass Anodized

Finishes C1 and S1 are available from 30/09/2019

Pop 03	P	P1
3P03.3■M.□ led IP40	10,5	0,5
3P03.3■S.□ led IP40	11,4	2,5
3P03.3■T.□ led IP40	9,4	0,5
4P03.3■M.□ led IP40 + honeycomb	11,0	0,5
4P03.3■S.□ led IP40 + honeycomb	11,9	2,5
4P03.3■T.□ led IP40 + honeycomb	9,9	0,5
3P03.3WM.□ led IP40	6,8	0,5
3P03.3WS.□ led IP40	8,8	2,5
4P03.3WM.□ led IP40 + honeycomb	7,3	0,5
4P03.3WS.□ led IP40 + honeycomb	9,3	2,5

IP40	MC-E=3	CE	▽	⊕
350m/A	LED 11W			CRI>90
3P03.3■M.□	€	135,00		
4P03.3■M.□	€	141,00		
With honeycomb				
■ Led color	Nominal lm	▲ Beam spread		
2 = 2700°K	1195	M = 38°		
3 = 3000°K	1257	S = 22°		
4 = 4000°K	1313	T = 10°		

(m-M)	Driver	Price
3KIT.350.1L (1-1)	on/off	€ 21,00
3KIT.351.40 (1-3)	DALI - Push - 1...10V Remote installation	€ 105,00
3KIT.352.15 (1-1)	DALI	€ 59,00
3KIT.353.15 (1-1)	Push - 1...10V	€ 59,00
3KIT.354.18 (1-1)	IGBT - TRIAC	€ 32,00

Emergency unit: (inverter + battery. Driver not included)		
3KIT.900.01 (1-1)	1:00 hour/ora	€ 95,00
3KIT.900.03 (1-1)	3:00 hours/ore	€ 137,00

IP40	DimToWarm	CE	▽	⊕
220V ÷ 240V	LED 6W			CRI 95 Driver included
3P03.3W■.□ dimm IGBT - TRIAC	€	160,00		
4P03.3W■.□ dimm IGBT - TRIAC	€	166,00		
With honeycomb				
■ Led color	Nominal lm	▲ Beam spread		
W= max 3000°K	max 445 lm	M = 30°		
min. 1800°K	min. 10 lm	S = 18°		

Housing for plasterboard ↻ Ø 9,5cm			
●	1Z00.080.01	Single	€ 33,00
●●	1Z00.080.2L	Double	€ 61,00
●●●	1Z00.080.3L	Triple	€ 89,00
Housing for brickwork			
●	1M00.080.01		€ 96,00

(m-M) = min. Led unit - Max Led unit.
Led and Emergency unit, warranty only when used together with driver bought from Oty srl.

Pop 03 NaNo Ø 8,0 trimless (for plasterboard and brickwork)

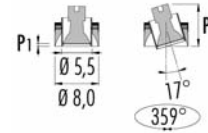

Frame	Color
02	Black
06	White
C1	Copper Anodized
S1	Brass Anodized

Finishes C1 and S1 are available from 30/09/2019

Pop NaNo N03	P	P1
3N03.210.□ GU10	9,1	0,5
3N03.211.□ GU10 led	—	0,5
4N03.211.□ GU10 led + honeycomb	—	0,5
3N03.220.□ GU5.3	7,5	0,5
4N03.220.□ GU5.3 led + honeycomb	—	0,5
3N03.K■S.□ led 9,5W IP40	10,0	0,5
4N03.K■S.□ led 9,5W IP40 + honeycomb	10,5	0,5

IP20	CE	▽	□
220V ÷ 240V			
3N03.210.□ GU10 max 50W	€	70,00	
3N03.211.□ GU10 led	€	70,00	
4N03.211.□ GU10 led	€	76,00	
With honeycomb			

IP20	CE	▽	⊕
12V			
3N03.220.□ GU5.3 max 50W	€	60,00	
4N03.220.□ GU5.3 led	€	66,00	
With honeycomb			
3KIT.201.050 max 50VA	€	32,00	
Dimmable gear: IGBT			

IP40	Flicker < 20%	CE	▽	□
220V ÷ 240V	LED 9,5W			CRI>90
3N03.K■S.□ dimm IGBT - TRIAC	€	99,00		
4N03.K■S.□ dimm IGBT - TRIAC	€	105,00		
With honeycomb				
■ Led color	Nominal lm	▲ Beam spread		
2 = 2700°K	710	24°		
3 = 3000°K	760			

Housing for plasterboard ↻ Ø 9,5cm			
●	1Z00.080.01	Single	€ 33,00
●●	1Z00.080.2L	Double	€ 61,00
●●●	1Z00.080.3L	Triple	€ 89,00
Housing for brickwork			
●	1M00.080.01		€ 96,00

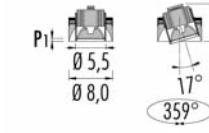

Frame	Color
02	Black
06	White
C1	Copper Anodized
S1	Brass Anodized

Available from 30/09/2019

Pop NaNo N03	P	P1
3N03.3■M.□ led IP40	7,8	0,5
3N03.3■S.□ led IP40	6,8	0,5
3N03.3■T.□ led IP40	6,8	0,5
4N03.3■M.□ led IP40 + honeycomb	8,3	0,5
4N03.3■S.□ led IP40 + honeycomb	7,3	0,5
4N03.3■T.□ led IP40 + honeycomb	7,3	0,5

IP40	MC-E=3	CE	▽	⊕
250m/A	LED 8W			CRI>90
3N03.3■M.□	€	100,00		
4N03.3■M.□	€	106,00		
With honeycomb				

■ Led color	Nominal lm	▲ Beam spread
2 = 2700°K	779	M = 38°
3 = 3000°K	819	S = 22°
4 = 4000°K	855	T = 10°

© (m-M)	Driver	Price
3KIT.250.1L (1-1)	on/off	€ 21,00
3KIT.251.28 (1-3)	DALI - Push - 1...10V Remote installation	€ 105,00
3KIT.252.12 (1-1)	DALI	€ 59,00
3KIT.253.13 (1-1)	Push - 1...10V	€ 59,00
3KIT.254.12 (1-1)	IGBT - TRIAC	€ 32,00

Emergency unit: (inverter + battery. Driver not included)		
3KIT.900.01 (1-1)	1:00 hour/ora	€ 95,00
3KIT.900.03 (1-1)	3:00 hours/ore	€ 137,00

Housing for plasterboard ↻ Ø 9,5cm			
●	1Z00.080.01	Single	€ 33,00
●●	1Z00.080.2L	Double	€ 61,00
●●●	1Z00.080.3L	Triple	€ 89,00
Housing for brickwork			
●	1M00.080.01		€ 96,00

(m-M) = min. Led unit - Max Led unit.
Led and Emergency unit, warranty only when used together with driver bought from Oty srl.

easy Pop 03 Ø 8,0 with trim (for plasterboard and brickwork)

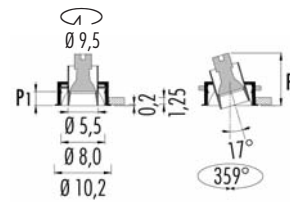

Frame	Color
02	Black
06	White
C1	Copper Anodized
S1	Brass Anodized

Available from 30/09/2019

easy Pop E03		P	P1
3E03.210.□	GU10	11,0	2,5
3E03.211.□	GU10 led	—	2,5
4E03.211.□	GU10 led + honeycomb	—	2,5
3E03.220.□	GU5.3	9,4	2,5
4E03.220.□	GU5.3 led + honeycomb	—	2,5
3E03.K■S.□	led 9,5W IP40	11,4	2,5
4E03.K■S.□	led 9,5W IP40 + honeycomb	11,9	2,5

IP20	CE	V	□
220V ÷ 240V			
3E03.210.□	GU10	max 50W	€ 99,00
3E03.211.□	GU10	led	€ 99,00
4E03.211.□	GU10	led	€ 105,00
With honeycomb			

IP20	CE	V	⊕
12V			
3E03.220.□	GU5.3	max 50W	€ 95,00
4E03.220.□	GU5.3	led	€ 101,00
With honeycomb			
3KIT.201.050		max 50VA	€ 32,00
Dimmable gear: IGBT			

IP40	Flicker < 20%	CE	V	□
220V ÷ 240V	LED 9,5W			CRI > 90
3E03.K■S.□	dim IGBT - TRIAC			€ 130,00
4E03.K■S.□	dim IGBT - TRIAC			€ 136,00
With honeycomb				
■ Led color	Nominal lm	▲ Beam spread		
2 = 2700°K	710	24°		
3 = 3000°K	760			

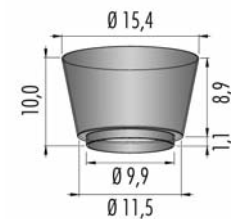

Housing for brickwork

● 1E00.080.01	€ 25,00
---------------	---------

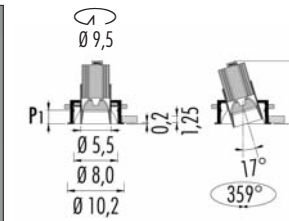

Frame	Color
02	Black
06	White
C1	Copper Anodized
S1	Brass Anodized

Available from 30/09/2019

easy Pop E03		P	P1
3E03.3■M.□	led IP40	10,5	0,5
3E03.3■S.□	led IP40	11,4	2,5
3E03.3■T.□	led IP40	9,4	0,5
4E03.3■M.□	led IP40 + honeycomb	11,0	0,5
4E03.3■S.□	led IP40 + honeycomb	11,9	2,5
4E03.3■T.□	led IP40 + honeycomb	9,9	0,5
3E03.3WM.□	led IP40	6,8	0,5
3E03.3WS.□	led IP40	8,8	2,5
4E03.3WM.□	led IP40 + honeycomb	7,3	0,5
4E03.3WS.□	led IP40 + honeycomb	9,3	2,5

IP40	MC-E=3	CE	V	⊕
350m/A	LED 11W			CRI > 90
3E03.3■M.□				€ 130,00
4E03.3■M.□				€ 136,00
With honeycomb				
■ Led color	Nominal lm	▲ Beam spread		
2 = 2700°K	1195	M = 38°		
3 = 3000°K	1257	S = 22°		
4 = 4000°K	1313	T = 10°		

© (m-M) Driver

3KIT.350.1L (1-1)	on/off	€ 21,00
3KIT.351.40 (1-3)	DALI - Push - 1...10V Remote installation	€ 105,00
3KIT.352.15 (1-1)	DALI	€ 59,00
3KIT.353.15 (1-1)	Push - 1...10V	€ 59,00
3KIT.354.18 (1-1)	IGBT - TRIAC	€ 32,00

Emergency unit: (inverter + battery. Driver not included)

3KIT.900.01 (1-1)	1:00 hour/ora	€ 95,00
3KIT.900.03 (1-1)	3:00 hours/ore	€ 137,00

IP40	DimToWarm	CE	V	⊕
220V ÷ 240V	LED 6W			CRI 95
3E03.3W■.□	dim IGBT - TRIAC			€ 180,00
4E03.3W■.□	dim IGBT - TRIAC			€ 186,00
With honeycomb				

■ Led color	Nominal lm	▲ Beam spread
W = max 3000°K	max 445 lm	M = 30°
min. 1800°K	min. 10 lm	S = 18°

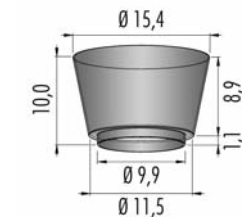

Housing for brickwork

● 1E00.080.01	€ 25,00
---------------	---------

(m-M) = min. Led unit - Max Led unit.
Led and Emergency unit, warranty only when used
together with driver bought from Oty srl.

easy Pop 03 NaNo Ø 8,0 with trim (for plasterboard and brickwork)

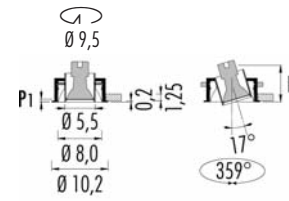

Frame	Color
02	Black
06	White
C1	Copper Anodized
S1	Brass Anodized

Available from 30/09/2019

easy NaNo Pop F03		P	P1
3F03.210.□	GU10	9,1	0,5
3F03.211.□	GU10 led	—	0,5
4F03.211.□	GU10 led + honeycomb	—	0,5
3F03.220.□	GU5.3	7,5	0,5
4F03.220.□	GU5.3 led + honeycomb	—	0,5
3F03.K■S.□	led 9,5W IP40	10,0	0,5
4F03.K■S.□	led 9,5W IP40 + honeycomb	10,5	0,5

IP20	CE	V	□
220V ÷ 240V			
3F03.210.□	GU10	max 50W	€ 99,00
3F03.211.□	GU10	led	€ 99,00
4F03.211.□	GU10	led	€ 105,00
With honeycomb			

IP20	CE	V	⊕
12V			
3F03.220.□	GU5.3	max 50W	€ 95,00
4F03.220.□	GU5.3	led	€ 101,00
With honeycomb			
3KIT.201.050		max 50VA	€ 32,00
Dimmable gear: IGBT			

IP40	Flicker < 20%	CE	V	□
220V ÷ 240V	LED 9,5W			CRI>90
3F03.K■S.□	dim IGBT - TRIAC		€ 130,00	
4F03.K■S.□	dim IGBT - TRIAC		€ 136,00	
With honeycomb				

Led color	Nominal lm	Beam spread
2 = 2700°K	710	24°
3 = 3000°K	760	

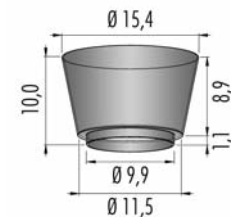

Housing for brickwork

● 1E00.080.01	€ 25,00
---------------	---------

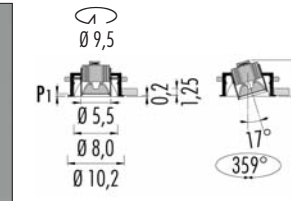

Frame	Color
02	Black
06	White
C1	Copper Anodized
S1	Brass Anodized

Available from 30/09/2019

easy NaNo Pop F03		P	P1
3F03.3■M.□	led IP40	7,8	0,5
3F03.3■S.□	led IP40	6,8	0,5
3F03.3■T.□	led IP40	6,8	0,5
4F03.3■M.□	led IP40 + honeycomb	8,3	0,5
4F03.3■S.□	led IP40 + honeycomb	7,3	0,5
4F03.3■T.□	led IP40 + honeycomb	7,3	0,5

(m-M) = min. Led unit - Max Led unit.
Led and Emergency unit, warranty only when used together with driver bought from Oty srl.

IP40	MC-E=3	CE	V	⊕
250m/A	LED 8W			CRI>90
3F03.3■M.□			€ 130,00	
4F03.3■M.□			€ 136,00	
With honeycomb				
Led color	Nominal lm	Beam spread		
2 = 2700°K	779	M = 38°		
3 = 3000°K	819	S = 22°		
4 = 4000°K	855	T = 10°		

(m-M)	Driver	Price
3KIT.250.1L (1-1)	on/off	€ 21,00
3KIT.251.28 (1-3)	DALI - Push - 1...10V Remote installation	€ 105,00
3KIT.252.12 (1-1)	DALI	€ 59,00
3KIT.253.13 (1-1)	Push - 1...10V	€ 59,00
3KIT.254.12 (1-1)	IGBT - TRIAC	€ 32,00

Emergency unit: (inverter + battery. Driver not included)		
3KIT.900.01 (1-1)	1:00 hour/ora	€ 95,00
3KIT.900.03 (1-1)	3:00 hours/ore	€ 137,00

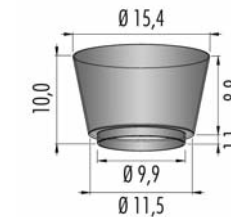

Housing for brickwork

● 1E00.080.01	€ 25,00
---------------	---------

Pop X3 Ø 10,0 trimless (only for plasterboard)

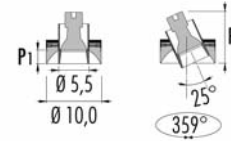

□	Frame
02	Black
06	White
C1	Copper Anodized
S1	Brass Anodized

Available from 30/09/2019

Pop PX3	P	P1
3PX3.210.□ GU10	10,9	2,5
3PX3.211.□ GU10 led	—	2,5
4PX3.211.□ GU10 led + honeycomb	—	2,5
3PX3.K■S.□ led 9,5W IP40	11,4	2,5
4PX3.K■S.□ led 9,5W IP40 + honeycomb	11,9	2,5

IP20	CE	▽	□
220V ÷ 240V			
3PX3.210.□ GU10 max 50W	€	75,00	
3PX3.211.□ GU10 led	€	75,00	
4PX3.211.□ GU10 led	€	81,00	
<i>With honeycomb</i>			
IP40	Flicker < 20%	CE	▽
220V ÷ 240V	LED 9,5W	CRI > 90	
3PX3.K■S.□ dimm IGBT - TRIAC	€	105,00	
4PX3.K■S.□ dimm IGBT - TRIAC	€	111,00	
<i>With honeycomb</i>			
■ Led color	Nominal lm	▲ Beam spread	
2 = 2700°K	710	24°	
3 = 3000°K	760		

Housing for plasterboard	€
● 1Z00.100.01 ⌀ 11,4cm	45,00

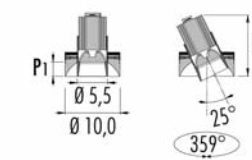
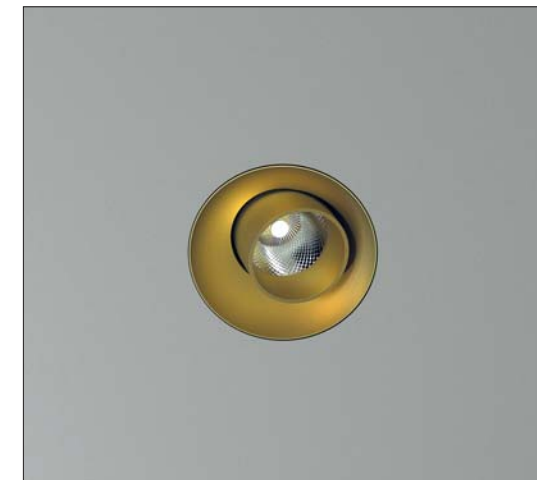

□	Frame
02	Black
06	White
C1	Copper Anodized
S1	Brass Anodized

Available from 30/09/2019

Pop PX3	P	P1
3PX3.3■M.□ led IP40	10,5	0,5
3PX3.3■S.□ led IP40	11,4	2,5
3PX3.3■T.□ led IP40	9,4	0,5
4PX3.3■M.□ led IP40 + honeycomb	11,0	0,5
4PX3.3■S.□ led IP40 + honeycomb	11,9	2,5
4PX3.3■T.□ led IP40 + honeycomb	9,9	0,5
3PX3.3WM.□ led IP40	6,8	0,5
3PX3.3WS.□ led IP40	8,8	2,5
4PX3.3WM.□ led IP40 + honeycomb	7,3	0,5
4PX3.3WS.□ led IP40 + honeycomb	9,3	2,5

IP40	MC-E=3	CE	▽	□
350m/A	LED 11W	CRI > 90		
3PX3.3■M.□	€	135,00		
4PX3.3■M.□	€	141,00		
<i>With honeycomb</i>				
■ Led color	Nominal lm	▲ Beam spread		
2 = 2700°K	1195	M = 38°		
3 = 3000°K	1257	S = 22°		
4 = 4000°K	1313	T = 10°		

© (m-M)	Driver	€
3KIT.350.1L (1-1)	on/off	21,00
3KIT.351.40 (1-3)	DALI - Push - 1...10V Remote installation	105,00
3KIT.352.15 (1-1)	DALI	59,00
3KIT.353.15 (1-1)	Push - 1...10V	59,00
3KIT.354.18 (1-1)	IGBT - TRIAC	32,00
Emergency unit: (inverter + battery. Driver not included)		
3KIT.900.01 (1-1)	1:00 hour/ora	95,00
3KIT.900.03 (1-1)	3:00 hours/ore	137,00

IP40	DimToWarm	CE	▽	□
220V ÷ 240V	LED 6W	CRI 95	Driver included	
3PX3.3W■.□ dimm IGBT - TRIAC	€	160,00		
4PX3.3W■.□ dimm IGBT - TRIAC	€	166,00		
<i>With honeycomb</i>				
■ Led color	Nominal lm	▲ Beam spread		
W= max 3000°K min. 1800°K	max 445 lm min. 10 lm	M = 30° S = 18°		

Housing for plasterboard	€
● 1Z00.100.01 ⌀ 11,4cm	45,00

(m-M) = min. Led unit - Max Led unit.
Led and Emergency unit, warranty only when used
together with driver bought from Oty srl.

Pop X3 NaNo Ø 10,0 trimless (only for plasterboard)

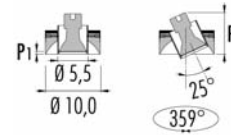

Frame	Color
02	Black
06	White
C1	Copper Anodized
S1	Brass Anodized

Available from 30/09/2019

Pop NaNo NX3	P	P1
3NX3.210.□ GU10	9,1	0,5
3NX3.211.□ GU10 led	—	0,5
4NX3.211.□ GU10 led + honeycomb	—	0,5
3NX3.K■S.□ led 9,5W IP40	10,0	0,5
4NX3.K■S.□ led 9,5W IP40 + honeycomb	10,5	0,5

IP20	CE	▽	□
220V ÷ 240V			
3NX3.210.□ GU10 max 50W	€	75,00	
3NX3.211.□ GU10 led	€	75,00	
4NX3.211.□ GU10 led	€	81,00	
With honeycomb			

IP40	Flicker < 20%	CE	▽	□
220V ÷ 240V	LED 9,5W			
3NX3.K■S.□ dimm IGBT - TRIAC	€	105,00		
4NX3.K■S.□ dimm IGBT - TRIAC	€	111,00		
With honeycomb				

Led color	Nominal lm	Beam spread
2 = 2700°K	710	24°
3 = 3000°K	760	

Housing for plasterboard	Ø	Price
● 1Z00.100.01	Ø 11,4cm	€ 45,00

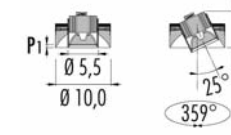

Frame	Color
02	Black
06	White
C1	Copper Anodized
S1	Brass Anodized

Available from 30/09/2019

Pop NaNo NX3	P	P1
3NX3.3■M.□ led IP40	7,8	0,5
3NX3.3■S.□ led IP40	6,8	0,5
3NX3.3■T.□ led IP40	6,8	0,5
4NX3.3■M.□ led IP40 + honeycomb	8,3	0,5
4NX3.3■S.□ led IP40 + honeycomb	7,3	0,5
4NX3.3■T.□ led IP40 + honeycomb	7,3	0,5

IP40	MC-E=3	CE	▽	□
250m/A	LED 8W			
3NX3.3■M.□	€	120,00		
4NX3.3■M.□	€	126,00		
With honeycomb				

Led color	Nominal lm	Beam spread
2 = 2700°K	779	M = 38°
3 = 3000°K	819	S = 22°
4 = 4000°K	855	T = 10°

(m-M) Driver

3KIT.250.1L (1-1) on/off	€	21,00
3KIT.251.28 (1-3) DALI - Push - 1...10V Remote installation	€	105,00
3KIT.252.12 (1-1) DALI	€	59,00
3KIT.253.13 (1-1) Push - 1...10V	€	59,00
3KIT.254.12 (1-1) IGBT - TRIAC	€	32,00

Emergency unit: (inverter + battery. Driver not included)

3KIT.900.01 (1-1) 1:00 hour/ora	€	95,00
3KIT.900.03 (1-1) 3:00 hours/ore	€	137,00

Housing for plasterboard	Ø	Price
● 1Z00.100.01	Ø 11,4cm	€ 45,00

(m-M) = min. Led unit - Max Led unit.
Led and Emergency unit, warranty only when used together with driver bought from Oty srl.

easy Pop X3 Ø 10,0 with trim (for plasterboard and brickwork)

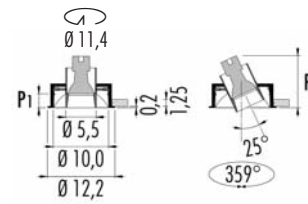

Frame	Color
02	Black
06	White
C1	Copper Anodized
S1	Brass Anodized

Available from 30/09/2019

easy Pop EX3		P	P1
3EX3.210.□	GU10	10,9	2,5
3EX3.211.□	GU10 led	—	2,5
4EX3.211.□	GU10 led + honeycomb	—	2,5
3EX3.K■S.□	led 9,5W IP40	11,4	2,5
4EX3.K■S.□	led 9,5W IP40 + honeycomb	11,9	2,5

IP20		CE	V	□
220V ÷ 240V				
3EX3.210.□	GU10 max 50W	€	120,00	
3EX3.211.□	GU10 led	€	120,00	
4EX3.211.□	GU10 led	€	126,00	
<i>With honeycomb</i>				
IP40 Flicker < 20% CE V □				
220V ÷ 240V LED 9,5W CRI>90				
3EX3.K■S.□	dim IGBT - TRIAC	€	145,00	
4EX3.K■S.□	dim IGBT - TRIAC	€	151,00	
<i>With honeycomb</i>				
■ Led color	Nominal lm	▲ Beam spread		
2 = 2700°K	710	24°		
3 = 3000°K	760			

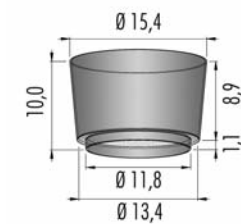

Housing for brickwork

● 1E00.100.01	€	25,00
---------------	---	-------

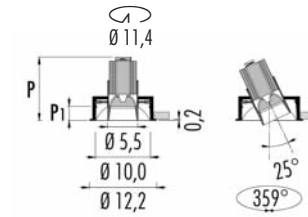

Frame	Color
02	Black
06	White
C1	Copper Anodized
S1	Brass Anodized

Available from 30/09/2019

easy Pop EX3		P	P1
3EX3.3■M.□	led IP40	10,5	0,5
3EX3.3■S.□	led IP40	11,4	2,5
3EX3.3■T.□	led IP40	9,4	0,5
4EX3.3■M.□	led IP40 + honeycomb	11,0	0,5
4EX3.3■S.□	led IP40 + honeycomb	11,9	2,5
4EX3.3■T.□	led IP40 + honeycomb	9,9	0,5
3EX3.3WM.□	led IP40	6,8	0,5
3EX3.3WS.□	led IP40	8,8	2,5
4EX3.3WM.□	led IP40 + honeycomb	7,3	0,5
4EX3.3WS.□	led IP40 + honeycomb	9,3	2,5

IP40		MC-E=3	CE	V	□
350m/A LED 11W CRI>90					
3EX3.3■M.□		€	145,00		
4EX3.3■M.□		€	151,00		
<i>With honeycomb</i>					
■ Led color	Nominal lm	▲ Beam spread			
2 = 2700°K	1195	M = 38°			
3 = 3000°K	1257	S = 22°			
4 = 4000°K	1313	T = 10°			

© (m-M) Driver		
3KIT.350.1L (1-1)	on/off	€ 21,00
3KIT.351.40 (1-3)	DALI - Push - 1...10V Remote installation	€ 105,00
3KIT.352.15 (1-1)	DALI	€ 59,00
3KIT.353.15 (1-1)	Push - 1...10V	€ 59,00
3KIT.354.18 (1-1)	IGBT - TRIAC	€ 32,00

Emergency unit: (inverter + battery. Driver not included)

3KIT.900.01 (1-1)	1:00 hour/ora	€ 95,00
3KIT.900.03 (1-1)	3:00 hours/ore	€ 137,00

IP40		DimToWarm	CE	V	□
220V ÷ 240V LED 6W CRI 95 Driver included					
3EX3.3W■.□	dim IGBT - TRIAC	€	200,00		
4EX3.3W■.□	dim IGBT - TRIAC	€	206,00		
<i>With honeycomb</i>					
■ Led color	Nominal lm	▲ Beam spread			
W= max 3000°K	max 445 lm	M = 30°			
min. 1800°K	min. 10 lm	S = 18°			

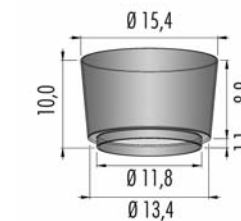

Housing for brickwork

● 1E00.100.01	€	25,00
---------------	---	-------

(m-M) = min. Led unit - Max Led unit.
Led and Emergency unit, warranty only when used together with driver bought from Oty srl.

easy Pop X3 NaNo Ø 10,0 with trim (for plasterboard and brickwork)

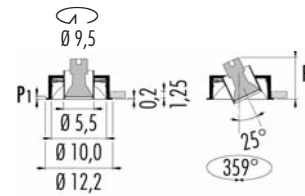

Frame	
02	Black
06	White
C1	Copper Anodized
S1	Brass Anodized

Available from 30/09/2019

easy NaNo Pop FX3		P	P ₁
3FX3.210.□	GU10	9,1	0,5
3FX3.211.□	GU10 led	—	0,5
4FX3.211.□	GU10 led + honeycomb	—	0,5
3FX3.K■S.□	led 9,5W IP40	10,0	0,5
4FX3.K■S.□	led 9,5W IP40 + honeycomb	10,5	0,5

IP20		CE	▽	□	
220V ÷ 240V					
3FX3.210.□	GU10 max 50W	€	120,00		
3FX3.211.□	GU10 led	€	120,00		
4FX3.211.□	GU10 led	€	126,00		
With honeycomb					
IP40		Flicker < 20%	CE	▽	□
220V ÷ 240V		LED 9,5W	CRI>90		
3FX3.K■S.□	dim IGBT - TRIAC	€	145,00		
4FX3.K■S.□	dim IGBT - TRIAC	€	151,00		
With honeycomb					
Led color	Nominal lm	Beam spread			
2 = 2700°K	710	24°			
3 = 3000°K	760				

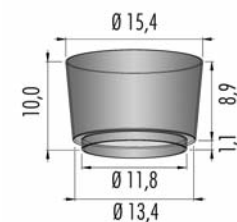

Housing for brickwork

● 1E00.100.01	€	25,00
---------------	---	-------

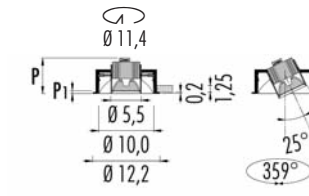

Frame	
02	Black
06	White
C1	Copper Anodized
S1	Brass Anodized

Available from 30/09/2019

easy NaNo Pop FX3		P	P ₁
3FX3.3■M.□	led IP40	7,8	0,5
3FX3.3■S.□	led IP40	6,8	0,5
3FX3.3■T.□	led IP40	6,8	0,5
4FX3.3■M.□	led IP40 + honeycomb	8,3	0,5
4FX3.3■S.□	led IP40 + honeycomb	7,3	0,5
4FX3.3■T.□	led IP40 + honeycomb	7,3	0,5

IP40		MC-E=3	CE	▽	□
250lm/A		LED 8W	CRI>90		
3FX3.3■M.□		€	145,00		
4FX3.3■M.□		€	151,00		
With honeycomb					
Led color	Nominal lm	Beam spread			
2 = 2700°K	779	M = 38°			
3 = 3000°K	819	S = 22°			
4 = 4000°K	855	T = 10°			

© (m-M) Driver

3KIT.250.1L (1-1)	on/off	€	21,00
3KIT.251.28 (1-3)	DALI - Push - 1...10V Remote installation	€	105,00
3KIT.252.12 (1-1)	DALI	€	59,00
3KIT.253.13 (1-1)	Push - 1...10V	€	59,00
3KIT.254.12 (1-1)	IGBT - TRIAC	€	32,00

Emergency unit: (inverter + battery. Driver not included)

3KIT.900.01 (1-1)	1:00 hour/ora	€	95,00
3KIT.900.03 (1-1)	3:00 hours/ore	€	137,00

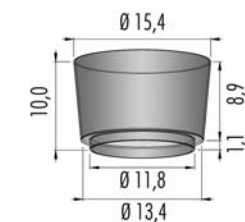

Housing for brickwork

● 1E00.100.01	€	25,00
---------------	---	-------

(m-M) = min. Led unit - Max Led unit.
Led and Emergency unit, warranty only when used
together with driver bought from Oty srl.

Pop Y3 Ø 10,0 trimless (only for plasterboard)

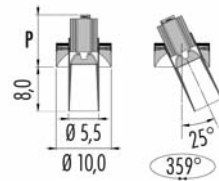
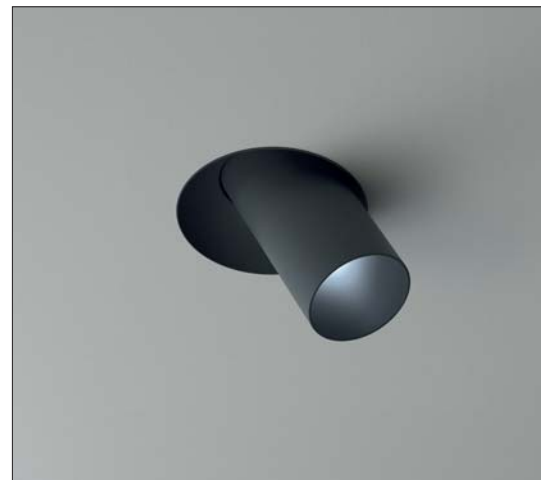

□	Frame
02	Black
06	White
C1	Copper Anodized
S1	Brass Anodized

Available from 30/09/2019

	Pop PY3	P
3PY3.210.□	GU10	9,1
3PY3.211.□	GU10 led	—
4PY3.211.□	GU10 led + honeycomb	—
3PY3.3.□	led IP40	9,4
4PY3.3.□	led IP40 + honeycomb	9,9
3PY3.3W.□	led IP40	6,1
4PY3.3W.□	led IP40 + honeycomb	6,6

(m-M) = min. Led unit - Max Led unit.
Led and Emergency unit, warranty only when used together with driver bought from Oty srl.

IP20	CE	▽	⊕
220V ÷ 240V			
3PY3.210.□	GU10 max 50W	€	95,00
3PY3.211.□	GU10 led	€	95,00
4PY3.211.□	GU10 led	€	101,00

With honeycomb

IP40	MC-E=3	CE	▽	⊕
350m/A	LED 11W	€	130,00	CRI>90
3PY3.3.□	S.□	€	136,00	
4PY3.3.□	S.□	€	136,00	

With honeycomb

■ Led color	Nominal lm	▲ Beam spread
2 = 2700°K	1195	20°
3 = 3000°K	1257	
4 = 4000°K	1313	

© (m-M) Driver		€
3KIT.350.1L (1-1)	on/off	21,00
3KIT.351.40 (1-3)	DALI - Push - 1...10V Remote installation	105,00
3KIT.352.15 (1-1)	DALI	59,00
3KIT.353.15 (1-1)	Push - 1...10V	59,00
3KIT.354.18 (1-1)	IGBT - TRIAC	32,00

Emergency unit: (inverter + battery. Driver not included)

3KIT.900.01 (1-1)	1:00 hour/ora	€	95,00
3KIT.900.03 (1-1)	3:00 hours/ore	€	137,00

IP40	DimToWarm	CE	▽	⊕
220V ÷ 240V	LED 6W CRI 95	€	170,00	Driver included
3PY3.3WS.□	dimm IGBT - TRIAC	€	176,00	
4PY3.3WS.□	dimm IGBT - TRIAC	€	176,00	

With honeycomb

■ Led color	Nominal lm	▲ Beam spread
W= max 3000°K min. 1800°K	max 445 lm min. 10 lm	20°

Housing for plasterboard

● 1Z00.100.01	⤵ Ø 11,4cm	€	45,00
---------------	------------	---	-------

Pop Y3 NaNo Ø 10,0 trimless (only for plasterboard)

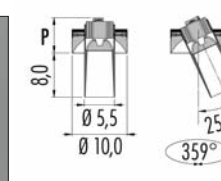
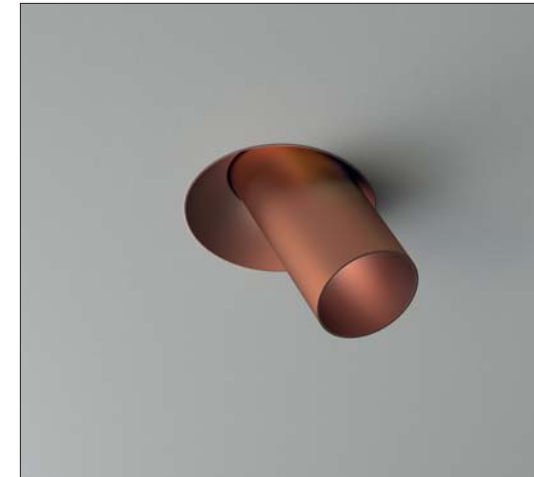

□	Frame
02	Black
06	White
C1	Copper Anodized
S1	Brass Anodized

Available from 30/09/2019

	Pop NY3	P
3NY3.3.□	led IP40	6,8
4NY3.3.□	led IP40 + honeycomb	7,3

(m-M) = min. Led unit - Max Led unit.
Led and Emergency unit, warranty only when used together with driver bought from Oty srl.

IP40	MC-E=3	CE	▽	⊕
250m/A	LED 8W	€	120,00	CRI>90
3NY3.3.□	S.□	€	126,00	
4NY3.3.□	S.□	€	126,00	

With honeycomb

■ Led color	Nominal lm	▲ Beam spread
2 = 2700°K	779	20°
3 = 3000°K	819	
4 = 4000°K	855	

© (m-M) Driver		€
3KIT.250.1L (1-1)	on/off	21,00
3KIT.251.28 (1-3)	DALI - Push - 1...10V Remote installation	105,00
3KIT.252.12 (1-1)	DALI	59,00
3KIT.253.13 (1-1)	Push - 1...10V	59,00
3KIT.254.12 (1-1)	IGBT - TRIAC	32,00

Emergency unit: (inverter + battery. Driver not included)

3KIT.900.01 (1-1)	1:00 hour/ora	€	95,00
3KIT.900.03 (1-1)	3:00 hours/ore	€	137,00

Housing for plasterboard

● 1Z00.100.01	⤵ Ø 11,4cm	€	45,00
---------------	------------	---	-------

easy Pop Y3 Ø 10,0 with trim (for plasterboard and brickwork)



IP40	DimToWarm	CE	MC-E=3
220V ÷ 240V	LED 6W CRI 95	Driver included	
3EY3.3WS.□	dim IGBT - TRIAC	€ 220,00	
4EY3.3WS.□	dim IGBT - TRIAC	€ 226,00	
<i>With honeycomb</i>			
■ Led color	Nominal lm	▲ Beam spread	
W = max 3000°K min. 1800°K	max 445 lm min. 10 lm	20°	

□	Frame
02	Black
06	White
C1	Copper Anodized
S1	Brass Anodized

Available from 30/09/2019

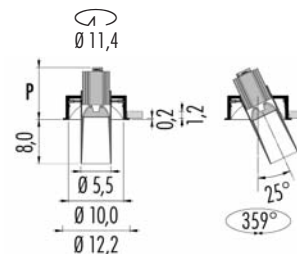

IP20	CE	MC-E=3
220V ÷ 240V		
3EY3.210.□	GU10 max 50W	€ 140,00
3EY3.211.□	GU10 led	€ 140,00
4EY3.211.□	GU10 led	€ 146,00
<i>With honeycomb</i>		

IP40	MC-E=3	CE
350m/A	LED 11W	CRI>90
3EY3.3.□		€ 165,00
4EY3.3.□		€ 171,00
<i>With honeycomb</i>		

■ Led color	Nominal lm	▲ Beam spread
2 = 2700°K	1195	20°
3 = 3000°K	1257	
4 = 4000°K	1313	

© (m-M)	Driver	Price
3KIT.350.1L (1-1)	on/off	€ 21,00
3KIT.351.40 (1-3)	DALI - Push - 1...10V Remote installation	€ 105,00
3KIT.352.15 (1-1)	DALI	€ 59,00
3KIT.353.15 (1-1)	Push - 1...10V	€ 59,00
3KIT.354.18 (1-1)	IGBT - TRIAC	€ 32,00

Emergency unit: (inverter + battery. Driver not included)

3KIT.900.01 (1-1)	1:00 hour/ora	€ 95,00
3KIT.900.03 (1-1)	3:00 hours/ore	€ 137,00

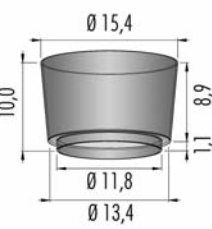

Housing for brickwork

● 1E00.100.01	€ 25,00
---------------	---------

(m-M) = min. Led unit - Max Led unit.
Led and Emergency unit, warranty only when used
together with driver bought from Oty srl.

easy Pop Y3 NaNo Ø 10,0 with trim (for plasterboard and brickwork)



□	Frame
02	Black
06	White
C1	Copper Anodized
S1	Brass Anodized

Available from 30/09/2019

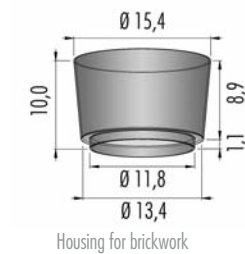
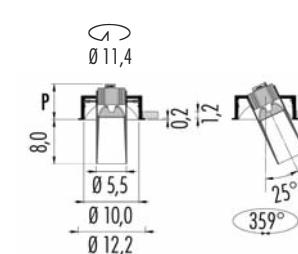

Housing for brickwork

● 1E00.100.01	€ 25,00
---------------	---------

(m-M) = min. Led unit - Max Led unit.
Led and Emergency unit, warranty only when used
together with driver bought from Oty srl.

IP40	MC-E=3	CE
250m/A	LED 8W	CRI>90
3FY3.3.□		€ 165,00
4FY3.3.□		€ 171,00
<i>With honeycomb</i>		
■ Led color	Nominal lm	▲ Beam spread
2 = 2700°K	779	20°
3 = 3000°K	879	
4 = 4000°K	855	

© (m-M)	Driver	Price
3KIT.250.1L (1-1)	on/off	€ 21,00
3KIT.251.28 (1-3)	DALI - Push - 1...10V Remote installation	€ 105,00
3KIT.252.12 (1-1)	DALI	€ 59,00
3KIT.253.13 (1-1)	Push - 1...10V	€ 59,00
3KIT.254.12 (1-1)	IGBT - TRIAC	€ 32,00

Emergency unit: (inverter + battery. Driver not included)

3KIT.900.01 (1-1)	1:00 hour/ora	€ 95,00
3KIT.900.03 (1-1)	3:00 hours/ore	€ 137,00

Pop Y3 Ø 10,0 trimless, Glass (only for plasterboard)

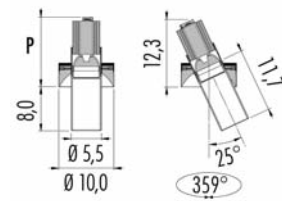

	Frame	Glass
02F	Black	Fumé
06T	White	Transparent
C1F	Copper Anodized	Fumé
S1C	Brass Anodized	Champagne

Available from 30/09/2019

	Pop PY3	P
3PY3.210.□	GU10	12,0
3PY3.211.□	GU10 led	—
4PY3.211.□	GU10 led + honeycomb	—
3PY3.220.□	GU5.3	10,4
4PY3.220.□	GU5.3 led + honeycomb	—
3PY3.3.□	led IP40	12,6
4PY3.3.□	led IP40 + honeycomb	13,1
3PY3.3W.□	led IP40	6,1
4PY3.3W.□	led IP40 + honeycomb	6,6

(m-M) = min. Led unit - Max Led unit.
Led and Emergency unit, warranty only when used together with driver bought from Oty srl.

IP20	MC-E=3	CE	▽	⊕
220V ÷ 240V				
3PY3.211.□	GU10 led ONLY	€	120,00	
4PY3.211.□	GU10 led ONLY	€	126,00	
With honeycomb				

IP40	MC-E=3	CE	▽	⊕
350m/A	LED 11W	CRI>90		
3PY3.3.□		€	145,00	
4PY3.3.□		€	151,00	
With honeycomb				

■ Led color	Nominal lm	▲ Beam spread
2 = 2700°K	1195	S = 22°
3 = 3000°K	1257	T = 12°
4 = 4000°K	1313	

© (m-M)	Driver		€
3KIT.350.1L (1-1)	on/off		21,00
3KIT.351.40 (1-3)	DALI - Push - 1...10V Remote installation		105,00
3KIT.352.15 (1-1)	DALI		59,00
3KIT.353.15 (1-1)	Push - 1...10V		59,00
3KIT.354.18 (1-1)	IGBT - TRIAC		32,00

Emergency unit: (inverter + battery. Driver not included)

3KIT.900.01 (1-1)	1:00 hour/ora	€	95,00
3KIT.900.03 (1-1)	3:00 hours/ore	€	137,00

IP40	DimToWarm	CE	▽	⊕
220V ÷ 240V	LED 6W	CRI 95		Driver incluso
3PY3.3W.□	dimmi IGBT - TRIAC	€	190,00	
4PY3.3W.□	dimmi IGBT - TRIAC	€	196,00	
With honeycomb				

■ Led color	Nominal lm	▲ Beam spread
W= max 3000°K min. 1800°K	max 445 lm min. 10 lm	M = 30° S = 18°

Housing for plasterboard

● 1Z00.100.01	⤵ Ø 11,4cm	€	45,00
---------------	------------	---	-------

Pop Y3 NaNo Ø 10,0 trimless, Glass (only for plasterboard)

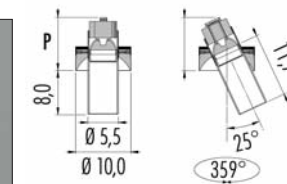

	Frame	Glass
02F	Black	Fumé
06T	White	Transparent
C1F	Copper Anodized	Fumé
S1C	Brass Anodized	Champagne

Available from 30/09/2019

	Pop NaNo NY3	P
3NY3.3.□	led IP40	9,7
4NY3.3.□	led IP40 + honeycomb	10,2

(m-M) = min. Led unit - Max Led unit.
Led and Emergency unit, warranty only when used together with driver bought from Oty srl.

IP40	MC-E=3	CE	▽	⊕
250m/A	LED 8W	CRI>90		
3NY3.3.□		€	140,00	
4NY3.3.□		€	146,00	
With honeycomb				
■ Led color	Nominal lm	▲ Beam spread		
2 = 2700°K	779	S = 22°		
3 = 3000°K	879	T = 12°		
4 = 4000°K	855			

© (m-M)	Driver		€
3KIT.250.1L (1-1)	on/off		21,00
3KIT.251.28 (1-3)	DALI - Push - 1...10V Remote installation		105,00
3KIT.252.12 (1-1)	DALI		59,00
3KIT.253.13 (1-1)	Push - 1...10V		59,00
3KIT.254.12 (1-1)	IGBT - TRIAC		32,00

Emergency unit: (inverter + battery. Driver not included)

3KIT.900.01 (1-1)	1:00 hour/ora	€	95,00
3KIT.900.03 (1-1)	3:00 hours/ore	€	137,00

Housing for plasterboard

● 1Z00.100.01	⤵ Ø 11,4cm	€	45,00
---------------	------------	---	-------

easy Pop Y3 Ø 10,0 with trim, Glass (for plasterboard and brickwork)



IP40	DimToWarm	CE	V	⚡
220V ÷ 240V	LED 6W CRI 95	Driver incluso		
3EY3.3W	dimmm IGBT - TRIAC	€	235,00	
4EY3.3W	dimmm IGBT - TRIAC	€	241,00	
With honeycomb				

Led color	Nominal lm	Beam spread
W = max 3000°K min. 1800°K	max 445 lm min. 10 lm	M = 30° S = 18°

Frame	Glass
02F Black	Fumé
06T White	Transparent
C1F Copper Anodized	Fumé
S1C Brass Anodized	Champagne

Available from 30/09/2019

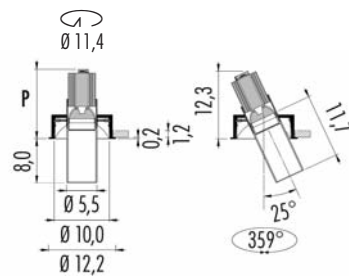

IP20	CE	V	⚡
220V ÷ 240V			
3EY3.211	GU10 led ONLY	€	160,00
4EY3.211	GU10 led ONLY	€	166,00
With honeycomb			

IP40	MC-E=3	CE	V	⚡
350m/A	LED 11W	CRI>90		
3EY3.3		€	185,00	
4EY3.3		€	191,00	
With honeycomb				

Led color	Nominal lm	Beam spread
2 = 2700°K 3 = 3000°K 4 = 4000°K	1195 1257 1313	S = 22° T = 12°

(m-M)	Driver	Price
3KIT.350.1L (1-1)	on/off	€ 21,00
3KIT.351.40 (1-3)	DALI - Push - 1...10V Remote installation	€ 105,00
3KIT.352.15 (1-1)	DALI	€ 59,00
3KIT.353.15 (1-1)	Push - 1...10V	€ 59,00
3KIT.354.18 (1-1)	IGBT - TRIAC	€ 32,00

Emergency unit: (inverter + battery. Driver not included)

3KIT.900.01 (1-1)	1:00 hour/ora	€ 95,00
3KIT.900.03 (1-1)	3:00 hours/ore	€ 137,00

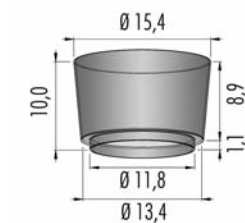

Housing for brickwork

1E00.100.01	€ 25,00
-------------	---------

easy Pop EY3	P
3EY3.210	GU10 9,1
3EY3.211	GU10 led —
4EY3.211	GU10 led + honeycomb —
3EY3.3	led IP40 9,4
4EY3.3	led IP40 + honeycomb 9,9
3EY3.3W	led IP40 6,1
4EY3.3W	led IP40 + honeycomb 6,6

(m-M) = min. Led unit - Max Led unit.
Led and Emergency unit, warranty only when used
together with driver bought from Oty srl.

easy Pop Y3 NaNo Ø 10,0 with trim, Glass (for plasterboard and brickwork)



Frame	Glass
02F Black	Fumé
06T White	Transparent
C1F Copper Anodized	Fumé
S1C Brass Anodized	Champagne

Available from 30/09/2019

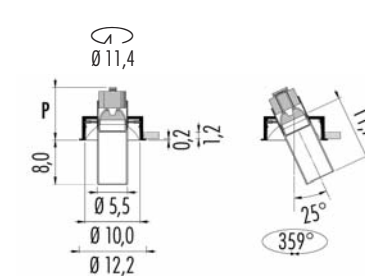

easy Pop NaNo FY3	P
3FY3.3	led IP40 9,7
4FY3.3	led IP40 + honeycomb 10,2

IP40	MC-E=3	CE	V	⚡
250m/A	LED 8W	CRI>90		
3FY3.3		€	185,00	
4FY3.3		€	191,00	
With honeycomb				

Led color	Nominal lm	Beam spread
2 = 2700°K 3 = 3000°K 4 = 4000°K	779 879 855	S = 22° T = 12°

(m-M)	Driver	Price
3KIT.250.1L (1-1)	on/off	€ 21,00
3KIT.251.28 (1-3)	DALI - Push - 1...10V Remote installation	€ 105,00
3KIT.252.12 (1-1)	DALI	€ 59,00
3KIT.253.13 (1-1)	Push - 1...10V	€ 59,00
3KIT.254.12 (1-1)	IGBT - TRIAC	€ 32,00

Emergency unit: (inverter + battery. Driver not included)

3KIT.900.01 (1-1)	1:00 hour/ora	€ 95,00
3KIT.900.03 (1-1)	3:00 hours/ore	€ 137,00

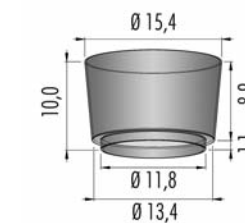

Housing for brickwork

1E00.100.01	€ 25,00
-------------	---------

(m-M) = min. Led unit - Max Led unit.
Led and Emergency unit, warranty only when used
together with driver bought from Oty srl.

Pop Z3 Ø 10,0 trimless (only for plasterboard)

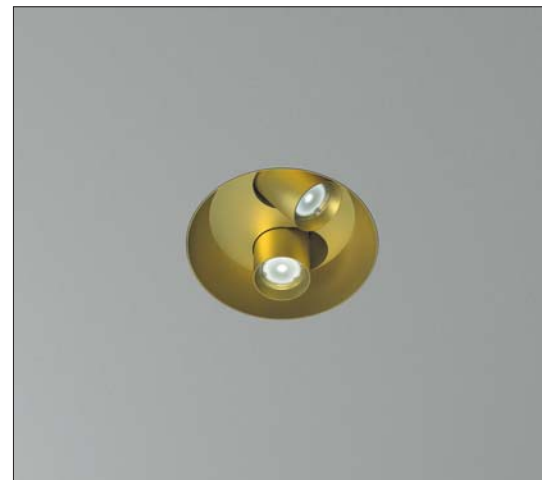

□	Frame
02 ●	Black
06 ○	White
C1 ●	Copper Anodized
S1 ●	Brass Anodized

Available from 30/09/2019

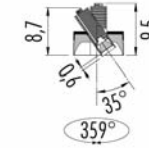

IP40	MC-E=3	CE
500m/A	LED 2x6W	CRI>90
3PZ3.2	M. □	€ 230,00
■ Led color	Nominal lm	▲ Beam spread
2 = 2700 °K	2x528	25°
3 = 3000 °K	2x552	

© (to order) Driver

3KIT.500.15 (n° 2) on/off	€ 27,00
3KIT.501.50 (n° 1) DALI - Push - 1...10V	€ 105,00
3KIT.502.20 (n° 1) DALI	€ 59,00
3KIT.503.20 (n° 1) Push - 1...10	€ 59,00
3KIT.504.10 (n° 2) IGBT - TRIAC	€ 32,00

Emergency unit: (inverter + battery. Driver not included)

3KIT.900.01 (1-1) 1:00 hour/ora	€ 95,00
3KIT.900.03 (1-1) 3:00 hours/ore	€ 137,00

Housing for plasterboard

● 1Z00.100.01	Ø 11,4cm	€ 45,00
---------------	----------	---------

(m-M) = min. Led unit - Max Led unit.
Led and Emergency unit, warranty only when used
together with driver bought from Oty srl.

easy Pop Z3 $\varnothing 10,0$ with trim (for plasterboard and brickwork)



□	Frame
02	Black
06	White
C1	Copper Anodized
S1	Brass Anodized

Available from 30/09/2019

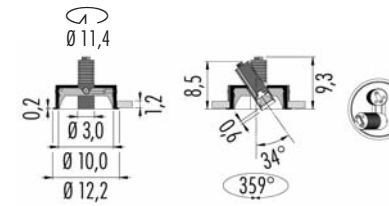

IP40	MC-E-3	CE
500m/A	LED 2x6W	CRI>90
3EZ3.2	M. □	€ 280,00
■ Led color	Nominal lm	▲ Beam spread
2 = 2700 °K	2x528	25°
3 = 3000 °K	2x552	

© (to order) Driver

3KIT.500.15	(n° 2) on/off	€ 27,00
3KIT.501.50	(n° 1) DALI - Push - 1...10V	€ 105,00
3KIT.502.20	(n° 1) DALI	€ 59,00
3KIT.503.20	(n° 1) Push - 1...10	€ 59,00
3KIT.504.10	(n° 2) IGBT - TRIAC	€ 32,00

Emergency unit: (inverter + battery. Driver not included)

3KIT.900.01	(1-1) 1:00 hour/ora	€ 95,00
3KIT.900.03	(1-1) 3:00 hours/ore	€ 137,00

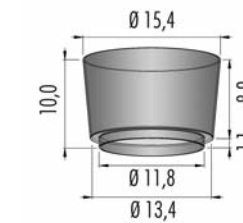

Housing for brickwork

● 1E00.100.01	€ 25,00
---------------	---------

(m-M) = min. Led unit - Max Led unit.
Led and Emergency unit, warranty only when used
together with driver bought from Oty srl.

Pop 03 \varnothing 17,0 trimless (for plasterboard and brickwork)



□ Frame

02 ● Black

06 ○ White

IP20	CE	▼	⊕
12V			
3P03.530.□	653 max 50W	€	164,00
3KIT.201.050	max 50VA	€	32,00
Dimmable gear: IGBT			

Housing for plasterboard ↻ \varnothing 19,0 cm			
●	1Z00.170.01	Single	€ 57,00
●●	1Z00.170.2L	Double	€ 111,00
●●●	1Z00.170.3L	Triple <small>ROS</small>	€ 161,00
Housing for brickwork			
●	1M00.170.01		€ 148,00

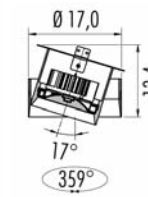
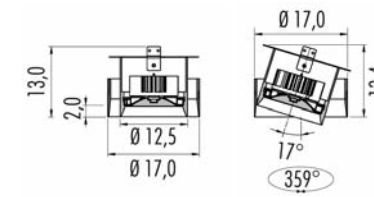

IP20	MC-E-3	CE	▼	⊕
350 - 500 - 700 m/A		CRI>90		
3P03.6		€	273,00	
© (m-M) LED 12,5W 350m/A				
3KIT.350.1L (1-1)	on/off	€	21,00	
3KIT.351.40 (1-3)	DALI - Push - 1...10V	€	105,00	
3KIT.352.15 (1-1)	DALI	€	59,00	
3KIT.353.15 (1-1)	Push - 1...10V	€	59,00	
3KIT.354.18 (1-1)	IGBT - TRIAC	€	32,00	
■ Led color	Nominal lm	▲ Beam spread		
2 = 2700 °K	1477	L = 60°		
3 = 3000 °K	1565	S = 24°		
4 = 4000 °K	1635	T = 12°		
© (m-M) LED 18,4W 500m/A				
3KIT.500.1L (1-1)	on/off	€	21,00	
3KIT.501.50 (1-3)	DALI - Push - 1...10V	€	105,00	
3KIT.502.20 (1-1)	DALI	€	59,00	
3KIT.503.20 (1-1)	Push - 1...10V	€	59,00	
3KIT.504.20 (1-1)	IGBT - TRIAC	€	32,00	
■ Led color	Nominal lm	▲ Beam spread		
2 = 2700 °K	2020	L = 60°		
3 = 3000 °K	2140	S = 24°		
4 = 4000 °K	2236	T = 12°		
© (m-M) LED 27W 700m/A				
3KIT.700.1L (1-1)	on/off	€	24,00	
3KIT.701.50 (1-1)	DALI - Push - 1...10V	€	105,00	
■ Led color	Nominal lm	▲ Beam spread		
2 = 2700 °K	2683	L = 60°		
3 = 3000 °K	2842	S = 24°		
4 = 4000 °K	2963	T = 12°		
Emergency unit: (inverter + battery. Driver not included)				
3KIT.900.01 (1-1)	1:00 hour/ora	€	95,00	
3KIT.900.03 (1-1)	3:00 hours/ore	€	137,00	

(m-M) = min. Led unit - Max Led unit.
Led and Emergency unit, warranty only when used together with driver bought from Oty srl.

Pop 03 Static Ø 17,0 trimless (for plasterboard and brickwork)



□ Frame

02 ● Black
06 ○ White

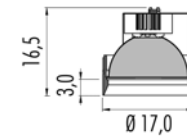

IP40	MC-E=3	CE	▽	⊕
700m/A	LED 26W	CRI>90		
3P03S.6	L.□	€ 241,00		
■ Led color	Nominal lm	▲ Beam spread		
2 = 2700°K	3374	80°		
3 = 3000°K	3533			
4 = 4000°K	3649			

© (m-M) Driver 700m/A

3KIT.700.1L (1-1)	on/off	€ 24,00
3KIT.701.50 (1-1)	DALI - Push - 1...10V	€ 105,00

Emergency unit: (inverter + battery. Driver not included)

3KIT.900.01 (1-1)	1:00 hour/ora	€ 95,00
3KIT.900.03 (1-1)	3:00 hours/ore	€ 137,00

Housing for plasterboard ↻ Ø 19,0 cm

● 1Z00.170.01	Single	€ 57,00
---------------	--------	---------

Housing for brickwork

● 1M00.170.01		€ 148,00
---------------	--	----------

(m-M) = min. Led unit - Max Led unit.
Led and Emergency unit, warranty only when used
together with driver bought from Oty srl.

Pop 03 Wall Wash Ø 17,0 cm ROS

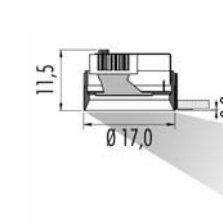

□ Frame

02 ● Black
06 ○ White

IP40	MC-E=3	CE	▽	⊕
700m/A	LED 26W	CRI>90		
3P03S.6	W.□	€ 210,00	▼	
■ Led color	Nominal lm	▲ Beam spread		
2 = 2700°K	3374	W = wall wash		
3 = 3000°K	3533			
4 = 4000°K	3649			

© (m-M) Driver 700m/A

3KIT.700.1L (1-1)	on/off	€ 24,00
3KIT.701.50 (1-1)	DALI - Push - 1...10V	€ 105,00

Emergency unit: (inverter + battery. Driver not included)

3KIT.900.01 (1-1)	1:00 hour/ora	€ 95,00
3KIT.900.03 (1-1)	3:00 hours/ore	€ 137,00

Housing for plasterboard ↻ Ø 19,0 cm

● 1Z00.170.01	Single	€ 57,00
---------------	--------	---------

Housing for brickwork

● 1M00.170.01		€ 148,00
---------------	--	----------

(m-M) = min. Led unit - Max Led unit.
Led and Emergency unit, warranty only when used
together with driver bought from Oty srl.

Pop 03 Look Ø 17,0 trimless (only for plasterboard)



- Frame
 02 ● Black
 06 ○ White

Free of Tax

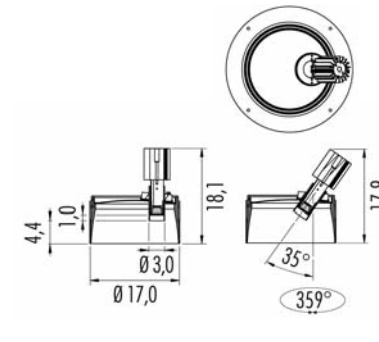

Look x1

IP40	MC-E=3	CE	▽	⊕
350m/A	LED 1x13,4W	CRI>90		
3PL31.2 M.□		€ 193,00		
4PL31.2 M.□		€ 199,00		
<i>With honeycomb</i>				

Led color	Nominal lm	Beam spread
2 = 2700°K	1650	37°
3 = 3000°K	1727	
4 = 4000°K	1786	

©	Driver	
3KIT.350.1L (n° 1)	on/off	€ 21,00
3KIT.352.15 (n° 1)	DALI	€ 59,00
3KIT.353.15 (n° 1)	Push - 1...10V	€ 59,00
3KIT.354.18 (n° 1)	IGBT - TRIAC	€ 32,00

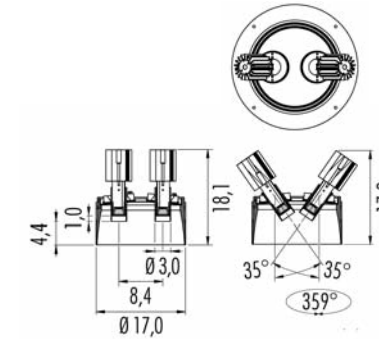

Look x2

IP40	MC-E=3	CE	▽	⊕
350m/A	LED 2x13,4W	CRI>90		
3PL32.2 M.□		€ 289,00		
4PL32.2 M.□		€ 301,00		
<i>With honeycomb</i>				

Led color	Nominal lm	Beam spread
2 = 2700°K	2x1650	37°
3 = 3000°K	2x1727	
4 = 4000°K	2x1786	

©	Driver	
3KIT.350.1L (n° 2)	on/off	€ 21,00
3KIT.351.40 (n° 1)	DALI - Push - 1...10V	€ 105,00
3KIT.354.18 (n° 2)	IGBT - Triac	€ 32,00

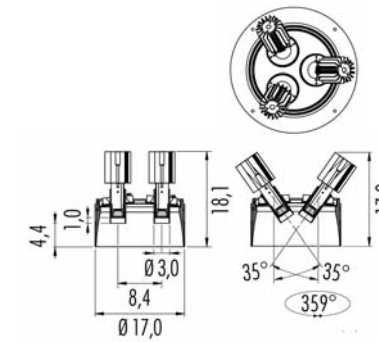

Look x3

IP40	MC-E=3	CE	▽	⊕
350m/A	LED 3x13,4W	CRI>90		
3PL33.2 M.□		€ 386,00		
4PL33.2 M.□		€ 404,00		
<i>With honeycomb</i>				

Led color	Nominal lm	Beam spread
2 = 2700°K	3x1650	37°
3 = 3000°K	3x1727	
4 = 4000°K	3x1786	

©	Driver	
3KIT.350.1L (n° 3)	on/off	€ 21,00
3KIT.352.15 (n° 3)	DALI	€ 59,00
3KIT.353.15 (n° 3)	Push - 1...10V	€ 59,00
3KIT.354.18 (n° 3)	IGBT - Triac	€ 32,00

Housing for plasterboard

- 1K00.170.01 ⌀ 19,0 cm € 64,00

(m-M) = min. Led unit - Max Led unit.
 Led and Emergency unit, warranty only when used
 together with driver bought from Oty srl.

Pop 04 \varnothing 8,0 trimless (for plasterboard and brickwork)

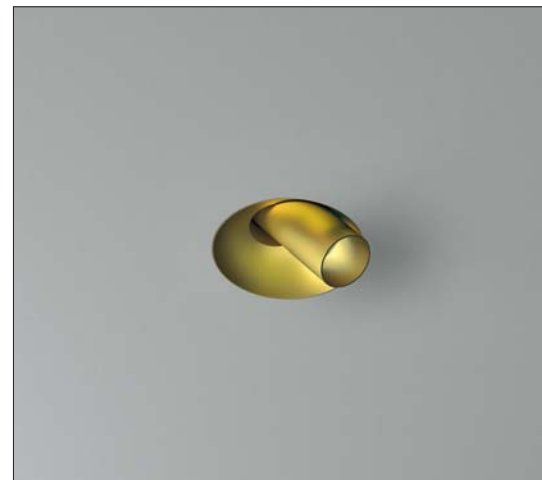
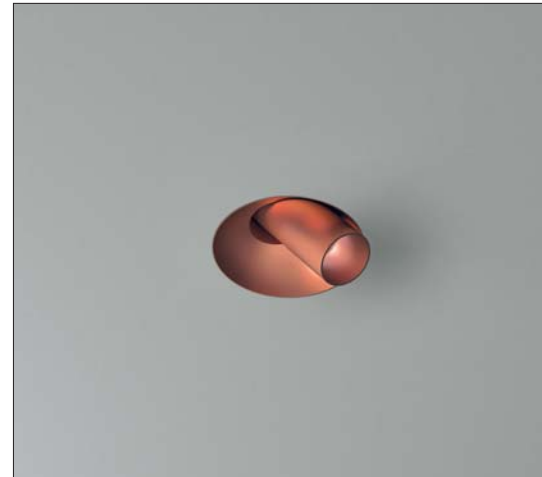

	Frame
02	Black
06	White
C1	Copper Anodized
S1	Brass Anodized

Finishes C1 and S1 are available from 30/09/2019

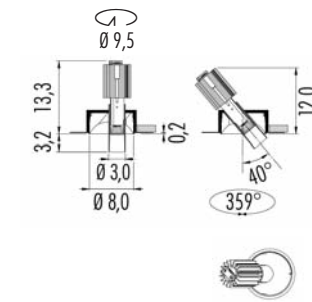

IP40	CE	V	⊕
350m/A	LED 13,4W	CRI>90	
3P04.2	S.□	€ 118,00	
4P04.2	S.□	€ 124,00	
With honeycomb			
■ Led color	Nominal lm	▲ Beam spread	
2 = 2700°K	1650	25°	
3 = 3000°K	1727		
4 = 4000°K	1786		

© (m-M) Driver

3KIT.350.1L (1-1)	on/off	€ 21,00
3KIT.351.40 (1-2)	DALI - Push - 1...10V Remote installation	€ 105,00
3KIT.352.15 (1-1)	DALI	€ 59,00
3KIT.353.15 (1-1)	Push - 1...10V	€ 59,00
3KIT.354.18 (1-1)	IGBT - TRIAC	€ 32,00

Emergency unit: (inverter + battery. Driver not included)

3KIT.900.01 (1-1)	1:00 hour/ora	€ 95,00
3KIT.900.03 (1-1)	3:00 hours/ore	€ 137,00

Housing for plasterboard \varnothing 9,5cm

●	1Z00.080.01	Single	€ 33,00
●●	1Z00.080.2L	Double	€ 61,00
●●●	1Z00.080.3L	Triple	€ 89,00

easy Pop 04 \varnothing 8,0 with trim (for plasterboard and brickwork)



□	Frame
02	Black
06	White
C1	Copper Anodized
S1	Brass Anodized

Finishes C1 and S1 are available from 30/09/2019

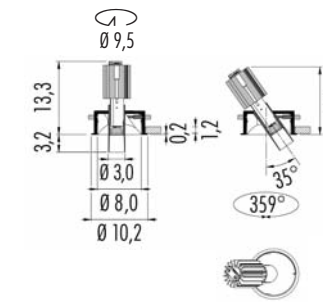

IP40	CE	V	⊕
350m/A	LED 13,4W	CRI>90	
3E04.2	□	€ 145,00	
4E04.2	□	€ 151,00	
With honeycomb			
■ Led color	Nominal lm	▲ Beam spread	
2 = 2700°K	1650	25°	
3 = 3000°K	1727		
4 = 4000°K	1786		

© (m-M) Driver

3KIT.350.1L (1-1)	on/off	€ 21,00
3KIT.351.40 (1-2)	DALI - Push - 1...10V Remote installation	€ 105,00
3KIT.352.15 (1-1)	DALI	€ 59,00
3KIT.353.15 (1-1)	Push - 1...10V	€ 59,00
3KIT.354.18 (1-1)	IGBT - TRIAC	€ 32,00

Emergency unit: (inverter + battery. Driver not included)

3KIT.900.01 (1-1)	1:00 hour/ora	€ 95,00
3KIT.900.03 (1-1)	3:00 hours/ore	€ 137,00

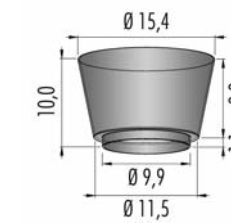

Housing for brickwork

● 1E00.080.01	€ 25,00
---------------	---------

(m-M) = min. Led unit - Max Led unit.
Led and Emergency unit, warranty only when used together with driver bought from Oty srl.

Pop 04 Ø 12,0 trimless (for plasterboard and brickwork)

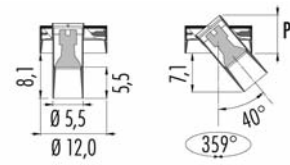

IP20	CE	V	□
220V ÷ 240V			
3P04.210.□	GU10	max 50W	€ 98,00
3P04.211.□	GU10	led	€ 98,00
4P04.211.□	GU10	led	€ 104,00
With honeycomb			

IP20	CE	V	⊕
12V			
3P04.220.□	GU5.3	max 50W	€ 90,00
4P04.220.□	GU5.3	led	€ 96,00
With honeycomb			
3KIT.201.050		max 50VA	€ 32,00

Housing for plasterboard ↻ Ø 14,0cm			
●	1Z00.120.01	Single	€ 46,00
●●	1Z00.120.2L	Double	€ 88,00
●●●	1Z00.120.3L	Triple <i>ROS</i>	€ 125,00

Housing for brickwork			
●	1M00.120.01		€ 111,00

□	Frame
02 ●	Black
06 ○	White

Pop P04	P	
3P04.210.□	GU10	8,4
3P04.211.□	GU10 led	—
4P04.211.□	GU10 led + honeycomb	—
3P04.220.□	GU5.3	6,8
4P04.220.□	GU5.3 led + honeycomb	—

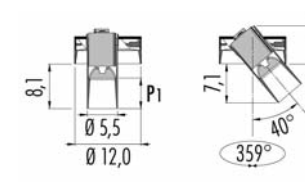

IP40	MC-E=3	CE	V	⊕
350m/A	LED 11W			
3P04.3	■▲▲	□	CRI>90	€ 185,00
4P04.3	■▲▲	□		€ 191,00
With honeycomb				

Led color	Nominal lm	▲ Beam spread
2 = 2700°K	1195	M = 38°
3 = 3000°K	1257	S = 22°
4 = 4000°K	1313	T = 12°

© (m-M)	Driver	
3KIT.350.1L (1-1)	on/off	€ 21,00
3KIT.351.40 (1-3)	DALI - Push - 1...10V Remote installation	€ 105,00
3KIT.352.15 (1-1)	DALI	€ 59,00
3KIT.353.15 (1-1)	Push - 1...10V	€ 59,00
3KIT.354.18 (1-1)	IGBT - TRIAC	€ 32,00
Emergency unit: (inverter + battery. Driver not included)		
3KIT.900.01 (1-1)	1:00 hour/ora	€ 95,00
3KIT.900.03 (1-1)	3:00 hours/ore	€ 137,00

Housing for plasterboard ↻ Ø 14,0cm			
●	1Z00.120.01	Single	€ 46,00
●●	1Z00.120.2L	Double	€ 88,00
●●●	1Z00.120.3L	Triple <i>ROS</i>	€ 125,00

Housing for brickwork			
●	1M00.120.01		€ 111,00

Pop P04	P	P1
3P04.3 ■ M. □ led IP40	6,8	2,5
3P04.3 ■ S. □ led IP40	6,8	5,5
3P04.3 ■ T. □ led IP40	6,8	2,5
4P04.3 ■ M. □ led IP40 + honeycomb	6,8	2,5
4P04.3 ■ S. □ led IP40 + honeycomb	7,4	5,5
4P04.3 ■ T. □ led IP40 + honeycomb	6,8	2,5

Pop 04A Magic Ø 3,0 (only for plasterboard)

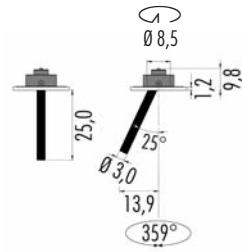

IP40	CE	V	⚡
350m/A	LED 13,4W	CRI>85	
3P04A.2	M. □	€ 225,00	
4P04A.2	M. □	€ 231,00	
<i>With honeycomb</i>			
■ Led color	Nominal lm	▲ Beam spread	
2 = 2700 °K	1650	35°	
3 = 3000 °K	1727		
4 = 4000 °K	1786		

© (m-M)	Driver	
3KIT.350.1L (1-1)	on/off	€ 21,00
3KIT.351.40 (1-2)	DALI - Push - 1...10V Remote installation	€ 105,00
3KIT.352.15 (1-1)	DALI	€ 59,00
3KIT.353.15 (1-1)	Push - 1...10V	€ 59,00
3KIT.354.18 (1-1)	IGBT - TRIAC	€ 32,00

Emergency unit: (inverter + battery. Driver not included)

3KIT.900.01 (1-1)	1:00 hour/ora	€ 95,00
3KIT.900.03 (1-1)	3:00 hours/ore	€ 137,00

□ Frame

- 02 ● Black
06 ○ White

Housing for plasterboard

- 1W00.085.01 € 107,00

(m-M) = min. Led unit - Max Led unit.
Led and Emergency unit, warranty only when used
together with driver bought from Oty srl.

Pop 04B Magic Ø 3,0 (only for plasterboard)

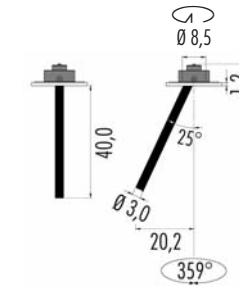

IP40	CE	V	⚡
350m/A	LED 13,4W	CRI>85	
3P04B.2	M. □	€ 231,00	
4P04B.2	M. □	€ 237,00	
<i>With honeycomb</i>			
■ Led color	Nominal lm	▲ Beam spread	
2 = 2700 °K	1650	35°	
3 = 3000 °K	1727		
4 = 4000 °K	1786		

© (m-M)	Driver	
3KIT.350.1L (1-1)	on/off	€ 21,00
3KIT.351.40 (1-2)	DALI - Push - 1...10V Remote installation	€ 105,00
3KIT.352.15 (1-1)	DALI	€ 59,00
3KIT.353.15 (1-1)	Push - 1...10V	€ 59,00
3KIT.354.18 (1-1)	IGBT - TRIAC	€ 32,00

Emergency unit: (inverter + battery. Driver not included)

3KIT.900.01 (1-1)	1:00 hour/ora	€ 95,00
3KIT.900.03 (1-1)	3:00 hours/ore	€ 137,00

□ Frame

- 02 ● Black
06 ○ White

Housing for plasterboard

- 1W00.085.01 € 107,00

(m-M) = min. Led unit - Max Led unit.
Led and Emergency unit, warranty only when used
together with driver bought from Oty srl.

Pop 04C Magic Ø 3,0 (only for plasterboard)



□ Frame

02 ● Black
06 ○ White

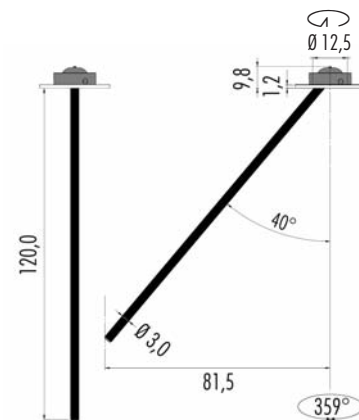

IP40		CE	▼	⊕
350m/A	LED 13,4W	CRI>85		
3P04C.2	M. □	€ 386,00		
4P04C.2	M. □	€ 392,00		
<i>With honeycomb</i>				
Led color	Nominal lm	▲ Beam spread		
2 = 2700°K	1650	35°		
3 = 3000°K	1727			
4 = 4000°K	1786			
© (m-M) Driver				
3KIT.350.1L (1-1)	on/off	€ 21,00		
3KIT.351.40 (1-2)	DALI - Push - 1...10V Remote installation	€ 105,00		
3KIT.352.15 (1-1)	DALI	€ 59,00		
3KIT.353.15 (1-1)	Push - 1...10V	€ 59,00		
3KIT.354.18 (1-1)	IGBT - TRIAC	€ 32,00		
Emergency unit: (inverter + battery. Driver not included)				
3KIT.900.01 (1-1)	1:00 hour	€ 95,00		
3KIT.900.03 (1-1)	3:00 hours	€ 137,00		

Housing for plasterboard

- 1W00.125.01 € 134,00

(m-M) = min. Led unit - Max Led unit.
Led and Emergency unit, warranty only when used
together with driver bought from Oty srl.

Pop 04K Magic Ø 3,0 ceiling



□ Frame

02 ● Black
06 ○ White

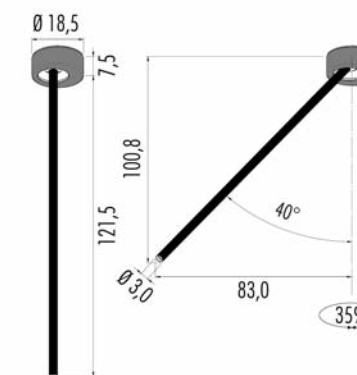

IP40		CE	▼	⊕
220-240V	LED 13,4W	CRI>90		
3P04K.2	M. □ dimm. IGBT - TRIAC	€ 550,00		
4P04K.2	M. □ dimm. IGBT - TRIAC	€ 556,00		
<i>With honeycomb</i>				
3P04KA2	M. □ DALI	€ 566,00		
4P04KA2	M. □ DALI	€ 572,00		
<i>With honeycomb</i>				
3P04KG2	M. □ Push - 1...10V	€ 566,00		
4P04KG2	M. □ Push - 1...10V	€ 572,00		
<i>With honeycomb</i>				
Led color	Nominal lm	▲ Beam spread		
2 = 2700°K	1650	35°		
3 = 3000°K	1727			
4 = 4000°K	1786			

(m-M) = min. Led unit - Max Led unit.
Led and Emergency unit, warranty only when used
together with driver bought from Oty srl.

Pop 05 Ø 6,7 (only for brickwork) 

- Frame
- 02 ● Black
- 06 ○ White

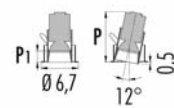

	Pop P05	P	P1
3P05.200.□	GU4	8,5	2,5
3P05.2□ S.□	led	11,6	3,7

IP20	CE	V	⊕
12V			
3P05.200.□	GU4	max 35W	€ 49,00
3KIT.201.050		max 50VA	€ 32,00
Dimmable gear: IGBT			

IP40	CE	V	⊕
350m/A	LED 11W	CRI>90	
3P05.2□ S.□			€ 97,00
■ Led color	Nominal lm	▲ Beam spread	
2 = 2700°K	1195	22°	
3 = 3000°K	1257		
4 = 4000°K	1313		

© (m-M)	Driver	
3KIT.350.1L (1-1)	on/off	€ 21,00
3KIT.351.40 (1-3)	DALI - Push - 1...10V Remote installation	€ 105,00
3KIT.352.15 (1-1)	DALI	€ 59,00
3KIT.353.15 (1-1)	Push - 1...10V	€ 59,00
3KIT.354.18 (1-1)	IGBT - TRIAC	€ 32,00

Emergency unit: (inverter + battery. Driver not included)		
3KIT.900.01 (1-1)	1:00 hour/ora	€ 95,00
3KIT.900.03 (1-1)	3:00 hours/ore	€ 137,00

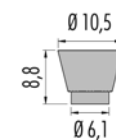

Housing for brickwork

- 1M00.067.01 € 10,00

(m-M) = min. Led unit - Max Led unit.
Led and Emergency unit, warranty only when used
together with driver bought from Oty srl.

Pop 05 Ø 8,2 (only for brickwork) 

- Frame
- 02 ● Black
- 06 ○ White

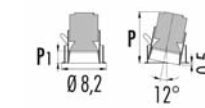

	Pop P05	P	P1
3P05.210.□	GU10	11,0	2,5
3P05.211.□	GU10 led	—	2,5
3P05.220.□	GU5.3	9,4	2,5
3P05.3□ M.□	led IP40	10,5	0,5
3P05.3□ S.□	led IP40	11,4	2,5
3P05.3□ T.□	led IP40	9,4	0,5
4P05.3□ M.□	led IP40 + honeycomb	11,0	0,5
4P05.3□ S.□	led IP40 + honeycomb	11,9	2,5
4P05.3□ T.□	led IP40 + honeycomb	9,9	0,5
3P05.3WM.□	led IP40	6,8	0,5
3P05.3WS.□	led IP40	8,8	2,5
4P05.3WM.□	led IP40 + honeycomb	7,3	0,5
4P05.3WS.□	led IP40 + honeycomb	9,3	2,5

IP40	DimToWarm	CE	V	⊕
220V ÷ 240V	LED 6W CRI 95			Driver incluso
3P05.3W□.□	dimm IGBT - TRIAC	€ 160,00		
4P05.3W□.□	dimm IGBT - TRIAC	€ 166,00		
With honeycomb				
■ Led color	Nominal lm	▲ Beam spread		
W= max 3000°K	max 445 lm	M = 30°		
min. 1800°K	min. 10 lm	S = 18°		

- Frame
- 02 ● Black
- 06 ○ White

IP20	CE	V	⊕
220V ÷ 240V			
3P05.210.□	GU10	max 50W	€ 59,00
3P05.211.□	GU10 led		€ 59,00
4P05.211.□	GU10 led		€ 65,00
With honeycomb			

IP20	CE	V	⊕
12V			
3P05.220.□	GU5.3	max 50W	€ 58,00
4P05.220.□	GU5.3 led		€ 64,00
With honeycomb			
3KIT.201.050		max 50VA	€ 32,00
Dimmable gear: IGBT			

IP40	MC-E=3	CE	V	⊕
350m/A	LED 11W	CRI>90		
3P05.3□ M.□			€ 107,00	
4P05.3□ M.□			€ 113,00	
With honeycomb				

■ Led color	Nominal lm	▲ Beam spread
2 = 2700°K	1195	M = 38°
3 = 3000°K	1257	S = 22°
4 = 4000°K	1313	T = 10°

© (m-M)	Driver	
3KIT.350.1L (1-1)	on/off	€ 21,00
3KIT.351.40 (1-3)	DALI - Push - 1...10V Remote installation	€ 105,00
3KIT.352.15 (1-1)	DALI	€ 59,00
3KIT.353.15 (1-1)	Push - 1...10V	€ 59,00
3KIT.354.18 (1-1)	IGBT - TRIAC	€ 32,00

Emergency unit: (inverter + battery. Driver not included)		
3KIT.900.01 (1-1)	1:00 hour/ora	€ 95,00
3KIT.900.03 (1-1)	3:00 hours/ore	€ 137,00

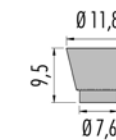

Housing for brickwork

- 1M00.082.01 € 10,00

(m-M) = min. Led unit - Max Led unit.
Led and Emergency unit, warranty only when used
together with driver bought from Oty srl.

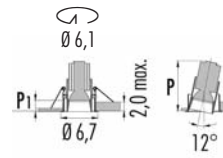
Pop 05 Wing Ø 6,7 (only for plasterboard) 

□	Frame
02 ●	Black
06 ○	White

Pop PW05	P	P1
3PW05.200.□	GU4	8,5 2,5
3PW05.201.□	GU4 led	— 2,5
3PW05.3 ■ S.□	led	11,6 3,7

IP20	CE	V	⚡
12V			
3PW05.200.□	GU4	max 35W	€ 53,00
3KIT.201.050		max 50VA	€ 32,00
Dimmable gear: IGBT			

IP40	CE	V	⚡
350m/A	LED 11W	CRI>90	
3PW05.2 ■ S.□			€ 107,00
■ Led color	Nominal lm	▲ Beam spread	
2 = 2700°K	1195	22°	
3 = 3000°K	1257		
4 = 4000°K	1313		

© (m-M)	Driver	
3KIT.350.1L (1-1)	on/off	€ 21,00
3KIT.351.40 (1-3)	DALI - Push - 1...10V Remote installation	€ 105,00
3KIT.352.15 (1-1)	DALI	€ 59,00
3KIT.353.15 (1-1)	Push - 1...10V	€ 59,00
3KIT.354.18 (1-1)	IGBT - TRIAC	€ 32,00

Emergency unit: (inverter + battery. Driver not included)		
3KIT.900.01 (1-1)	1:00 hour/ora	€ 95,00
3KIT.900.03 (1-1)	3:00 hours/ore	€ 137,00

(m-M) = min. Led unit - Max Led unit.
Led and Emergency unit, warranty only when used
together with driver bought from Oty srl.

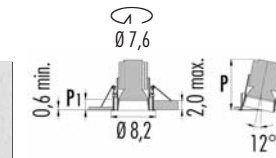
Pop 05 Wing Ø 8,2 (only for plasterboard) 

□	Frame
02 ●	Black
06 ○	White

Pop PW05	P	P1
3PW05.210.□	GU10	11,0 2,5
3PW05.211.□	GU10 led	— 2,5
3PW05.220.□	GU5.3	9,4 2,5
3PW05.3 ■ M.□	led IP40	10,5 0,5
3PW05.3 ■ S.□	led IP40	11,4 2,5
3PW05.3 ■ T.□	led IP40	9,4 0,5
4PW05.3 ■ M.□	led IP40 + honeycomb	11,0 0,5
4PW05.3 ■ S.□	led IP40 + honeycomb	11,9 2,5
4PW05.3 ■ T.□	led IP40 + honeycomb	9,9 0,5
3PW05.3WM.□	led IP40	7,3 0,5
3PW05.3WS.□	led IP40	9,3 2,5
4PW05.3WM.□	led IP40 + honeycomb	7,3 0,5
4PW05.3WS.□	led IP40 + honeycomb	9,3 2,5

IP20	CE	V	⚡
220V ÷ 240V			
3PW05.210.□	GU10	max 50W	€ 65,00
3PW05.211.□	GU10 led		€ 65,00
4PW05.211.□	GU10 led		€ 71,00
With honeycomb			

IP20	CE	V	⚡
12V			
3PW05.220.□	GU5.3	max 50W	€ 64,00
4PW05.220.□	GU5.3 led		€ 70,00
With honeycomb			
3KIT.201.050		max 50VA	€ 32,00
Dimmable gear: IGBT			

IP40	MC-E=3	CE	V	⚡
350m/A	LED 11W	CRI>90		
3PW05.3 ■ M.□				€ 117,00
4PW05.3 ■ M.□				€ 123,00
With honeycomb				
■ Led color	Nominal lm	▲ Beam spread		
2 = 2700°K	1195	M = 38°		
3 = 3000°K	1257	S = 22°		
4 = 4000°K	1313	T = 10°		

© (m-M)	Driver	
3KIT.350.1L (1-1)	on/off	€ 21,00
3KIT.351.40 (1-3)	DALI - Push - 1...10V Remote installation	€ 105,00
3KIT.352.15 (1-1)	DALI	€ 59,00
3KIT.353.15 (1-1)	Push - 1...10V	€ 59,00
3KIT.354.18 (1-1)	IGBT - TRIAC	€ 32,00

Emergency unit: (inverter + battery. Driver not included)		
3KIT.900.01 (1-1)	1:00 hour/ora	€ 95,00
3KIT.900.03 (1-1)	3:00 hours/ore	€ 137,00

IP40	DimToWarm	CE	V	⚡
220V ÷ 240V	LED 6W	CRI 95	Driver incluso	
3PW05.3W ■ T.□	dim IGBT - TRIAC			€ 175,00
4PW05.3W ■ T.□	dim IGBT - TRIAC			€ 181,00
With honeycomb				

■ Led color	Nominal lm	▲ Beam spread
W= max 3000°K	max 445 lm	M = 30°
min. 1800°K	min. 10 lm	S = 18°

(m-M) = min. Led unit - Max Led unit.
Led and Emergency unit, warranty only when used
together with driver bought from Oty srl.

Pop Ring Static Ø 7,0 (only for plasterboard)

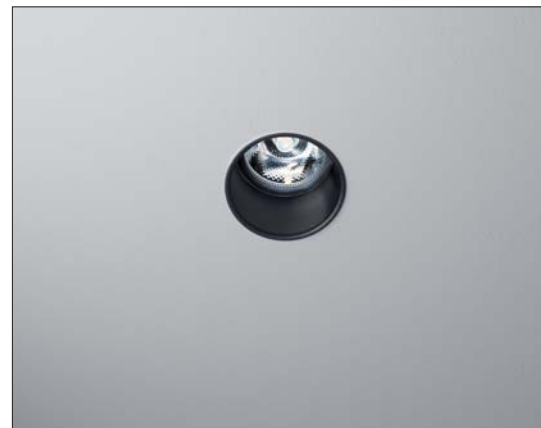

	Pop PRS1	P	P1
3PRS.210.□	GU10	12,6	4,4
3PRS.220.□	GU5.3	10,4	4,4
4PRS.220.□	GU5.3 led + honeycomb	10,9	4,4
3PRS.220.□	GU5.3 IP44	10,4	4,0
4PRS.220.□	GU5.3 IP44 led + honeycomb	10,9	4,0
3PRS.3.■▲.□	Led IP40	13,7	4,4
4PRS.3.■▲.□	Led IP40+ honeycomb	14,2	4,4
3PRS.3.■▲.□	Led IP54	13,7	4,0
4PRS.3.■▲.□	Led IP54 + honeycomb	14,2	4,0
3PRS.3W.■▲.□	Led IP40	10,9	4,4
4PRS.3W.■▲.□	Led IP40 + honeycomb	11,4	4,4
3PRS.3W.■▲.□	Led IP54	10,9	4,0
4PRS.3W.■▲.□	Led IP54 + honeycomb	11,4	4,0

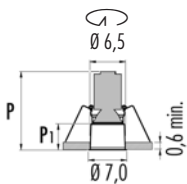

IP20	CE	V	□
220V ÷ 240V			
3PRS.210.□	GU10	max 50W	€ 69,00
4PRS.210.□	GU10	led	€ 75,00
<i>With honeycomb</i>			

IP20	CE	V	□
12V			
3PRS.220.□	GU5.3	max 50W	€ 69,00
4PRS.220.□	GU5.3	led	€ 75,00
<i>With honeycomb</i>			
3KIT.201.050		max 50VA	€ 32,00
<i>Dimmable gear: IGBT</i>			

IP44	CE	V	□
12V			
3PRS.220.□	GU5.3	led	€ 80,00
4PRS.220.□	GU5.3	led	€ 86,00
<i>With honeycomb</i>			
3KIT.201.050		max 50VA	€ 32,00
<i>Dimmable gear: IGBT</i>			

□	Frame
02	Black
06	White

IP40	MC-E=3	CE	V	□
350m/A				
3PRS.3.■▲.□	LED 11W		CRI>90	€ 95,00
4PRS.3.■▲.□				€ 101,00
<i>With honeycomb</i>				

IP54	MC-E=3	CE	V	□
350m/A				
3PRS.3.■▲.□	LED 11W		CRI>90	€ 120,00
4PRS.3.■▲.□				€ 126,00
<i>With honeycomb</i>				

■ Led color	Nominal lm	▲ Beam spread
2 = 2700°K	1195	S = 22°
3 = 3000°K	1257	T = 12°
4 = 4000°K	1313	

© (m-M)	Driver	
3KIT.350.1L (1-1)	on/off	€ 21,00
3KIT.350.25 (2-2)	on/off	€ 35,00
3KIT.351.40 (1-3)	DALI - Push - 1...10V Remote installation	€ 105,00
3KIT.352.15 (1-1)	DALI	€ 59,00
3KIT.353.15 (1-1)	Push - 1...10V	€ 59,00
3KIT.354.18 (1-1)	IGBT - TRIAC	€ 32,00

Emergency unit: (inverter + battery. Driver not included)		
3KIT.900.01 (1-1)	1:00 hour/ora	€ 95,00
3KIT.900.03 (1-1)	3:00 hours/ore	€ 137,00

IP40	DimToWarm	CE	V	□
220V ÷ 240V	LED 6W		CRI 95	Driver incluso
3PRS.3W.■▲.□	IGBT - TRIAC			€ 145,00
4PRS.3W.■▲.□	IGBT - TRIAC			€ 151,00
<i>With honeycomb</i>				

IP54	DimToWarm	CE	V	□
220V ÷ 240V	LED 6W		CRI 95	Driver incluso
3PRS.3W.■▲.□	IGBT - TRIAC			€ 160,00
4PRS.3W.■▲.□	IGBT - TRIAC			€ 166,00
<i>With honeycomb</i>				

■ Led color	Nominal lm	▲ Beam spread
W= max 3000°K	max 445 lm	M = 30°
min. 1800°K	min. 10 lm	S = 18°

Pop Ring Static Ø 13,1 (only for plasterboard)

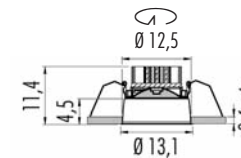

□	Frame
02	Black
06	White

IP40	MC-E=3	CE	V	□
350 - 500 - 700 m/A				
3PRS.6.■▲.□			CRI>90	€ 155,00 ▼
<i>With honeycomb</i>				
IP54	MC-E=3	CE	V	□
350 - 500 - 700 m/A				
3PRS.6.■▲.□			CRI>90	€ 170,00 ▼
<i>With honeycomb</i>				

© (m-M)	LED 12,5W	350m/A
3KIT.350.1L (1-1)	on/off	€ 21,00
3KIT.351.40 (1-3)	DALI - Push - 1...10V	€ 105,00
3KIT.352.15 (1-1)	DALI	€ 59,00
3KIT.353.15 (1-1)	Push - 1...10V	€ 59,00
3KIT.354.18 (1-1)	IGBT - TRIAC	€ 32,00
■ Led color	Nominal lm	▲ Beam spread
2 = 2700°K	1477	L = 60°
3 = 3000°K	1565	S = 24°
4 = 4000°K	1635	T = 12°

© (m-M)	LED 18,4W	500m/A
3KIT.500.1L (1-1)	on/off	€ 21,00
3KIT.501.50 (1-3)	DALI - Push - 1...10V	€ 105,00
3KIT.502.20 (1-1)	DALI	€ 59,00
3KIT.503.20 (1-1)	Push - 1...10V	€ 59,00
3KIT.504.20 (1-1)	IGBT - TRIAC	€ 32,00
■ Led color	Nominal lm	▲ Beam spread
2 = 2700°K	2020	L = 60°
3 = 3000°K	2140	S = 24°
4 = 4000°K	2236	T = 12°

© (m-M)	LED 27W	700m/A
3KIT.700.1L (1-1)	on/off	€ 24,00
3KIT.701.50 (1-1)	DALI - Push - 1...10V	€ 105,00
■ Led color	Nominal lm	▲ Beam spread
2 = 2700°K	2683	L = 60°
3 = 3000°K	2842	S = 24°
4 = 4000°K	2963	T = 12°

Emergency unit: (inverter + battery. Driver not included)		
3KIT.900.01 (1-1)	1:00 hour/ora	€ 95,00
3KIT.900.03 (1-1)	3:00 hours/ore	€ 137,00

(m-M) = min. Led unit - Max Led unit.
Led and Emergency unit, warranty only when used
together with driver bought from Oty srl.

Pop Ring Dynamic Ø 13,1 (only for plasterboard)



□ Frame

02 ● Black

06 ○ White

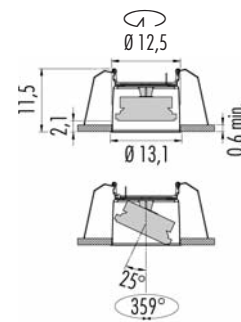

IP20

12V

3PR1D.530.□ **653** max 50W € 135,00 ▼

3KIT.201.050 max 50VA € 32,00

Dimmable gear: IGBT

IP20 MC-E=3

350 - 500 m/A

3PR1D.5 € 200,00 ▼

© (m-M) **LED 12,5W** 350m/A

3KIT.350.1L (1-1) on/off € 21,00

3KIT.351.40 (1-3) DALI - Push - 1...10V € 105,00

3KIT.352.15 (1-1) DALI € 59,00

3KIT.353.15 (1-1) Push - 1...10V € 59,00

3KIT.354.18 (1-1) IGBT - TRIAC € 32,00

■ Led color Nominal lm ▲ Beam spread

2 = 2700°K 1477 L = 60°

3 = 3000°K 1565 S = 24°

4 = 4000°K 1635 T = 12°

© (m-M) **LED 18,4W** 500m/A

3KIT.500.1L (1-1) on/off € 21,00

3KIT.501.50 (1-3) DALI - Push - 1...10V € 105,00

3KIT.502.20 (1-1) DALI € 59,00

3KIT.503.20 (1-1) Push - 1...10V € 59,00

3KIT.504.20 (1-1) IGBT - TRIAC € 32,00

■ Led color Nominal lm ▲ Beam spread

2 = 2700°K 2020 L = 60°

3 = 3000°K 2140 S = 24°

4 = 4000°K 2236 T = 12°

Emergency unit: (inverter + battery. Driver not included)

3KIT.900.01 (1-1) 1:00 hour/ora € 95,00

3KIT.900.03 (1-1) 3:00 hours/ore € 137,00

(m-M) = min. Led unit - Max Led unit.
Led and Emergency unit, warranty only when used
together with driver bought from Oty srl.

Pop Ring Dynamic Ø 13,1 (only for plasterboard)



□ Frame

02 ● Black

06 ○ White

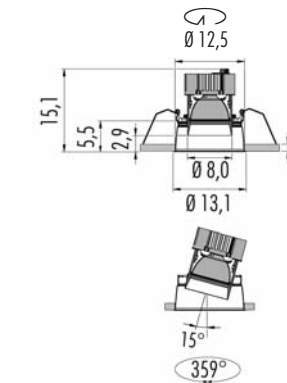

IP40 MC-E=3

500 - 700 m/A

3PR1D.6 € 246,00

© (m-M) **LED 18,4W** 500m/A

3KIT.500.1L (1-1) on/off € 21,00

3KIT.501.50 (1-3) DALI - Push - 1...10V € 105,00

3KIT.502.20 (1-1) DALI € 59,00

3KIT.503.20 (1-1) Push - 1...10V € 59,00

3KIT.504.20 (1-1) IGBT - TRIAC € 32,00

■ Led color Nominal lm ▲ Beam spread

2 = 2700°K 2020 M = 54°

3 = 3000°K 2140 S = 26°

4 = 4000°K 2236 T = 17°

© (m-M) **LED 27W** 700m/A

3KIT.700.1L (1-1) on/off € 24,00

3KIT.701.50 (1-1) DALI - Push - 1...10V € 105,00

■ Led color Nominal lm ▲ Beam spread

2 = 2700°K 2683 M = 54°

3 = 3000°K 2842 S = 26°

4 = 4000°K 2963 T = 17°

Emergency unit: (inverter + battery. Driver not included)

3KIT.900.01 (1-1) 1:00 hour/ora € 95,00

3KIT.900.03 (1-1) 3:00 hours/ore € 137,00

(m-M) = min. Led unit - Max Led unit.
Led and Emergency unit, warranty only when used
together with driver bought from Oty srl.

Pop Ring Pull Ø 12,5 (only for plasterboard)

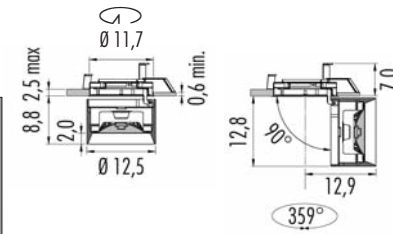

IP20	MC-E=3	CE	350 m/A	CRI>90
3PR1P.5			€ 280,00	

© (m-M)	LED 12,5W	350m/A
3KIT.350.1L (1-1)	on/off	€ 21,00
3KIT.351.40 (1-3)	DALI - Push - 1...10V	€ 105,00
3KIT.352.15 (1-1)	DALI	€ 59,00
3KIT.353.15 (1-1)	Push - 1...10V	€ 59,00
3KIT.354.18 (1-1)	IGBT - TRIAC	€ 32,00

■ Led color	Nominal lm	▲ Beam spread
2 = 2700°K	1477	L = 60°
3 = 3000°K	1565	S = 24°
4 = 4000°K	1635	T = 12°

□	Frame
02 ●	Black
06 ○	White

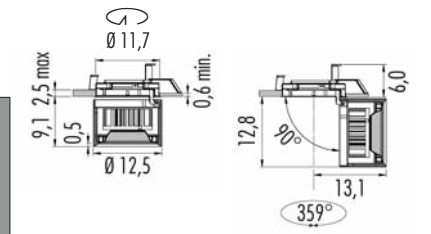

IP20	MC-E=3	CE	500 m/A - 600 m/A	CRI>90
3PR1P.6			€ 325,00	

© (m-M)	LED 18,4W	500m/A
3KIT.500.1L (1-1)	on/off	€ 21,00
3KIT.501.50 (1-3)	DALI - Push - 1...10V	€ 105,00
3KIT.502.20 (1-1)	DALI	€ 59,00
3KIT.503.20 (1-1)	Push - 1...10V	€ 59,00
3KIT.504.20 (1-1)	IGBT - TRIAC	€ 32,00

■ Led color	Nominal lm	▲ Beam spread
2 = 2700°K	2020	L = 60°
3 = 3000°K	2140	S = 24°
4 = 4000°K	2236	T = 12°

© (m-M)	LED 23W	600m/A
3KIT.600.1L (1-1)	on/off	€ 24,00
3KIT.601.50 (1-1)	DALI - Push - 1...10V	€ 105,00

■ Led color	Nominal lm	▲ Beam spread
2 = 2700°K	2228	L = 60°
3 = 3000°K	2357	S = 24°
4 = 4000°K	2455	T = 12°

Emergency unit: (inverter + battery. Driver not included)

3KIT.900.01 (1-1)	1:00 hour/ora	€ 95,00
3KIT.900.03 (1-1)	3:00 hours/ore	€ 137,00

IP20	12V	CE	3PR1P.530.□	653 max 50W	€ 199,00
			3KIT.201.050	max 50VA	€ 32,00

Dimmable gear: IGBT

(m-M) = min. Led unit - Max Led unit.
Led and Emergency unit, warranty only when used
together with driver bought from Oty srl.

Pop 06 $\varnothing 6,0$ 

- Frame
- 02 ● Black
- 06 ○ White

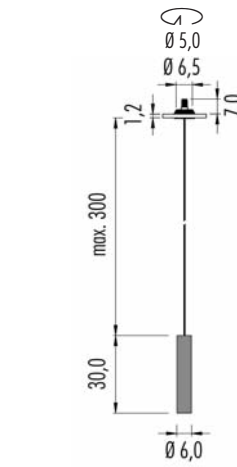

IP20	ARC	CE	MC-E=3
220-240V			
3P06A.210 □	GU10 1x50W	€ 220,00	
IP20	Flicker < 20%	CE	MC-E=3
220-240V	9,5W	CRI>90	
3P06A.K ■ S. □	dim. IGBT - TRIAC	€ 270,00 ▼	
■ Led color	Nominal lm	Beam spread	
2 = 2700 °K	710	24°	
3 = 3000 °K	760		

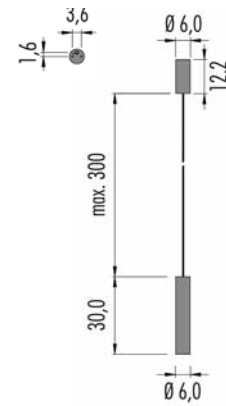

IP20	CUP	CE	MC-E=3
220-240V			
3P06.210 □	GU10 1x50W	€ 220,00	
IP20	Flicker < 20%	CE	MC-E=3
220-240V	9,5W	CRI>90	
3P06.K ■ S. □	dim. IGBT - TRIAC	€ 270,00 ▼	
■ Led color	Nominal lm	Beam spread	
2 = 2700 °K	710	24°	
3 = 3000 °K	760		

Pop 06 $\varnothing 12,0$ ROS

- Frame
- 02 ● Black
- 06 ○ White

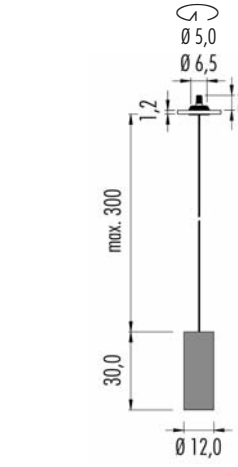

IP54	ARC	CE	MC-E=3
220-240V	18,5W	CRI>90	
3P06A.5 ■ S. □	dim. IGBT - TRIAC	€ 450,00 ▼	
■ Led color	Nominal lm	Beam spread	
2 = 2700 °K	2683	24°	
3 = 3000 °K	2842		
4 = 4000 °K	2963		

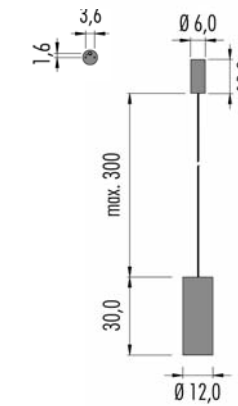

IP54	CUP	CE	MC-E=3
220-240V	18,5W	CRI>90	
3P06.5 ■ S. □	dim. IGBT - TRIAC	€ 455,00 ▼	
■ Led color	Nominal lm	Beam spread	
2 = 2700 °K	2683	24°	
3 = 3000 °K	2842		
4 = 4000 °K	2963		

Pop 06 Ø 6,0 bi-color



ARC: recessed canopy for plasterboard or wood ceiling - CUP: external canopy

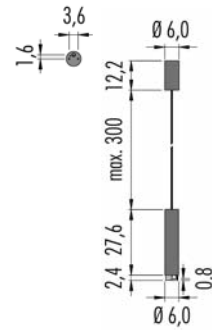
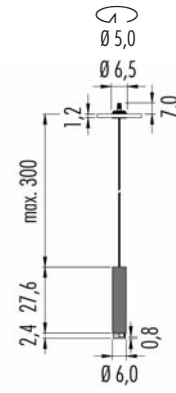

IP20	ARC	Flicker < 20%	CE	MC-E=3
220-240V		9,5W CRI>90	dim. IGBT - TRIAC	
3P06A.K	S.KS		€ 350,00	
3P06A.K	S.WS		€ 350,00	
3P06A.K	S.BS		€ 370,00	
3P06A.K	S.GS		€ 370,00	
3P06A.K	S.PS		€ 370,00	
3P06A.K	S.RS		€ 370,00	
	Led color	Nominal lm	Beam spread	
	2 = 2700°K	710	24°	
	3 = 3000°K	760		

IP20	CUP	Flicker < 20%	CE	MC-E=3
220-240V		9,5W CRI>90	dim. IGBT - TRIAC	
3P06C.K	S.KS		€ 350,00	
3P06C.K	S.WS		€ 350,00	
3P06C.K	S.BS		€ 370,00 ▼	
3P06C.K	S.GS		€ 370,00 ▼	
3P06C.K	S.PS		€ 370,00 ▼	
3P06C.K	S.RS		€ 370,00 ▼	
	Led color	Nominal lm	Beam spread	
	2 = 2700°K	710	24°	
	3 = 3000°K	760		

	Up	Down	ARC	CUP	cable
KS	●	●	Black/Brass	White	Black Brass
WS	○	●	White/Brass	White	White Brass
BS	●	●	Blue/Brass	White	Blue Brass
GS	●	●	Green/Brass	White	Green Brass
PS	●	●	Rose/Brass	White	Rose Brass
RS	●	●	Red/Brass	White	Red Brass

Time delivery: 25 Working Days

Pop 06 Ø 12,0 bi-color



ARC: recessed canopy for plasterboard or wood ceiling - CUP: external canopy

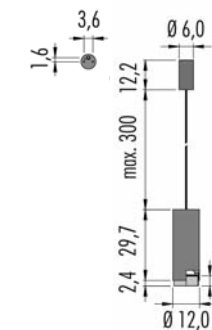
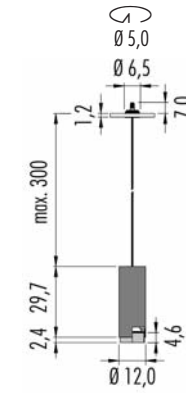

IP20	ARC	Flicker < 20%	CE	MC-E=3
220-240V		18,5W CRI>90	dim. IGBT - TRIAC	
3P06A.5	S.KS		€ 575,00	
3P06A.5	S.WS		€ 575,00	
3P06A.5	S.BS		€ 620,00	
3P06A.5	S.GS		€ 620,00	
3P06A.5	S.PS		€ 620,00	
3P06A.5	S.RS		€ 620,00	
	Led color	Nominal lm	Beam spread	
	2 = 2700°K	2176	24°	
	3 = 3000°K	2301		
	4 = 4000°K	2400		

IP20	CUP	Flicker < 20%	CE	MC-E=3
220-240V		18,5W CRI>90	dim. IGBT - TRIAC	
3P06C.5	S.KS		€ 575,00	
3P06C.5	S.WS		€ 575,00	
3P06C.5	S.BS		€ 650,00	
3P06C.5	S.GS		€ 650,00	
3P06C.5	S.PS		€ 650,00	
3P06C.5	S.RS		€ 650,00	
	Led color	Nominal lm	Beam spread	
	2 = 2700°K	2176	24°	
	3 = 3000°K	2301		
	4 = 4000°K	2400		

	Up	Down	ARC	CUP	cable
KS	●	●	Black/Brass	White	Black Brass
WS	○	●	White/Brass	White	White Brass
BS	●	●	Blue/Brass	White	Blue Brass
GS	●	●	Green/Brass	White	Green Brass
PS	●	●	Rose/Brass	White	Rose Brass
RS	●	●	Red/Brass	White	Red Brass

Time delivery: 25 Working Days

Pop 07 $\varnothing 6,0$ 

Frame

02 Black

06 White

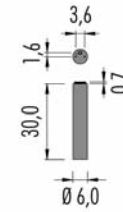

IP20		CE	▽
220-240V			
3P07.210.	GU10 1x50W	€	94,00

IP20	Flicker < 20%	CE	▽	MC-E=3
220-240V	9,5W	CRI>90		
3P07.K	dim. IGBT - TRIAC	€	170,00	▼

Led color	Nominal lm	Beam spread
2 = 2700°K	710	24°
3 = 3000°K	760	

Pop 07 $\varnothing 12,0$ ROS

Frame

02 Black

06 White

IP54		CE	▽	MC-E=3
220-240V	18,5W	CRI>90	dim. IGBT - TRIAC	
3P07.5	dim. IGBT - TRIAC	€	375,00	

Led color	Nominal lm	Beam spread
2 = 2700°K	2176	24°
3 = 3000°K	2301	
4 = 4000°K	2400	

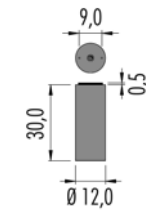

Pop 07 \varnothing 6,0 bi-color
 Up Down

KS		Black/Brass
WS		White/Brass
BS		Blue/Brass
GS		Green/Brass
PS		Rose/Brass
RS		Red/Brass

Time delivery: 25 Working Days

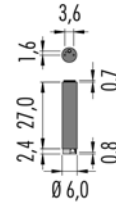

IP20	Flicker < 20%	CE	MC-E=3
220-240V	9,5W CRI>90	dimm. IGBT - TRIAC	
3P07.K S.KS		€ 175,00	▼
3P07.K S.WS		€ 175,00	▼
3P07.K S.BS		€ 190,00	▼
3P07.K S.GS		€ 190,00	▼
3P07.K S.PS		€ 190,00	▼
3P07.K S.RS		€ 190,00	▼
■ Led color	Nominal lm	Beam spread	
2 = 2700°K	710	24°	
3 = 3000°K	760		

Pop 07 \varnothing 12,0 bi-color
 Up Down

KS		Black/Brass
WS		White/Brass
BS		Blue/Brass
GS		Green/Brass
PS		Rose/Brass
RS		Red/Brass

Time delivery: 25 Working Days

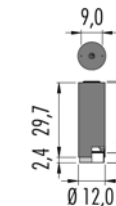

IP20	©	CE	MC-E=3
220-240V	18,5W CRI>90	dimm. IGBT - TRIAC	
3P07.5 S.KS		€ 415,00	
3P07.5 S.WS		€ 415,00	
3P07.5 S.BS		€ 450,00	
3P07.5 S.GS		€ 450,00	
3P07.5 S.PS		€ 450,00	
3P07.5 S.RS		€ 450,00	
IP20	©	CE	MC-E=3
220-240V	18,5W CRI>90	dimm. DALI	
3P07A5 S.KS		€ 440,00	
3P07A5 S.WS		€ 440,00	
3P07A5 S.BS		€ 470,00	
3P07A5 S.GS		€ 470,00	
3P07A5 S.PS		€ 470,00	
3P07A5 S.RS		€ 470,00	
IP20	©	CE	MC-E=3
220-240V	18,5W CRI>90	dimm. Push	
3P07B5 S.KS		€ 440,00	
3P07B5 S.WS		€ 440,00	
3P07B5 S.BS		€ 470,00	
3P07B5 S.GS		€ 470,00	
3P07B5 S.PS		€ 470,00	
3P07B5 S.RS		€ 470,00	
IP20	©	CE	MC-E=3
220-240V	18,5W CRI>90	dimm. 1...10V	
3P07C5 S.KS		€ 440,00	
3P07C5 S.WS		€ 440,00	
3P07C5 S.BS		€ 470,00	
3P07C5 S.GS		€ 470,00	
3P07C5 S.PS		€ 470,00	
3P07C5 S.RS		€ 470,00	
■ Led color	Nominal lm	Beam spread	
2 = 2700°K	2176	24°	
3 = 3000°K	2301		
4 = 4000°K	2400		

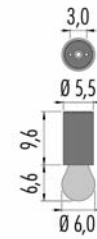
Pop 07 *small Bulb* Ceiling

	Frame	Bulb
02	Black	Transparent
06	White	Transparent
C1	Copper Anodized	Transparent
S1	Brass Anodized	Transparent

Available from 30/09/2019

IP20	CE	CE
220V ÷ 240V	e27 4W	CRI>80
3P07.A2L	dim. IGBT - TRIAC	€ 75,00
Led color	Nominal lm	Beam spread
2700°K	470	360°

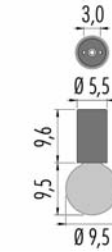
Pop 07 *big Bulb* Ceiling

	Frame	Bulb
02	Black	Transparent
06	White	Transparent
C1	Copper Anodized	Transparent
S1	Brass Anodized	Transparent

Available from 30/09/2019

IP20	CE	CE
220V ÷ 240V	e27 4W	CRI>80
3P07.B2L	dim. IGBT - TRIAC	€ 85,00
Led color	Nominal lm	Beam spread
2700°K	470	360°

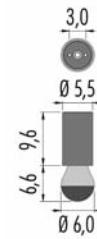
Pop 07 *small Bulb* ceiling/wall

	Frame	Bulb
02M	Black	Mirror Chrome
06M	White	Mirror Chrome
C1C	Copper Anodized	Mirror Copper
S1S	Brass Anodized	Mirror Brass

Available from 30/09/2019

IP20	CE	CE
220V ÷ 240V	e27 7W	CRI>80
3P07.A2L	dim. IGBT - TRIAC	€ 80,00
Led color	Nominal lm	Beam spread
2700°K	806	180°

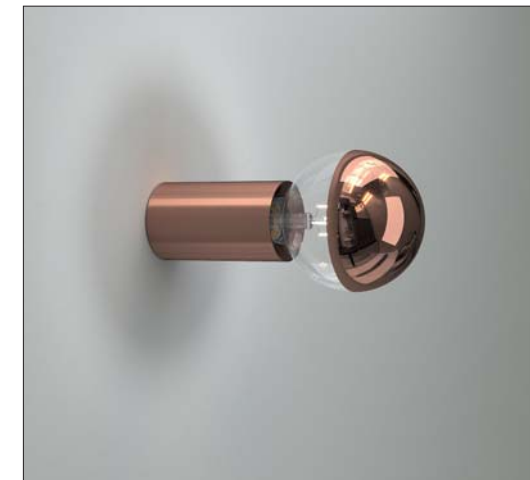
Pop 07 *big Bulb* ceiling/wall

	Frame	Bulb
02M	Black	Mirror Chrome
06M	White	Mirror Chrome
C1C	Copper Anodized	Mirror Copper
S1S	Brass Anodized	Mirror Brass

Available from 30/09/2019

IP20	CE	CE
220V ÷ 240V	e27 7W	CRI>80
3P07.B2L	dim. IGBT - TRIAC	€ 90,00
Led color	Nominal lm	Beam spread
2700°K	806	180°

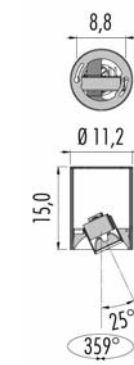
Pop X7 $\varnothing 11,2$ 

IP20	CE	CE	▽
220V ÷ 240V			
3PX7.211.□	GU10 led	€	180,00
4PX7.211.□	GU10 led	€	186,00
<i>With honeycomb</i>			
IP40	CE	▽	MC-E=3
220-240V	9,5W	CRI>90	dim. IGBT - TRIAC
3PX7.K	■▲.□	€	215,00
4PX7.K	■▲.□	€	221,00
<i>With honeycomb</i>			
■ Led color	Nominal lm	▲ Beam spread	
2 = 2700°K	834	M = 36°	
3 = 3000°K	877	S = 24°	

□	Frame
02 ●	Black
06 ○	White
C1 ●	Copper Anodized
S1 ●	Brass Anodized

Available from 30/09/2019
Time delivery: 25 Working Days

Pop W7

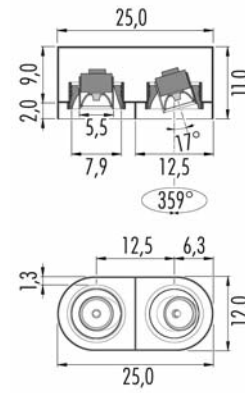

IP20	CE	▽	□
220-240V			
3PW7.211.□	GU10 led	€ 375,00	
4PW7.211.□	GU10 led	€ 387,00	
<i>With honeycomb</i>			

IP20	CE	▽	MC-E=3
2220-240V	2x9,5W	CRI>90	dim. IGBT - TRIAC
3PW7.K	▲	€ 410,00	
4PW7.K	▲	€ 426,00	
<i>With honeycomb</i>			
■ Led color	Nominal lm	▲ Beam spread	
2 = 2700°K	834	M = 36°	
3 = 3000°K	877	S = 24°	

	Out	In
02	● Black	● Black
KC1	● Black	● Copper Anodized
KS1	● Black	● Brass Anodized
06	○ White	○ White
WC1	○ White	○ Copper Anodized
WS1	○ White	○ Brass Anodized

Available from 30/09/2019

Time delivery: 25 Working Days



Pop 07 Dynamic Ø 12,5 ROS

- Frame
- 02 ● Black
- 06 ○ White

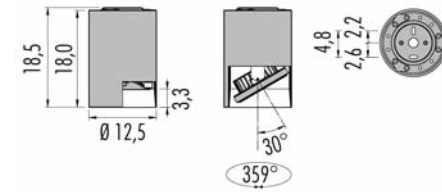

IP20	©	CE	MC-E=3
220-240V	18,5W	CRI>90	
3P07D.5	IGBT Triac	€ 330,00	▼
3P07DA5	DALI	€ 420,00	
3P07DG5	Push - 1...10V	€ 420,00	
■ Led color	Nominal lm	▲ Beam spread	
2 = 2700°K	2020	L = 60°	
3 = 3000°K	2140	S = 24°	
4 = 4000°K	2236	T = 12°	

Pop 07 Pull Ø 12,5



- Frame
- 02 ● Black
- 06 ○ White

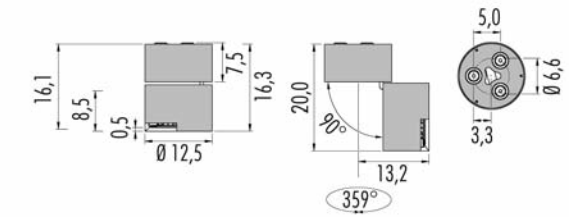

IP20	©	CE	MC-E=3
220-240V	18,4W	CRI>90	
3P07P.5	IGBT Triac	€ 375,00	▼
3P07PA5	DALI	€ 440,00	
3P07PG5	Push - 1...10V	€ 440,00	
■ Led color	Nominal lm	▲ Beam spread	
2 = 2700°K	2176	L = 60°	
3 = 3000°K	2301	S = 24°	
4 = 4000°K	2400	T = 12°	

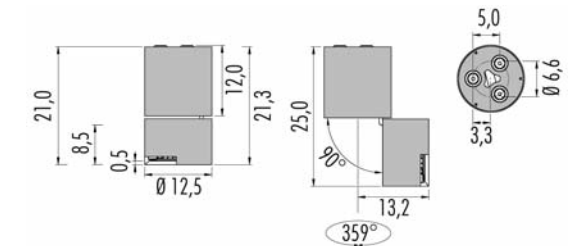

IP20	©	CE	MC-E=3
220-240V	23W	CRI>90	
3P07P.6	on/off	€ 399,00	▼
3P07PA6	DALI	€ 440,00	
3P07PG6	Push - 1...10V	€ 440,00	
■ Led color	Nominal lm	▲ Beam spread	
2 = 2700°K	2228	L = 60°	
3 = 3000°K	2357	S = 24°	
4 = 4000°K	2455	T = 12°	

IP20	Ⓢ	CE	▼
220-240V	653 1x50W		
3P07P.530		€ 290,00	▼

Pop 10 trimless (for plasterboard and brickwork)

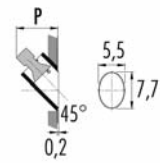

Code	Frame
02	Black
06	White

Code	P
3P10.210.□	GU10 9,2
3P10.211.□	GU10 Led —
3P10.220.□	GU5.3 8,4
3P10.3■S.□	350m/A led 12,6

IP20	CE	V	□
220V ÷ 240V			
3P10.210.□	GU10 max 50W	€	64,00
3P10.211.□	GU10 led	€	64,00

IP20	CE	V	⊕
12V			
3P10.220.□	GU5.3 max 50W	€	59,00
3KIT.201.050	max 50VA	€	32,00

Dimmable gear: IGBT

ONLY in the plasterboard ceiling to obtain wall - washed effects

IP20	CE	V	⊕
350m/A	LED 11W	CR>90	
3P10.3■S.□		€	120,00

■ Led color	Nominal lm	▲ Beam spread
2 = 2700°K	1195	24°
3 = 3000°K	1257	
4 = 4000°K	1313	

© (m-M) Driver

3KIT.350.1L (1-1)	on/off	€	21,00
3KIT.351.40 (1-3)	DALI - Push - 1...10V Remote installation	€	105,00
3KIT.352.15 (1-1)	DALI	€	59,00
3KIT.353.15 (1-1)	Push - 1...10V	€	59,00
3KIT.354.18 (1-1)	IGBT - TRIAC	€	32,00

Emergency unit: (inverter + battery. Driver not included)

3KIT.900.01 (1-1)	1:00 hour/ora	€	95,00
3KIT.900.03 (1-1)	3:00 hours/ore	€	137,00

Housing for plasterboard

● 1Z00.070.01	€	52,00
---------------	---	-------

Housing for brickwork

● 1M00.070.01	€	91,00
---------------	---	-------

(m-M) = min. Led unit - Max Led unit.
Led and Emergency unit, warranty only when used
together with driver bought from Oty srl.

Pop 11 trimless (only for plasterboard)

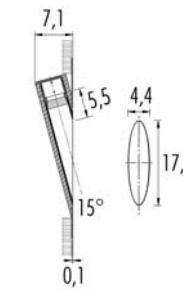
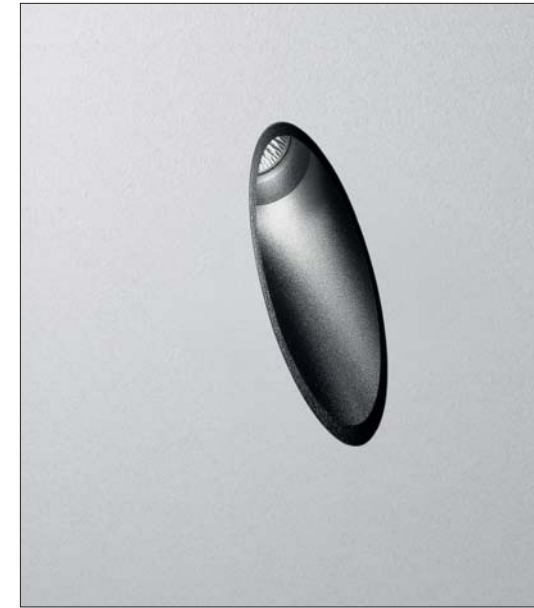

Code	Frame
02	Black
06	White

IP20	CE	V	⊕
12V			
3P11.200.□	GU4 1x35W	€	75,00
3KIT.201.050	max 50VA	€	32,00

Dimmable gear: IGBT

IP20	CE	V	⊕
700m/A	LED 2,4W	CR>80	
3P11.3■M.□	2,4W	€	118,00

■ Led color	Nominal lm	▲ Beam spread
3 = 3000°K	137	25°
4 = 4000°K	160	

© (m-M) Driver 700m/A

3KIT.700.12 (1-3)	on/off	€	27,00
3KIT.700.32 (1-9)	on/off	€	51,00
3KIT.701.50 (1-14)	DALI Push - 1...10V	€	105,00

Housing for plasterboard

● 1Z00.043.01	€	100,00
---------------	---	--------

Ceiling installation to obtain wall - washed effects

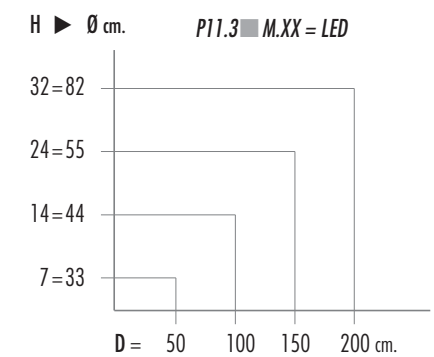
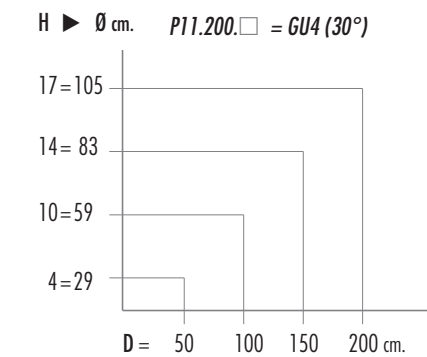
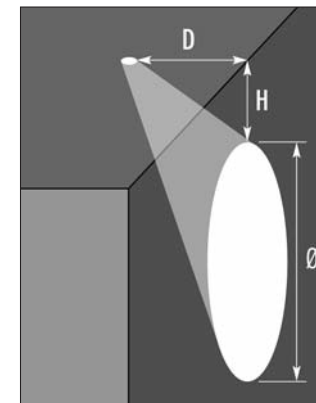

Pop P12 Ø 3,0 trimless (for plasterboard and brickwork)

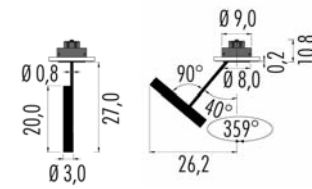

IP20	CE	LED 13,4W	CRI>90
350m/A			
3P12.2 M. □		€ 236,00	
4P12.2 M. □		€ 242,00	
With honeycomb			
■ Led color	Nominal lm	▲ Beam spread	
2 = 2700°K	1650	35°	
3 = 3000°K	1727		
4 = 4000°K	1786		

© (m-M)	Driver	
3KIT.350.1L (1-1)	on/off	€ 21,00
3KIT.351.40 (1-2)	DALI - Push - 1...10V Remote installation	€ 105,00
3KIT.352.15 (1-1)	DALI	€ 59,00
3KIT.353.15 (1-1)	Push - 1...10V	€ 59,00
3KIT.354.18 (1-1)	IGBT - TRIAC	€ 32,00

Emergency unit: (inverter + battery. Driver not included)

3KIT.900.01 (1-1)	1:00 hour/ora	€ 95,00
3KIT.900.03 (1-1)	3:00 hours/ore	€ 137,00

Housing for plasterboard

- 1Z00.080.01 Ø 9,5cm € 33,00

Housing for brickwork

- 1M00.080.01 € 96,00

□ Frame

- 02 ● Black
- 06 ○ White

(m-M) = min. Led unit - Max Led unit.
Led and Emergency unit, warranty only when used
together with driver bought from Oty srl.

Pop P12 T Ø 3,0 with trim (only for plasterboard)

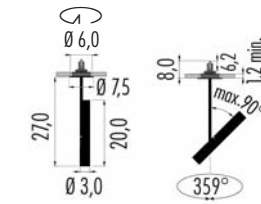

IP20	CE	LED 13,4W	CRI>90
350m/A			
3P12T.2 M. □		€ 236,00	
4P12T.2 M. □		€ 242,00	
With honeycomb			
■ Led color	Nominal lm	▲ Beam spread	
2 = 2700°K	1650	35°	
3 = 3000°K	1727		
4 = 4000°K	1786		

© (m-M)	Driver	
3KIT.350.1L (1-1)	on/off	€ 21,00
3KIT.351.40 (1-2)	DALI - Push - 1...10V Remote installation	€ 105,00
3KIT.352.15 (1-1)	DALI	€ 59,00
3KIT.353.15 (1-1)	Push - 1...10V	€ 59,00
3KIT.354.18 (1-1)	IGBT - TRIAC	€ 32,00

Emergency unit: (inverter + battery. Driver not included)

3KIT.900.01 (1-1)	1:00 hour/ora	€ 95,00
3KIT.900.03 (1-1)	3:00 hours/ore	€ 137,00

□ Frame

- 02 ● Black
- 06 ○ White

(m-M) = min. Led unit - Max Led unit.
Led and Emergency unit, warranty only when used
together with driver bought from Oty srl.

Pop P12/L Ø 3,0 trimless (only for plasterboard)

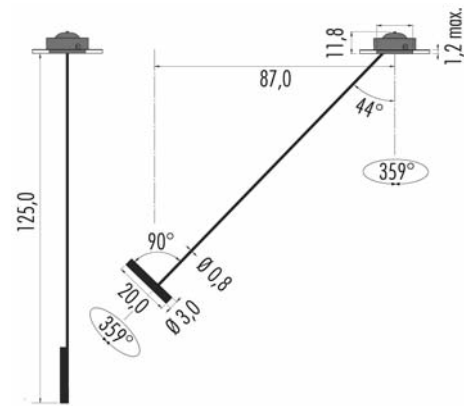

□ Frame

02 ● Black

06 ○ White

IP20	CE	LED 13,4W	CRI>90
350m/A			
3P12L.2 M. □		€ 386,00	
4P12L.2 M. □		€ 392,00	
<i>With honeycomb</i>			
■ Led color	Nominal lm	▲ Beam spread	
2 = 2700°K	1650	35°	
3 = 3000°K	1727		
4 = 4000°K	1786		

© (m-M)	Driver	
3KIT.350.1L (1-1)	on/off	€ 21,00
3KIT.351.40 (1-2)	DALI - Push - 1...10V Remote installation	€ 105,00
3KIT.352.15 (1-1)	DALI	€ 59,00
3KIT.353.15 (1-1)	Push - 1...10V	€ 59,00
3KIT.354.18 (1-1)	IGBT - TRIAC	€ 32,00

Emergency unit: (inverter + battery. Driver not included)

3KIT.900.01 (1-1)	1:00 hour/ora	€ 95,00
3KIT.900.03 (1-1)	3:00 hours/ore	€ 137,00

Housing for plasterboard with 1,2cm max thickness

- 1W00.125.01 ⌀12,5cm € 134,00

(m-M) = min. Led unit - Max Led unit.
Led and Emergency unit, warranty only when used
together with driver bought from Qty srl.

Pop P12/K Ø 3,0 ceiling

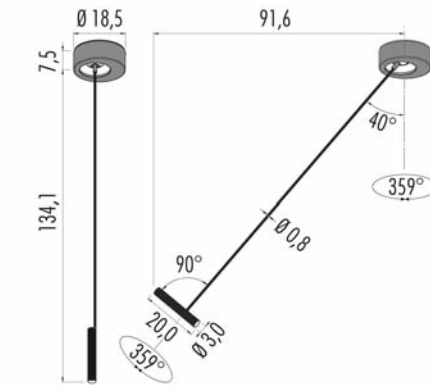

□ Frame

02 ● Black

06 ○ White

IP20	CE	LED 13,4W	CRI>90
220-240V			
3P12K.2 M. □	dim. IGBT - TRIAC	€ 541,00	
4P12K.2 M. □	dim. IGBT - TRIAC	€ 547,00	
<i>With honeycomb</i>			
3P12KA2 M. □	DALI	€ 560,00	
4P12KA2 M. □	DALI	€ 566,00	
<i>With honeycomb</i>			
3P12KG2 M. □	Push - 1...10V	€ 560,00	
4P12KG2 M. □	Push - 1...10V	€ 566,00	
<i>With honeycomb</i>			
■ Led color	Nominal lm	▲ Beam spread	
2 = 2700°K	1650	35°	
3 = 3000°K	1727		
4 = 4000°K	1786		

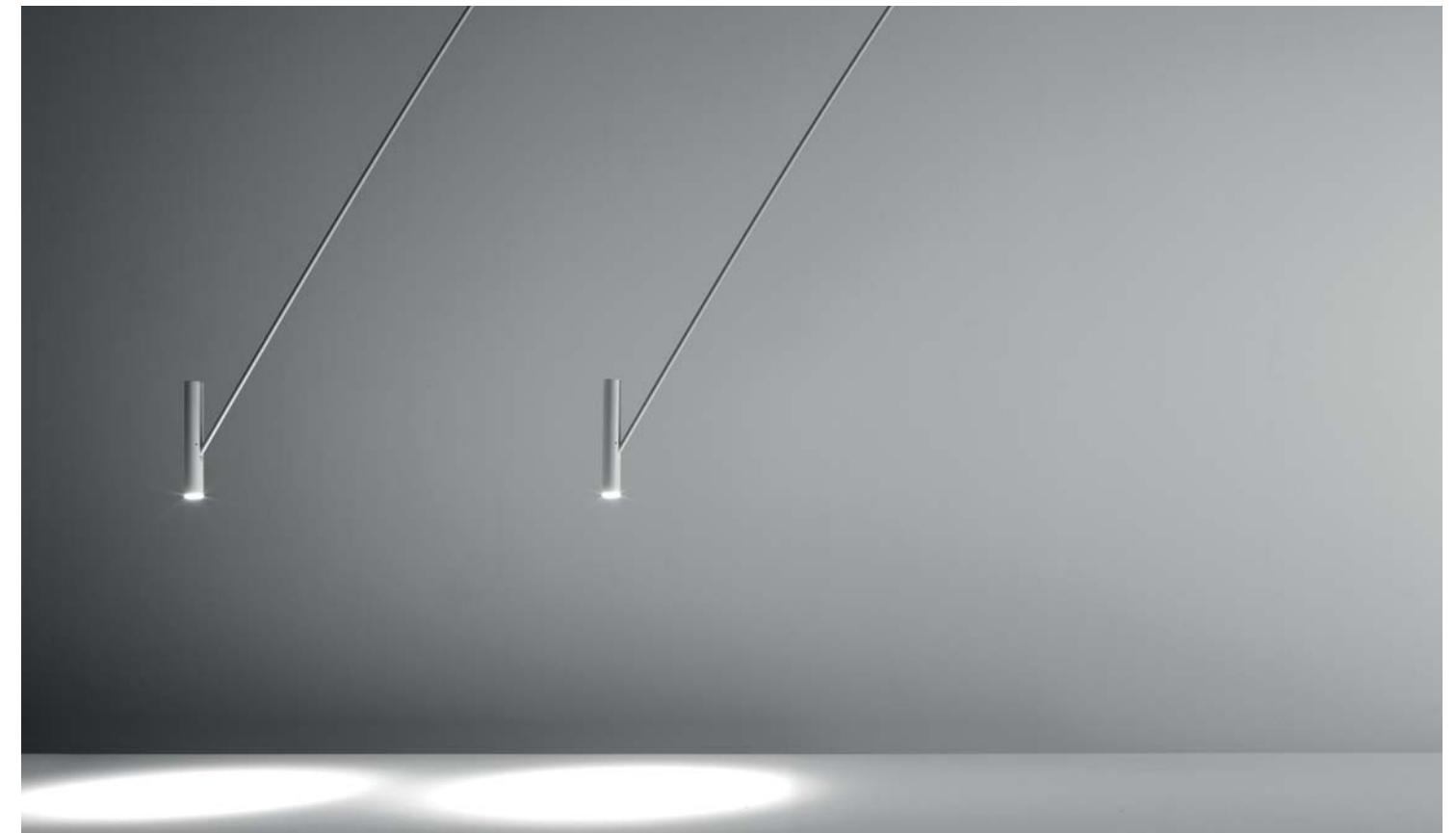

Pop P12 Ø 7,0 trimless (for plasterboard and brickwork)

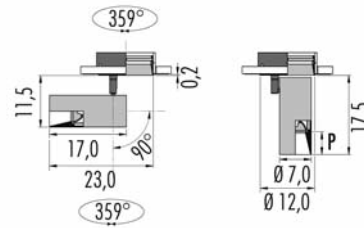

Frame	Color
02	Black
06	White

Code		Ø	P
3P12.210.□	GU10	7,0	5,0
3P12.220.□	GU5.3	7,0	5,0
3P12.3.■M.□	led	7,0	0,5
3P12.3.■S.□	led	7,0	5,0
3P12.3.■T.□	led	7,0	0,5
4P12.3.■M.□	led + honeycomb	7,0	0,5
4P12.3.■S.□	led + honeycomb	7,0	5,0
4P12.3.■T.□	led + honeycomb	7,0	0,5

IP20	CE	V	⊕
220V ÷ 240V			
3P12.210.□	GU10	max 50W	€ 198,00

IP20	CE	V	⊕
12V			
3P12.220.□	GU5.3	max 50W	€ 193,00
3KIT.201.050		max 50VA	€ 32,00
Dimmable gear: IGBT			

IP20	MC-E=3	CE	V	⊕
350m/A	LED 11W			CRI>90
3P12.3.■M.□			€ 246,00	
4P12.3.■M.□			€ 252,00	
With honeycomb				

Led color	Nominal lm	Beam spread
2 = 2700°K	1195	M = 38°
3 = 3000°K	1257	S = 22°
4 = 4000°K	1313	T = 10°

(m-M)	Driver	Price
3KIT.350.1L (1-1)	on/off	€ 21,00
3KIT.351.40 (1-3)	DALI - Push - 1...10V	€ 105,00
Remote installation		
3KIT.352.15 (1-1)	DALI	€ 59,00
3KIT.353.15 (1-1)	Push - 1...10V	€ 59,00
3KIT.354.18 (1-1)	IGBT - TRIAC	€ 32,00

Emergency unit: (inverter + battery. Driver not included)		
3KIT.900.01 (1-1)	1:00 hour/ora	€ 95,00
3KIT.900.03 (1-1)	3:00 hours/ore	€ 137,00

Housing for plasterboard ↻ Ø 14,0cm

●	1Z00.120.01	Single	€ 46,00
●●	1Z00.120.2L	Double	€ 88,00
●●●	1Z00.120.3L	Triple	€ 125,00

Housing for brickwork

●	1M00.120.01		€ 111,00
---	-------------	--	----------

(m-M) = min. Led unit - Max Led unit.
Led and Emergency unit, warranty only when used together with driver bought from Oty srl.

Pop P12 Ø 12,5 trimless (for plasterboard and brickwork)

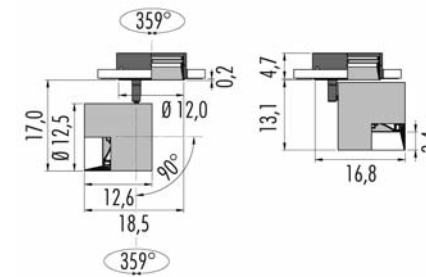

IP20	CE	V	⊕
12V			
3P12.530.□	G53	max 50W	€ 193,00
3KIT.201.050		max 50VA	€ 32,00
Dimmable gear: IGBT			

Frame	Color
02	Black
06	White

IP40	MC-E=3	CE	V	⊕
350 - 500 - 700 m/A				CRI>90
3P12.6.■M.□			€ 260,00	

(m-M)	LED 12,5W	350m/A
3KIT.350.1L (1-1)	on/off	€ 21,00
3KIT.351.40 (1-3)	DALI - Push - 1...10V	€ 105,00
3KIT.352.15 (1-1)	DALI	€ 59,00
3KIT.353.15 (1-1)	Push - 1...10V	€ 59,00
3KIT.354.18 (1-1)	IGBT - TRIAC	€ 32,00

Led color	Nominal lm	Beam spread
2 = 2700°K	1477	L = 60°
3 = 3000°K	1565	S = 24°
4 = 4000°K	1635	T = 12°

(m-M)	LED 18,4W	500m/A
3KIT.500.1L (1-1)	on/off	€ 21,00
3KIT.501.50 (1-3)	DALI - Push - 1...10V	€ 105,00
3KIT.502.20 (1-1)	DALI	€ 59,00
3KIT.503.20 (1-1)	Push - 1...10V	€ 59,00
3KIT.504.20 (1-1)	IGBT - TRIAC	€ 32,00

Led color	Nominal lm	Beam spread
2 = 2700°K	2020	L = 60°
3 = 3000°K	2140	S = 24°
4 = 4000°K	2236	T = 12°

(m-M)	LED 27W	700m/A
3KIT.700.1L (1-1)	on/off	€ 24,00
3KIT.701.50 (1-1)	DALI - Push - 1...10V	€ 105,00
Led color	Nominal lm	Beam spread
2 = 2700°K	2683	L = 60°
3 = 3000°K	2842	S = 24°
4 = 4000°K	2963	T = 12°

Housing for plasterboard ↻ Ø 14,0cm

●	1Z00.120.01	Single	€ 46,00
●●	1Z00.120.2L	Double	€ 88,00
●●●	1Z00.120.3L	Triple	€ 125,00

Housing for brickwork

●	1M00.120.01		€ 111,00
---	-------------	--	----------

(m-M) = min. Led unit - Max Led unit.
Led and Emergency unit, warranty only when used together with driver bought from Oty srl.

Pop 12 Ring \varnothing 3,0 recessed (only for plasterboard)



IP20	MC-E=3	CE
500 m/A	6W	CRI>90
3PR12.2 S.□		€ 230,00
4PR12.2 S.□		€ 236,00
<i>With honeycomb</i>		
■ Led color	Nominal lm	Beam spread
2 = 2700°K	528	S = 24°
3 = 3000°K	552	
4 = 4000°K	594	

© (m-M)	Driver	
3KIT.500.15 (1-1)	on/off	€ 27,00
3KIT.501.50 (1-7)	DALI - Push - 1...10V	€ 105,00
	<i>Remote installation</i>	
3KIT.502.20 (1-3)	DALI	€ 59,00
3KIT.503.20 (1-3)	Push - 1...10	€ 59,00
3KIT.504.10 (1-1)	IGBT - TRIAC	€ 32,00

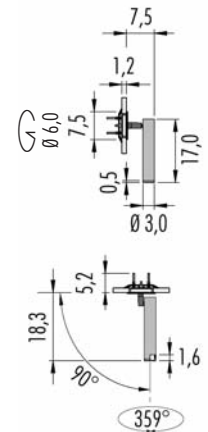

□	Frame	Ring
02	● Black	● Black
06	○ White	○ White
KC	● Black	● Copper Anodized
KS	● Black	● Brass Anodized
WC	○ White	○ Copper Anodized
WS	○ White	○ Brass Anodized

Time delivery: 15 Working Days

Pop 12 Cup \varnothing 3,0 wall/ceiling



IP20	MC-E=3	CE
500 m/A	6W	CRI>90
3PC12.2 S.□		€ 250,00
4PC12.2 S.□		€ 256,00
<i>With honeycomb</i>		
■ Led color	Nominal lm	Beam spread
2 = 2700°K	528	S = 24°
3 = 3000°K	552	
4 = 4000°K	594	

© (m-M)	Driver	<i>ONLY in remote installation</i>
3KIT.500.15 (1-1)	on/off	€ 27,00
3KIT.501.50 (1-7)	DALI - Push - 1...10V	€ 105,00
3KIT.502.20 (1-3)	DALI	€ 59,00
3KIT.503.20 (1-3)	Push - 1...10	€ 59,00
3KIT.504.10 (1-1)	IGBT - TRIAC	€ 32,00

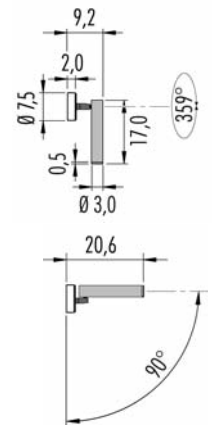

□	Frame	Ring
02	● Black	● Black
06	○ White	○ White
KC	● Black	● Copper Anodized
KS	● Black	● Brass Anodized
WC	○ White	○ Copper Anodized
WS	○ White	○ Brass Anodized

Time delivery: 15 Working Days

Pop 12 Ring \varnothing 6,0 recessed (only for plasterboard)



IP20	MC-E=3	CE
350m/A	11W	CRI>90
3PR12.3		€ 230,00
4PR12.3		€ 236,00

With honeycomb, only for S (22°) and T (10°)

Led color	Nominal lm	Beam spread
2 = 2700°K	1195	M = 38°
3 = 3000°K	1257	S = 22°
4 = 4000°K	1313	T = 10°

© (m-M)	Driver	
3KIT.350.1L (1-1)	on/off	€ 21,00
3KIT.351.40 (1-3)	DALI - Push - 1...10V Remote installation	€ 105,00
3KIT.352.15 (1-1)	DALI	€ 59,00
3KIT.353.15 (1-1)	Push - 1...10V	€ 59,00
3KIT.354.18 (1-1)	IGBT - TRIAC	€ 32,00

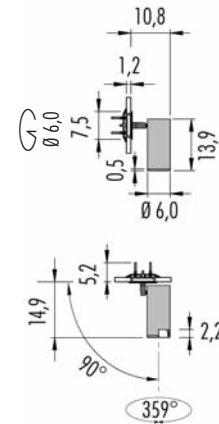

□	Frame	Ring
02	Black	Black
06	White	White
KC	Black	Copper Anodized
KS	Black	Brass Anodized
WC	White	Copper Anodized
WS	White	Brass Anodized

Time delivery: 15 Working Days

Pop 12 Cup \varnothing 6,0 wall/ceiling



IP20	MC-E=3	CE
350m/A	11W	CRI>90
3PC12.3		€ 250,00
4PC12.3		€ 256,00

With honeycomb, only for S (22°) and T (10°)

Led color	Nominal lm	Beam spread
2 = 2700°K	1195	M = 38°
3 = 3000°K	1257	S = 22°
4 = 4000°K	1313	T = 10°

© (m-M)	Driver	ONLY in remote installation
3KIT.350.1L (1-1)	on/off	€ 21,00
3KIT.351.40 (1-3)	DALI - Push - 1...10V	€ 105,00
3KIT.352.15 (1-1)	DALI	€ 59,00
3KIT.353.15 (1-1)	Push - 1...10V	€ 59,00
3KIT.354.18 (1-1)	IGBT - TRIAC	€ 32,00

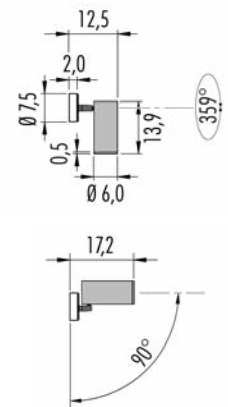

□	Frame	Ring
02	Black	Black
06	White	White
KC	Black	Copper Anodized
KS	Black	Brass Anodized
WC	White	Copper Anodized
WS	White	Brass Anodized

Time delivery: 15 Working Days

Pop 12 Ring \varnothing 12,0 recessed (only for plasterboard)

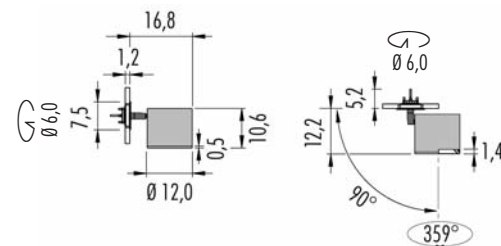

□	Frame	Ring
02	● Black	● Black
06	○ White	○ White
KC	● Black	● Copper Anodized
KS	● Black	● Brass Anodized
WC	○ White	○ Copper Anodized
WS	○ White	○ Brass Anodized

Time delivery: 15 Working Days

IP40	MC-E=3	CE
350 - 500 - 700 m/A		CRI>90
3PR12.6		€ 325,00

Driver ONLY in remote installation

© (m-M)	LED 12,5W	350m/A
3KIT.350.1L (1-1)	on/off	€ 21,00
3KIT.351.40 (1-3)	DALI - Push - 1...10V	€ 105,00
3KIT.352.15 (1-1)	DALI	€ 59,00
3KIT.353.15 (1-1)	Push - 1...10V	€ 59,00
3KIT.354.18 (1-1)	IGBT - TRIAC	€ 32,00

■ Led color	Nominal lm	▲ Beam spread
2 = 2700°K	1578	L = 60°
3 = 3000°K	1669	S = 24°
4 = 4000°K	1740	T = 12°

© (m-M)	LED 18,4W	500m/A
3KIT.500.1L (1-1)	on/off	€ 21,00
3KIT.501.50 (1-3)	DALI - Push - 1...10V	€ 105,00
3KIT.502.20 (1-1)	DALI	€ 59,00
3KIT.503.20 (1-1)	Push - 1...10V	€ 59,00
3KIT.504.20 (1-1)	IGBT - TRIAC	€ 32,00

■ Led color	Nominal lm	▲ Beam spread
2 = 2700°K	2176	L = 60°
3 = 3000°K	2301	S = 24°
4 = 4000°K	2400	T = 12°

© (m-M)	LED 27W	700m/A
3KIT.700.1L (1-1)	on/off	€ 24,00
3KIT.701.50 (1-1)	DALI - Push - 1...10V	€ 105,00

■ Led color	Nominal lm	▲ Beam spread
2 = 2700°K	2914	L = 60°
3 = 3000°K	3081	S = 24°
4 = 4000°K	3213	T = 12°

(m-M) = min. Led unit - Max Led unit.
Led and Emergency unit, warranty only when used
together with driver bought from Oty srl.

Pop 12 Cup \varnothing 12,0 wall/ceiling

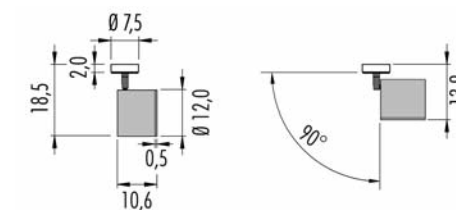

□	Frame	Ring
02	● Black	● Black
06	○ White	○ White
KC	● Black	● Copper Anodized
KS	● Black	● Brass Anodized
WC	○ White	○ Copper Anodized
WS	○ White	○ Brass Anodized

Time delivery: 15 Working Days

IP40	MC-E=3	CE
350 - 500 - 700 m/A		CRI>90
3PC12.6		€ 335,00

Driver ONLY in remote installation

© (m-M)	LED 12,5W	350m/A
3KIT.350.1L (1-1)	on/off	€ 21,00
3KIT.351.40 (1-3)	DALI - Push - 1...10V	€ 105,00
3KIT.352.15 (1-1)	DALI	€ 59,00
3KIT.353.15 (1-1)	Push - 1...10V	€ 59,00
3KIT.354.18 (1-1)	IGBT - TRIAC	€ 32,00

■ Led color	Nominal lm	▲ Beam spread
2 = 2700°K	1578	L = 60°
3 = 3000°K	1669	S = 24°
4 = 4000°K	1740	T = 12°

© (m-M)	LED 18,4W	500m/A
3KIT.500.1L (1-1)	on/off	€ 21,00
3KIT.501.50 (1-3)	DALI - Push - 1...10V	€ 105,00
3KIT.502.20 (1-1)	DALI	€ 59,00
3KIT.503.20 (1-1)	Push - 1...10V	€ 59,00
3KIT.504.20 (1-1)	IGBT - TRIAC	€ 32,00

■ Led color	Nominal lm	▲ Beam spread
2 = 2700°K	2176	L = 60°
3 = 3000°K	2301	S = 24°
4 = 4000°K	2400	T = 12°

© (m-M)	LED 27W	700m/A
3KIT.700.1L (1-1)	on/off	€ 24,00
3KIT.701.50 (1-1)	DALI - Push - 1...10V	€ 105,00

■ Led color	Nominal lm	▲ Beam spread
2 = 2700°K	2914	L = 60°
3 = 3000°K	3081	S = 24°
4 = 4000°K	3213	T = 12°

(m-M) = min. Led unit - Max Led unit.
Led and Emergency unit, warranty only when used
together with driver bought from Oty srl.

Polifemo PF1

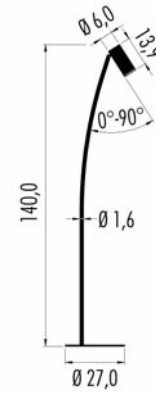

IP20	MC-E=3	CE
100-240V	11W CRI>90	dimmable
3PF1.3	S.□	€ 500,00
4PF1.3	S.□	€ 506,00
With honeycomb		
■ Led color	Nominal lm	Beam spread
2 = 2700°K	1195	22°
3 = 3000°K	1257	
4 = 4000°K	1313	

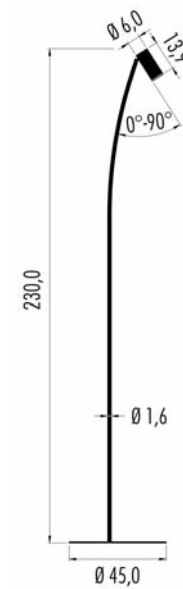

IP20	MC-E=3	CE
100-240V	11W CRI>90	dimmable
3PF2.3	S.□	€ 650,00
4PF2.3	S.□	€ 656,00
With honeycomb		
■ Led color	Nominal lm	Beam spread
2 = 2700°K	1195	22°
3 = 3000°K	1257	
4 = 4000°K	1313	

□	Frame	Ring
KC	● Black	● Copper Anodized
KS	● Black	● Brass Anodized
WC	○ White	● Copper Anodized
WS	○ White	● Brass Anodized

Time delivery: 25 Working days

Polifemo PF2

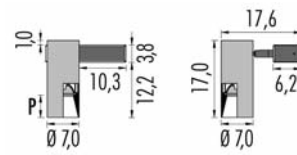

Pop 13 $\varnothing 7,0$ wall/ceiling

<input type="checkbox"/>	Frame
02	Black
06	White

IP20		CE	
220-240V	GU10 1x50W	P=5,0	
3P13.210.	<input type="checkbox"/>	€ 255,00	

IP20		CE	
220-240V	GU5.3 1x50W	P=5,0	
3P13.220.	<input type="checkbox"/>	€ 273,00	

IP20		CE		MC-E=3
220-240V	11W	CRI>90		
3P13.3		IGBT Triac	€ 354,00	
4P13.3		IGBT Triac	€ 360,00	

With honeycomb

3P13A3		DALI	€ 370,00	
4P13A3		DALI	€ 376,00	

With honeycomb

3P13G3		Push - 1...10V	€ 370,00	
4P13G3		Push - 1...10V	€ 376,00	

With honeycomb

■ Led color	Nominal lm	▲ Beam spread
2 = 2700°K	1119	M = 38° (P=0,5)
3 = 3000°K	1257	S = 22° (P=5,0)
4 = 4000°K	1313	T = 10° (P=0,5)

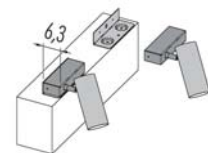

Installation kit on beams and horizontal surfaces

1KIT.P136.	<input type="checkbox"/>	€ 24,00
------------	--------------------------	---------

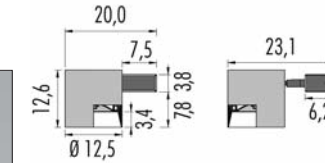
Pop 13 $\varnothing 12,5$ wall/ceiling

<input type="checkbox"/>	Frame
02	Black
06	White

IP20		CE	
220-240V	G53 1x50W		
3P13.530.	<input type="checkbox"/>	€ 289,00	

IP20		CE		MC-E=3
220-240V	12,5W	CRI>90		
3P13.4		IGBT Triac	€ 360,00	
3P13A4		DALI	€ 430,00	
3P13G4		Push - 1...10V	€ 430,00	

■ Led color	Nominal lm	▲ Beam spread
2 = 2700°K	1477	L = 60°
3 = 3000°K	1565	S = 24°
4 = 4000°K	1635	T = 12°

IP20		CE		MC-E=3
220-240V	18,5W	CRI>90		
3P13.5		IGBT Triac	€ 360,00	
3P13A5		DALI	€ 430,00	
3P13G5		Push - 1...10V	€ 430,00	

■ Led color	Nominal lm	▲ Beam spread
2 = 2700°K	2020	L = 60°
3 = 3000°K	2140	S = 24°
4 = 4000°K	2236	T = 12°

IP20		CE		MC-E=3
220-240V	27W	CRI>90		
3P13.6		on/off	€ 360,00	
3P13E6		DALI - Push	€ 430,00	
3P13C6		1...10V	€ 430,00	

■ Led color	Nominal lm	▲ Beam spread
2 = 2700°K	2683	L = 60°
3 = 3000°K	2842	S = 24°
4 = 4000°K	2963	T = 12°

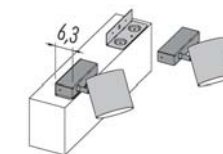

Installation kit on beams and horizontal surfaces

1KIT.P136.	<input type="checkbox"/>	€ 24,00
------------	--------------------------	---------

Pop 14 Ø 3,0 for 230 voltage 3~ circuit Eutrac

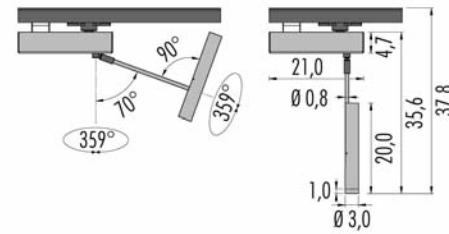

- Frame
- 02 ● Black
- 06 ○ White

IP20	CE	MC-E=3
220-240V	13,4W	CRI>90
3P14.2 ■ M. □	on/off	€ 310,00 ▼
4P14.2 ■ M. □	on/off	€ 316,00 ▼
<i>With honeycomb</i>		
Led color	Nominal lm	Beam spread
2 = 2700 °K	1650	35°
3 = 3000 °K	1727	
4 = 4000 °K	1786	

Pop 14 Ø 7,0 for 230 voltage 3~ circuit Eutrac

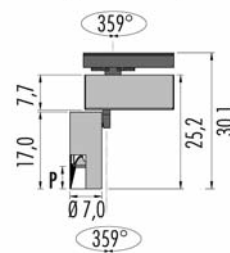

- Frame
- 02 ● Black
- 06 ○ White

IP20	CE	MC-E=3
220-240V	11W	CRI>90
3P14.220. □	on/off	€ 295,00 ▼
<i>With honeycomb</i>		
Led color	Nominal lm	Beam spread
2 = 2700 °K	1119	M = 38° (P=0,5)
3 = 3000 °K	1257	S = 22° (P=5,0)
4 = 4000 °K	1313	T = 10° (P=0,5)

Pop 14 Ø 12,5 for 230 voltage 3~ circuit Eutrac



- Frame
- 02 ● Black
- 06 ○ White

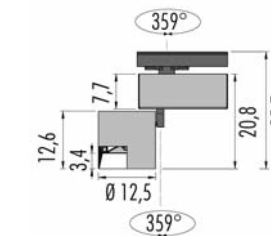

IP20	CE	MC-E=3
220-240V	18,5W	CRI>90
3P14.530. □	on/off	€ 305,00 ▼
<i>With honeycomb</i>		
Led color	Nominal lm	Beam spread
2 = 2700 °K	2020	L = 60°
3 = 3000 °K	2140	S = 24°
4 = 4000 °K	2236	T = 12°

IP20	CE	MC-E=3
220-240V	27W	CRI>90
3P14.6 ■ M. □	on/off	€ 379,00 ▼
<i>With honeycomb</i>		
Led color	Nominal lm	Beam spread
2 = 2700 °K	2683	L = 60°
3 = 3000 °K	2842	S = 24°
4 = 4000 °K	2963	T = 12°

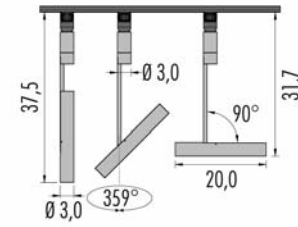
Pop 15 \varnothing 3,0 for 48V track Eutrac

IP20	CE	MC-E=3
48V	13,4W	CRI>90
3P15.2	M.□ on/off	€ 230,00
4P15.2	M.□ on/off	€ 236,00
With honeycomb		
■ Led color	Nominal lm	▲ Beam spread
2 = 2700°K	1650	35°
3 = 3000°K	1727	
4 = 4000°K	1786	

Ⓢ Electronic Gear in remote position
Dimmable on demand

3KIT.048.120	on/off 0 ~ 5A	€ 83,00
3KIT.048.240	on/off 0 ~ 10A	€ 170,00

□	Frame
02 ●	Black
06 ○	White

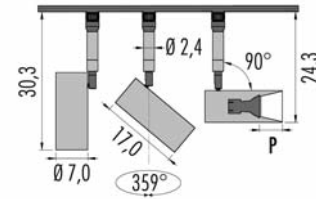
Pop 15 \varnothing 7,0 for 48V track Eutrac

IP20	CE	MC-E=3
48V	11W	CRI>90
3P15.3	M.□ on/off	€ 285,00
4P15.3	M.□ on/off	€ 291,00
With honeycomb		
■ Led color	Nominal lm	▲ Beam spread
2 = 2700°K	1119	M = 38° (P=0,5)
3 = 3000°K	1257	S = 22° (P=5,0)
4 = 4000°K	1313	T = 10° (P=0,5)

Ⓢ Electronic Gear in remote position
Dimmable on demand

3KIT.048.120	on/off 0 ~ 5A	€ 83,00
3KIT.048.240	on/off 0 ~ 10A	€ 170,00

□	Frame
02 ●	Black
06 ○	White

Pop 15 \varnothing 12,5 for 48V track Eutrac

IP20	CE	MC-E=3
48V	18,5W	CRI>90
3P15.5	M.□ on/off	€ 319,00
■ Led color	Nominal lm	▲ Beam spread
2 = 2700°K	2020	L = 60°
3 = 3000°K	2140	S = 24°
4 = 4000°K	2236	T = 12°

IP20	CE	MC-E=3
48V	27W	CRI>90
3P15.6	M.□ on/off	€ 319,00
■ Led color	Nominal lm	▲ Beam spread
2 = 2700°K	2683	L = 60°
3 = 3000°K	2842	S = 24°
4 = 4000°K	2963	T = 12°

Ⓢ Electronic Gear in remote position
Dimmable on demand

3KIT.048.120	on/off 0 ~ 5A	€ 83,00
3KIT.048.240	on/off 0 ~ 10A	€ 170,00

□	Frame
02 ●	Black
06 ○	White

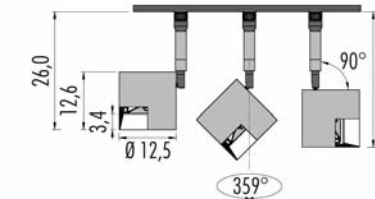

Pop P16 Pull 16,0 h. for 230 voltage 3~ circuit Eutrac



- Frame
- 02 ● Black
- 06 ○ White

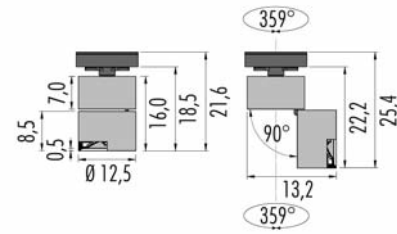

IP20 ©	CE ▼ MC-E-3	
220-240V	18,5W	
3P16P.5	IGBT Triac	
■ Led color	Nominal lm	▲ Beam spread
2 = 2700 °K	2683	L = 60°
3 = 3000 °K	2842	S = 24°
4 = 4000 °K	2963	T = 12°

Pop P16 Pull 21,0 h. for 230 voltage 3~ circuit Eutrac



- Frame
- 02 ● Black
- 06 ○ White

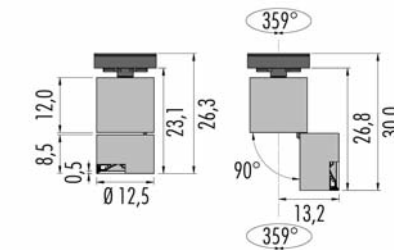

IP20 ©	CE ▼ MC-E-3	
220-240V	653 1x50W	
3P16P.530	€ 302,00 ▼	
IP20 ©	CE ▼ MC-E-3	
220-240V	23W	
3P16P.6	on/off	
■ Led color	Nominal lm	▲ Beam spread
2 = 2700 °K	2228	L = 60°
3 = 3000 °K	2357	S = 24°
4 = 4000 °K	2455	T = 12°

Lighting track 230V 3-CCT and accessories

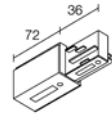
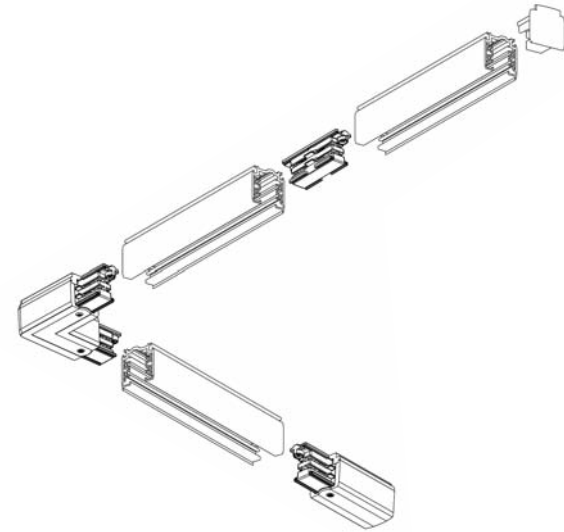
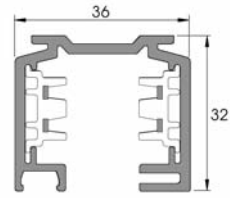

Supply connector earth conductor on right
 1R-555112011 White € 31,00
 1R-555112012 Black € 31,00

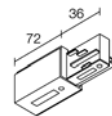

Supply connector earth conductor on left
 1R-555112021 White € 31,00
 1R-555112022 Black € 31,00

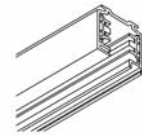

Lighting track 3-CCT aluminium
 length 1000 mm
 1R-25101 White € 74,00
 1R-25102 Black € 74,00

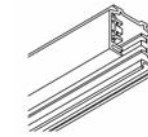

Lighting track 3-CCT aluminium
 length 2000 mm
 1R-25201 White € 125,00
 1R-25202 Black € 125,00

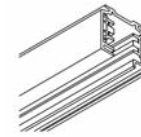

Lighting track 3-CCT aluminium
 length 3000 mm
 1R-25301 White € 185,00
 1R-25302 Black € 185,00

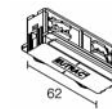

Concealed coupling with wiring
 1R-555112061 White € 19,00
 1R-555112062 Black € 19,00

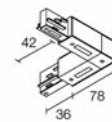

L-shaped coupling ground external
 1R-555112091 White € 64,00
 1R-555112092 Black € 64,00

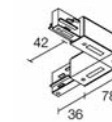

L-shaped coupling ground internal
 1R-555112101 White € 64,00
 1R-555112102 Black € 64,00

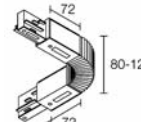

Flexible coupling
 1R-555112111 White € 95,00
 1R-555112112 Black € 95,00

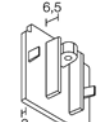

End cap
 1R-555012171 White € 3,50
 1R-555012172 Black € 3,50

Low-voltage Led track 48V and accessories

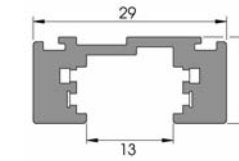

Supply connector earth conductor on right
 1R-556242011 White € 56,00
 1R-556242012 Black € 56,00

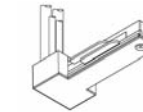

Supply connector earth conductor on left
 1R-556242021 White € 56,00
 1R-556242022 Black € 56,00

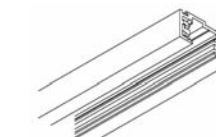

Lighting track aluminium
 length 2000 mm
 1R-556241021 White € 134,00
 1R-556241022 Black € 134,00



Lighting track aluminium
 length 3000 mm
 1R-556241031 White € 190,00
 1R-556241032 Black € 190,00

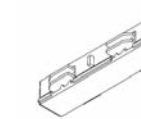

Straight coupler
 1R-556242061 White € 19,00
 1R-556242062 Black € 19,00

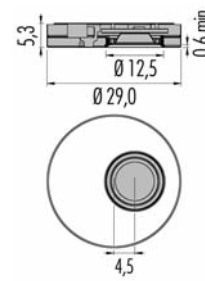

End cap
 1R-556042171 White € 4,50
 1R-556042172 Black € 4,50

Pop P30 Sun Static 

IP20	©	CE	MC-E=3
220-240V	18,1W	CRI>90	
3P30S.6	L. □	IGBT Triac	€ 332,00
3P30SA6	L. □	DALI	€ 365,00
3P30SG6	L. □	Push - 1...10V	€ 365,00
■ Led color	Nominal lm	▲ Beam spread	
2 = 2700°K	2494	60°	
3 = 3000°K	2611		
4 = 4000°K	2697		

□	Frame
02 ●	Black
06 ○	White

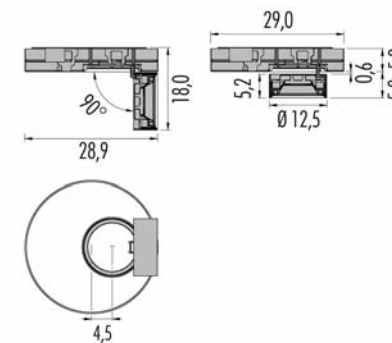
Pop P30 Sun Pull 

IP20	©	CE	MC-E=3
220-240V	12,3W	CRI>90	
3P30P.5	▲▲. □	IGBT Triac	€ 461,00
3P30PA5	▲▲. □	DALI	€ 500,00
3P30PG5	▲▲. □	Push - 1...10V	€ 500,00
■ Led color	Nominal lm	▲ Beam spread	
2 = 2700°K	1792	L = 80°	
3 = 3000°K	1876	M = 32°	
4 = 4000°K	1938	S = 24°	

□	Frame
02 ●	Black
06 ○	White

Pop Host Ø 32,0 mono-color **New**

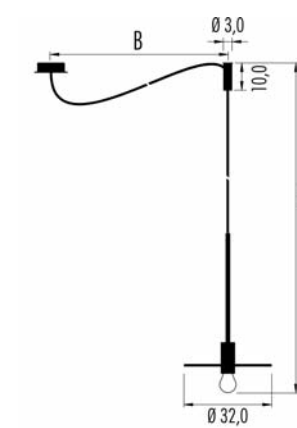
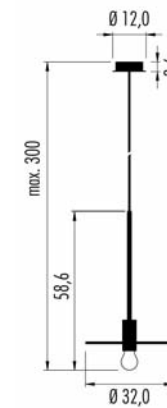

IP20	Ⓛ	CE	▽
220-240V	e27 7W	CRI>80	
3H32C.12L.□	dimm. IGBT - Triac	€ 360,00	
Led color	Nominal lm	Beam spread	
2700 °K	806	180°	

IP20	Ⓛ	CE	▽
220-240V	e27 7W	CRI>80	
3H32D.12L.□	dimm. IGBT - Triac	€ 385,00	
Led color	Nominal lm	Beam spread	
2700 °K	806	180°	

□	Frame	Bulb	CUP canopy	cable
06	○ White	● Mirror Chrome	White	White

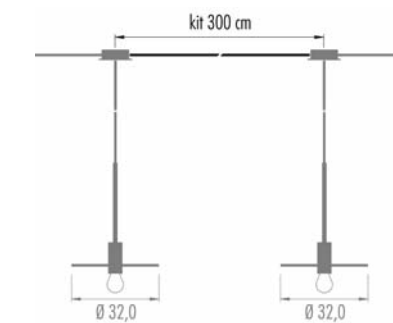

Kit Cable for Host composition: H32C			
1KIT.300.06	White	€ 36,00	

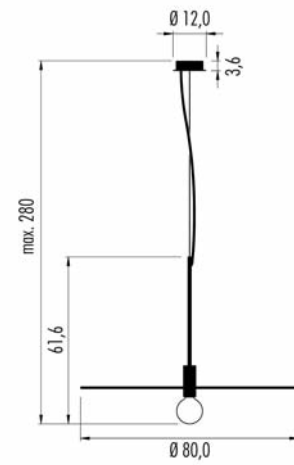

IP20	Ⓛ	CE	▽
220-240V	e27 7W	CRI>80	
3H80C.12L.	□	dim. IGBT - Triac	€ 570,00
Led color	Nominal lm	Beam spread	
2700°K	806	180°	

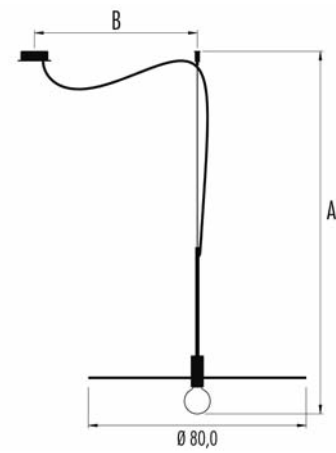

IP20	Ⓛ	A+B=390cm	CE	▽
220-240V	e27 7W	CRI>80		
3H80D.12L.	□	dim. IGBT - Triac	€ 610,00	
Led color	Nominal lm	Beam spread		
2700°K	806	180°		

□	Frame	Bulb	CUP canopy	cable
06	○ White	○ Mirror Chrome	○ White	○ White

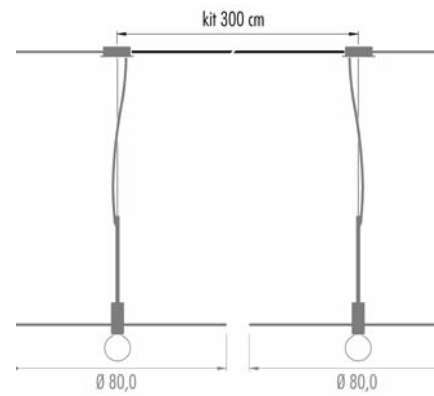

Kit Cable for Host composition: H80C

1KIT.300.06	White	€ 36,00
--------------------	-------	---------

Pop Host Ø 80,0 mono-color *New*



Pop Host Ø 32,0 bi-color

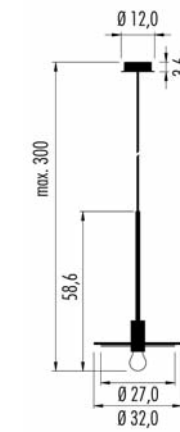

IP20	Ⓛ	CE	▽
220-240V	e27 7W	CRI>80	
3H32C.12L.	IGBT - Triac	€ 500,00	
Led color	Nominal lm	Beam spread	
2700 °K	806	180°	

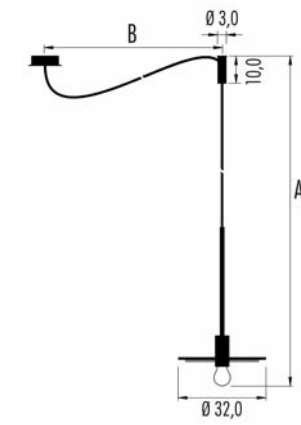

IP20	Ⓛ	A+B=390cm	CE	▽
220-240V	e27 7W	CRI>80		
3H32D.12L.	IGBT - Triac	€ 590,00		
Led color	Nominal lm	Beam spread		
2700 °K	806	180°		

	Up	Down	Canopy	cable	Bulb	
KS	●	●	Black/Brass	Black	Brass	● Mirror Brass
WS	●	●	White/Brass	White	Brass	● Mirror Brass
BS	●	●	Blue/Brass	Blue	Brass	● Mirror Brass
GS	●	●	Green/Brass	Green	Brass	● Mirror Brass
PS	●	●	Rose/Brass	Rose	Brass	● Mirror Brass
RS	●	●	Red/Brass	Red	Brass	● Mirror Brass

Time delivery: 25 Working Days

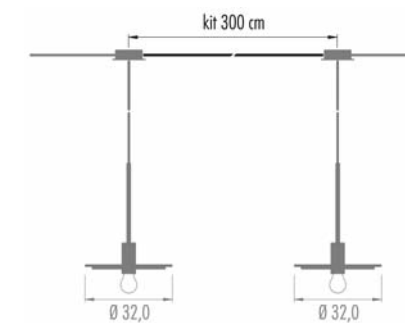

Kit Cable for Host composition: H32C		
1KIT.300.S	Brass	€ 65,00

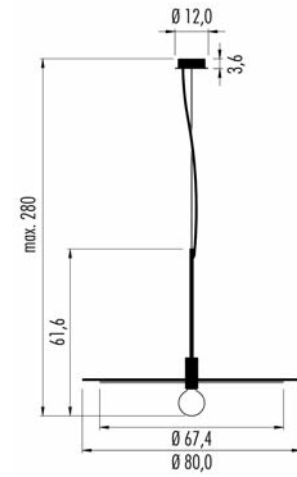

IP20	Ⓛ	CE	▽
220-240V	e27 7W	CRI>80	
3H80C.12L.	IGBT - Triac	€ 1.230,00	
Led color	Nominal lm	Beam spread	
2700 °K	806	180°	

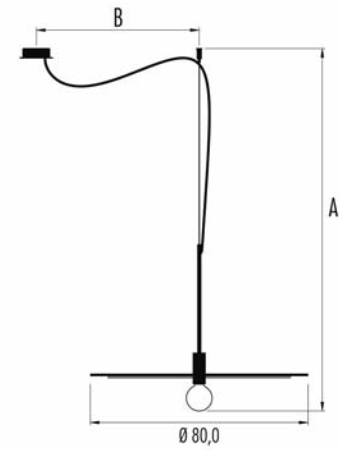

IP20	Ⓛ	A+B=390cm	CE	▽
220-240V	e27 7W	CRI>80		
3H80D.12L.	IGBT - Triac	€ 1.265,00		
Led color	Nominal lm	Beam spread		
2700 °K	806	180°		

	Up	Down	Diffuser color	CUP	cabl	Bulb
KS	●	●	Black/Brass	Black	Brass	Mirror Brass
WS	○	●	White/Brass	White	Brass	Mirror Brass
BS	●	●	Blue/Brass	Blue	Brass	Mirror Brass
GS	●	●	Green/Brass	Green	Brass	Mirror Brass
PS	●	●	Rose/Brass	Rose	Brass	Mirror Brass
RS	●	●	Red/Brass	Red	Brass	Mirror Brass

Time delivery: 25 Working Days

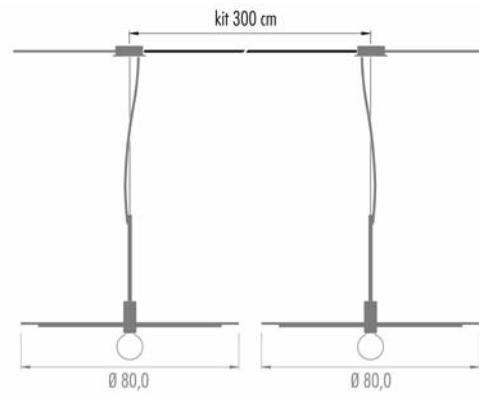

Kit Cable for Host composition: H80C		
1KIT.300.S	Brass	€ 65,00

Pop Host Ø 80,0 bi-color



Pop Host - W - wall/ceiling bi-color

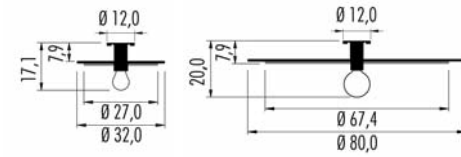

IP20	Ⓢ	CE	∇
220-240V	ø27 7W CRI>80	IGBT - Triac	
3H32W.12L.□	Ø 32cm	€ 355,00	
3H80W.12L.□	Ø 80cm	€ 1.050,00	
Led color	Nominal lm	Beam spread	
2700°K	806	180°	

□	Up	Down	Diffuser color	Bulb
KS	●	●	Black/Brass	● Mirror Brass
WS	○	●	White/Brass	● Mirror Brass
BS	●	●	Blue/Brass	● Mirror Brass
GS	●	●	Green/Brass	● Mirror Brass
PS	●	●	Rose/Brass	● Mirror Brass
RS	●	●	Red/Brass	● Mirror Brass

Time delivery: 25 Working Days



Pop Host L/M-T/N bi-color

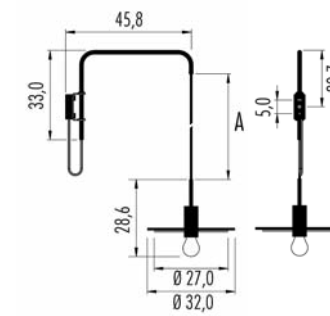

IP20	Ⓛ	A= max. 140cm	CE	▽
220-240V		e27 7W	CRI>80	
3H32N.12L.	□	dim. IGBT - Triac	€ 650,00	
Led color		Nominal lm	Beam spread	
2700 °K		806	180°	

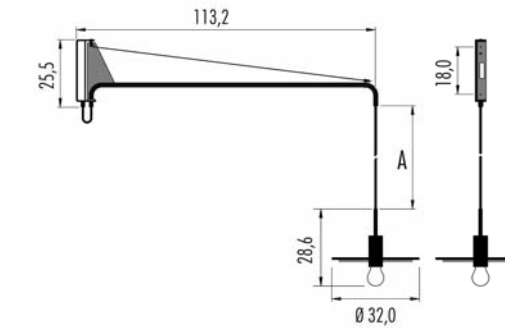

IP20	Ⓛ	A= max. 130cm	CE	▽
220-240V		e27 7W	CRI>80	
3H32M.12L.	□	dim. IGBT - Triac	€ 900,00	
Led color		Nominal lm	Beam spread	
2700 °K		806	180°	

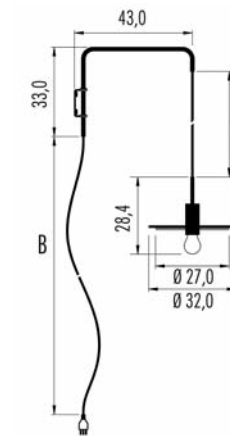

IP20	Ⓛ	A+B=360cm	CE	▽
220-240V		e27 7W	CRI>80	
3H32T.12L.	□	dim. IGBT - Triac	€ 620,00	
Led color		Nominal lm	Beam spread	
2700 °K		806	180°	

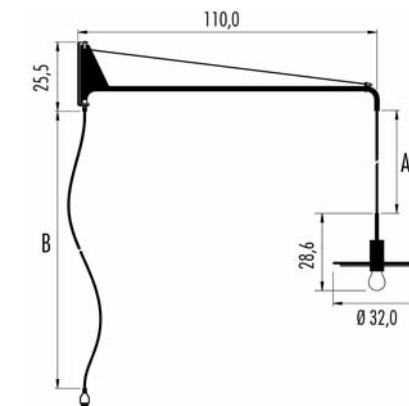

IP20	Ⓛ	A+B=300cm	CE	▽
220-240V		e27 7W	CRI>80	
3H32L.12L.	□	dim. IGBT - Triac	€ 850,00	
Led color		Nominal lm	Beam spread	
2700 °K		806	180°	

	Up	Down	Diffuser color	Bulb
KS	●	●	Black/Brass	● Mirror Brass
WS	○	●	White/Brass	● Mirror Brass
BS	●	●	Blue/Brass	● Mirror Brass
GS	●	●	Green/Brass	● Mirror Brass
PS	●	●	Rose/Brass	● Mirror Brass
RS	●	●	Red/Brass	● Mirror Brass

Time delivery: 25 Working Days

Pop P40 Chandelier

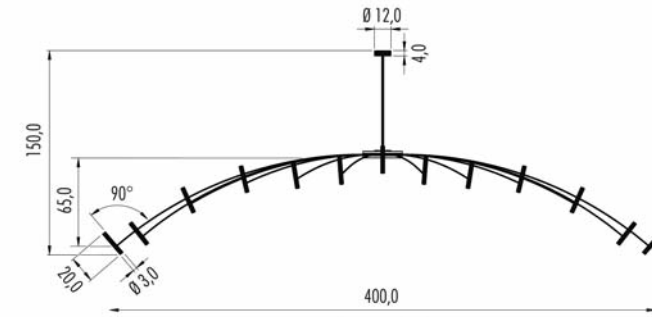

IP20	MC-E=3	CE	∇
220-240V	24x13,4W	CRI>90	
3P40A.2 M.02		€ 7.800,00	
3P40A.2 M.06		€ 7.800,00	
3P40A.2 M.B		€ 8.800,00	
3P40A.2 M.C		€ 9.000,00	
3P40A.2 M.G		€ 8.800,00	
3P40A.2 M.P		€ 8.800,00	
3P40A.2 M.R		€ 8.800,00	

Led color	Nominal lm	Beam spread
2 = 2700 °K	24 x 1650	M = 35°
3 = 3000 °K	24 x 1727	

3DRV.024.DIM DALI - Push - 1...10V € 91,00
Remote installation: need 2 units

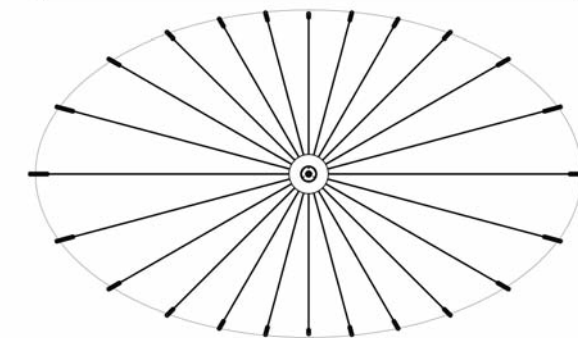

IP20	MC-E=3	CE	∇
220-240V	24x13,4W	CRI>90	
3P40B.2 M.02		€ 6.600,00	
3P40B.2 M.06		€ 6.600,00	
3P40B.2 M.B		€ 7.600,00	
3P40B.2 M.C		€ 7.800,00	
3P40B.2 M.G		€ 7.600,00	
3P40B.2 M.P		€ 7.600,00	
3P40B.2 M.R		€ 7.600,00	

Led color	Nominal lm	Beam spread
2 = 2700 °K	24 x 1650	M = 35°
3 = 3000 °K	24 x 1727	

3DRV.024.DIM DALI - Push - 1...10V € 91,00
Remote installation: need 2 units

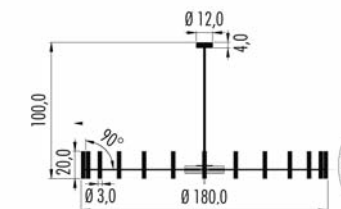

IP20	MC-E=3	CE	∇
220-240V	24x13,4W	CRI>90	
3P40R.2 M.02		€ 6.600,00	
3P40R.2 M.06		€ 6.600,00	
3P40R.2 M.B		€ 7.600,00	
3P40R.2 M.C		€ 7.800,00	
3P40R.2 M.G		€ 7.600,00	
3P40R.2 M.P		€ 7.600,00	
3P40R.2 M.R		€ 7.600,00	

Led color	Nominal lm	Beam spread
2 = 2700 °K	24 x 1650	M = 35°
3 = 3000 °K	24 x 1727	

3DRV.024.DIM DALI - Push - 1...10V € 91,00
Remote installation: need 2 units

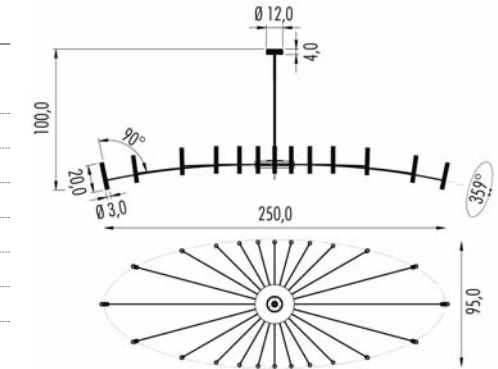

Ⓢ Two given electronic gears (remote installation) for double switching on (alternating mode).
Die zwei gegebenen Netzgeräte (separat einzubauen) einstellen die Doppelzündung der Strahler (abwechselnd).
Les deux transformateurs fournis (à positionner en retrait) commandent un double allumage des sources lumineuses (12 d'une part, 12 d'autre part).
Los dos transformadores suministrados (a instalar de forma remota) permiten el doble encendido de la lámpara (cuyos brazos lo hacen de manera alterna).

- Free of Tax
- Frame
- 02 ● Black
 - 06 ○ White
 - B ● Blue
 - C ● Copper
 - G ● Green
 - P ● Rose
 - R ● Red
- Time delivery: 30 Working days

P50 Pinocchio

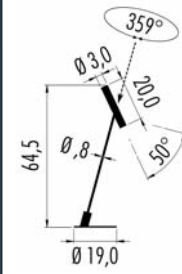

IP20 ©	MC-E=3	CE ▽
100-240V	6W CRI>90	dimmable
4P50.2 ■ M.02	With honeycomb	€ 410,00
4P50.2 ■ M.06	With honeycomb	€ 410,00
4P50.2 ■ M.B	With honeycomb	€ 480,00
4P50.2 ■ M.C	With honeycomb	€ 480,00
4P50.2 ■ M.G	With honeycomb	€ 480,00
4P50.2 ■ M.P	With honeycomb	€ 480,00
4P50.2 ■ M.R	With honeycomb	€ 480,00
■ Led color	Nominal lm	Beam spread
2 = 2700°K	824	35°
3 = 3000°K	861	
4 = 4000°K	888	

□ Frame

- 02 ● Black
- 06 ○ White
- B ● Blue
- C ● Copper
- G ● Green
- P ● Rose
- R ● Red

Time delivery: 25 Working days

P55 Pinocchio

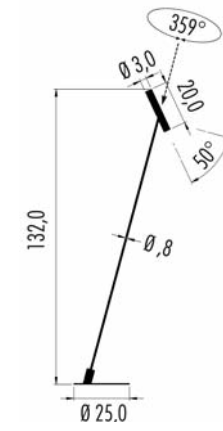

IP20 ©	MC-E=3	CE ▽
100-240V	6W CRI>90	dimmable
4P55.2 ■ M.02	With honeycomb	€ 500,00
4P55.2 ■ M.06	With honeycomb	€ 500,00
4P55.2 ■ M.B	With honeycomb	€ 560,00
4P55.2 ■ M.C	With honeycomb	€ 560,00
4P55.2 ■ M.G	With honeycomb	€ 560,00
4P55.2 ■ M.P	With honeycomb	€ 560,00
4P55.2 ■ M.R	With honeycomb	€ 560,00
■ Led color	Nominal lm	Beam spread
2 = 2700°K	824	35°
3 = 3000°K	861	
4 = 4000°K	888	

□ Frame

- 02 ● Black
- 06 ○ White
- B ● Blue
- C ● Copper
- G ● Green
- P ● Rose
- R ● Red

Time delivery: 25 Working days

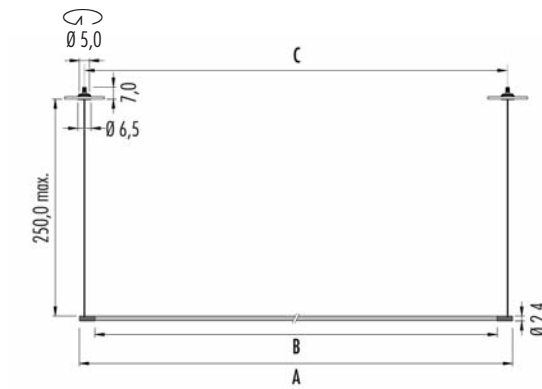

Pop P120 - P200

**Pop P120 ARC** recessed canopy for plasterboard ceiling

IP20

220-240V 26W CRI>85

3PA1.43L.□ € 707,00

A = 124cm B = 108,4cm C = 119cm

Led color	Nominal lm	Beam spread
3000°K	2350	106°

Pop P200 ARC recessed canopy for plasterboard ceiling

IP20

220-240V 43W CRI>85

3PA2.43L.□ € 1.050,00

A = 196cm B = 180,4cm C = 191cm

Led color	Nominal lm	Beam spread
3000°K	3915	106°

Electronic gear has to be placed in a remote position

3KIT.024.DIM Dimmable option:
DALI - Push - 1...10V € 91,00
Remote installation - need 1 unit to order

□	Frame	ARC canopy	CUP canopy	Cable
02	● Black	White	Black	Black
06	○ White	White	White	White

Time delivery: 25 Working Days

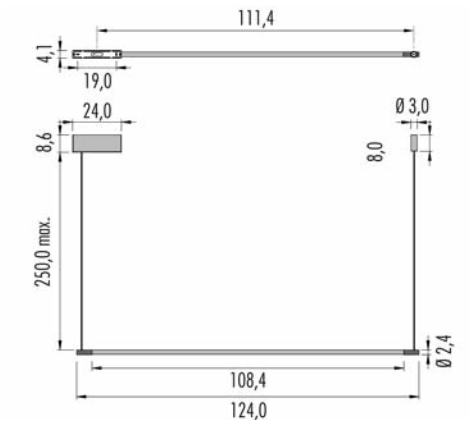
**Pop P120 CUP** external canopy

IP20

220-240V 26W CRI>85

3PC1.43L.□ on/off € 733,00

Led color	Nominal lm	Beam spread
3000°K	2350	106°

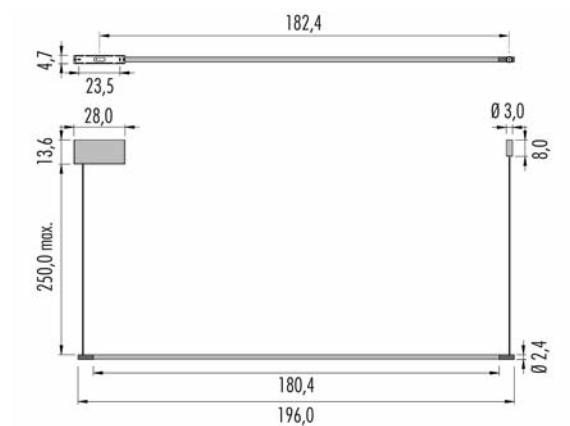
**Pop P200 CUP** external canopy

IP20

220-240V 43W CRI>85

3PC2.43L.□ on/off € 1.016,00

Led color	Nominal lm	Beam spread
3000°K	3915	106°

Pop P122 - P202 Brooklyn

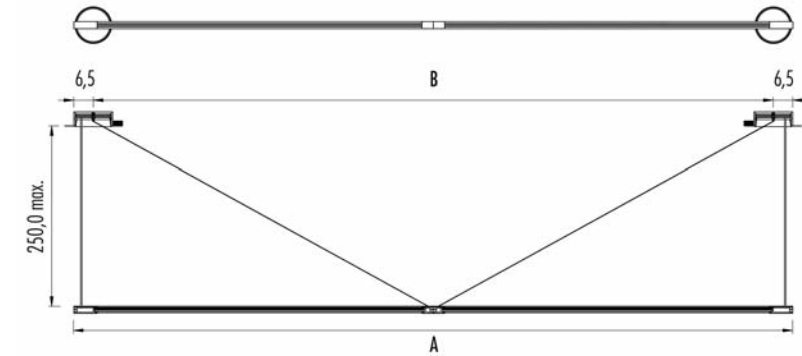
**Pop P122 ARC** recessed canopy for plasterboard ceiling

IP20	CE	V	Φ
220-240V	2x26W	CRI>85	
3P122.43L		€ 1.391,00	
A = 240cm B = 227cm			

Led color	Nominal lm	Beam spread
3000°K	2x2350	106°

3KIT.024.DIM Dimmable option:
DALI - Push - 1...10V € **91,00**
Remote installation - need 2 units to order

Pop P202 ARC recessed canopy for plasterboard ceiling

IP20	CE	V	Φ
220-240V	2x43W	CRI>85	
3P202.43L		€ 2.023,00	
A = 384cm B = 371cm			

Led color	Nominal lm	Beam spread
3000°K	2x3915	106°

3KIT.024.DIM Dimmable option:
DALI - Push - 1...10V € **91,00**
Remote installation - need 2 units to order

Housing for plasterboard Ø 14,0cm

1Z00.120.01 ● x2 € **46,00 each**

Housing for brickwork

1M00.120.01 ● x2 € **111,00 each**

	Frame	ARC canopy	CUP canopy	cable
02	Black	White	Black	Black
06	White	White	White	White

Time delivery: 25 Working Days

Pop P123 - P203

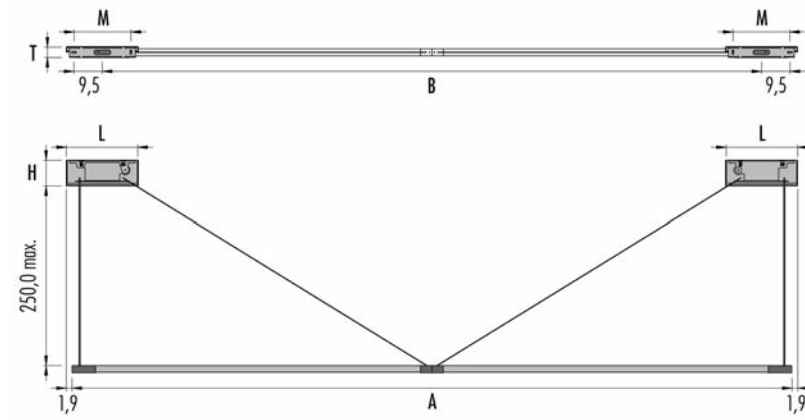
**Pop P123 CUP** external canopy

IP20	CE	V	⊕
220-240V	2x26W	CRI>85	
3P123.43L	□ on/off	€ 1.600,00	
A = 240cm	B = 219,8cm		
L = 24,0cm	H = 8,6cm	T = 4,1cm	M = 19,0cm
■ Led color	Nominal lm	Beam spread	
3000°K	2x2350	106°	

Pop P203 CUP external canopy

IP20	CE	V	⊕
220-240V	2x43W	CRI>85	
3P203.43L	□ on/off	€ 2.200,00	
A = 384cm	B = 363,8cm		
L = 28,0cm	H = 13,6cm	T = 4,7cm	M = 23,5cm
■ Led color	Nominal lm	Beam spread	
3000°K	2x3915	106°	

□	Frame	ARC canopy	CUP canopy	cable
02	● Black	White	Black	Black
06	○ White	White	White	White

Time delivery: 25 Working Days



Pop Up 1 wall

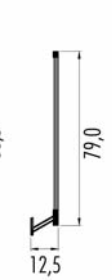
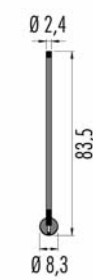

IP20	CE	on/off
220-240V	17W CRI>85	
3PU1.43L.02		€ 480,00
3PU1.43L.06		€ 480,00
3PU1.43L.CB		€ 530,00
3PU1.43L.CR		€ 530,00
Led color	Nominal lm	Beam spread
3 = 3000 °K	1794	L = 106°

Electronic gear has to be placed in a remote position

3KIT.024.DIM	Dimmable option: DALI - Push - 1...10V Remote installation	€ 91,00
--------------	--	---------

Frame	Plate
02 ● Black	● Black
06 ○ White	○ White
CB ● Copper	● Blue
CR ● Copper	● Red

Time delivery: 25 Working days

Pop Up 207

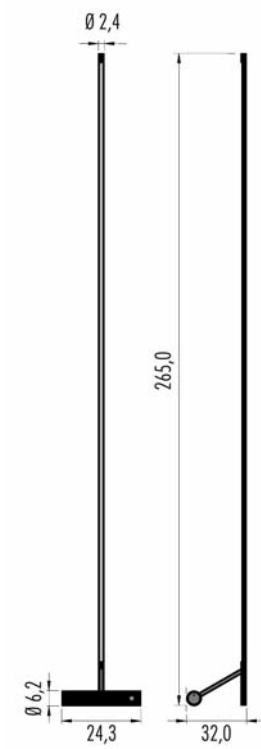

IP20	ⓘ	CE	▽
220-240V	58W	CRI>85	
3P207.A3L	□ on/off	€ 1.150,00	
✗ wired for switch controlled socket CEI 3-23			

Led color	Nominal lm	Beam spread
3000 °K	5285	106°

IP20	ⓘ	CE	▽
220-240V	58W	CRI>85	
3P207.B3L	□ on/off	€ 1.150,00	
Switch on power supply cable			

Led color	Nominal lm	Beam spread
3000 °K	5285	106°

□ Frame

02 ● Black

06 ○ White



Tim T01

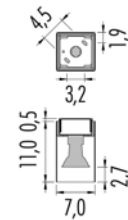
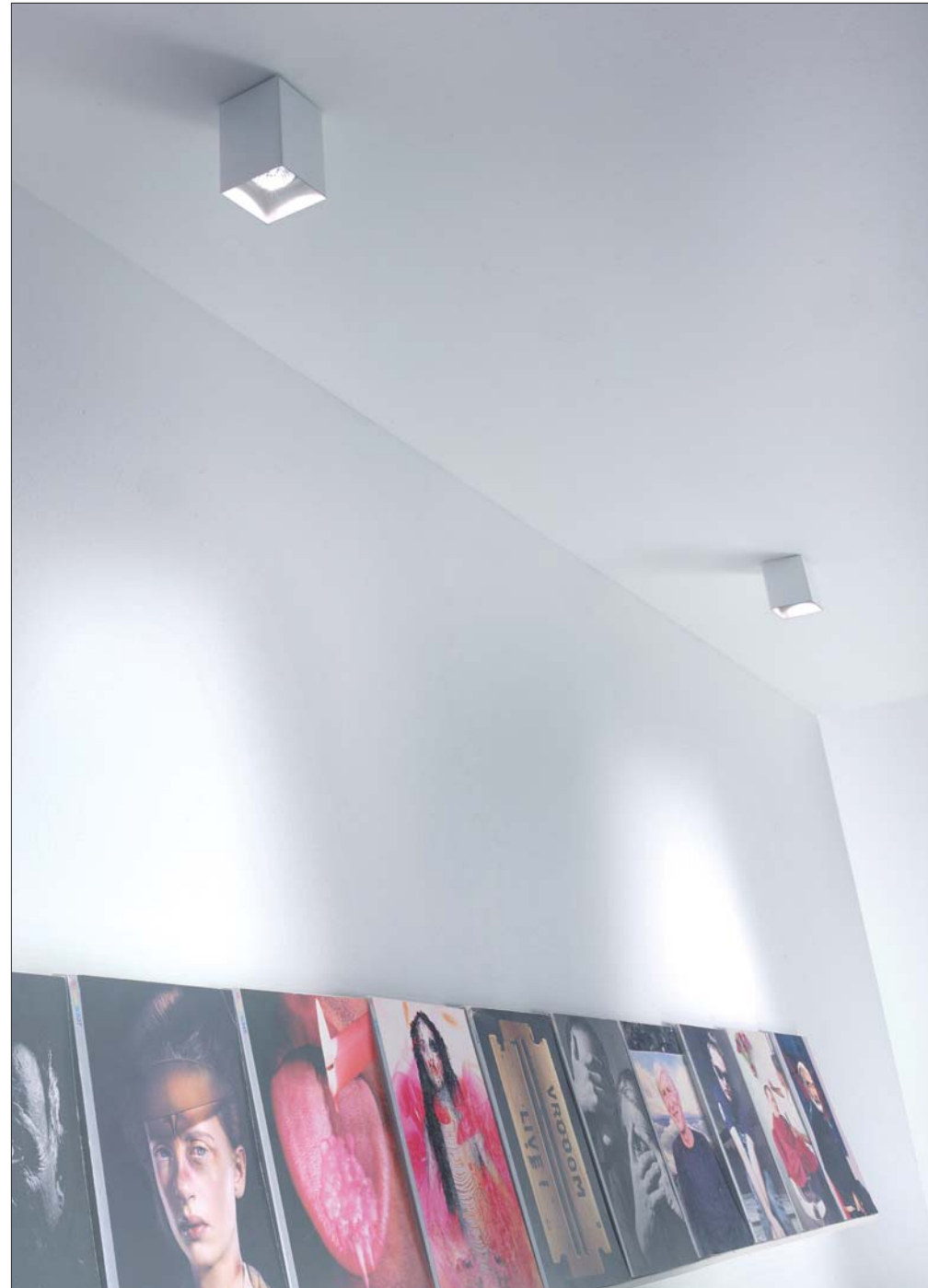

IP20	CE	▽
220-240V	GU10 max50W	
3T01.210.02		€ 113,00
3T01.210.04		€ 123,00
3T01.210.06		€ 113,00

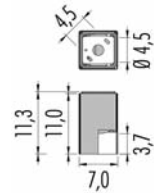

IP20	dimnable IGBT	CE	▽
220-240V	led 13W	CRI>85	
3T01.335.02		€ 209,00	
3T01.335.06		€ 209,00	
■ Led color	Nominal lm	Beam spread	
3000°K	1010	70°	

□ Frame

- 02 ● Black
- 04 ● Brushed steel
- 06 ● White

Tim T13

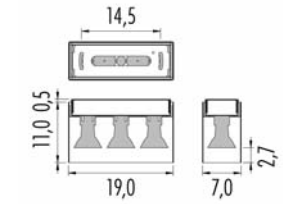

IP20	CE	▽
220-240V	GU10 max 3x50W	
3T13.210.02		€ 171,00
3T13.210.04		€ 216,00
3T13.210.06		€ 171,00

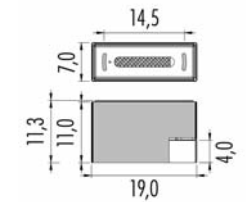

IP20	dimnable IGBT	CE	▽
220-240V	led 13W	CRI>85	
3T13.335.02		€ 257,00	
3T13.335.06		€ 257,00	
■ Led color	Nominal lm	Beam spread	
3000°K	1010	70°	

□ Frame

- 02 ● Black
- 04 ● Brushed steel
- 06 ● White

Tim T02

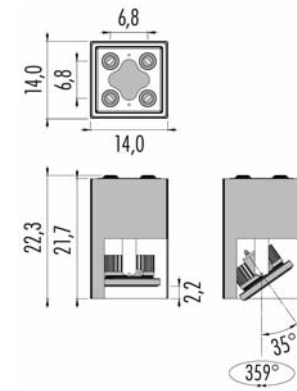

IP20	CE	MC-E=3
220-240V	27W	CR>90
3T02.6	on/off	€ 354,00
3T02A6	DALI	€ 370,00
3T02B6	Push	€ 370,00
3T02C6	1...10V	€ 370,00
Led color	Nominal lm	Beam spread
2 = 2700°K	2683	L = 60°
3 = 3000°K	2842	S = 24°
4 = 4000°K	2963	T = 12°
IP20	CE	MC-E=3
220-240V	653 lx50W	
3T02.535		€ 230,00

Frame
02 ● Black
06 ○ White

Tim T03

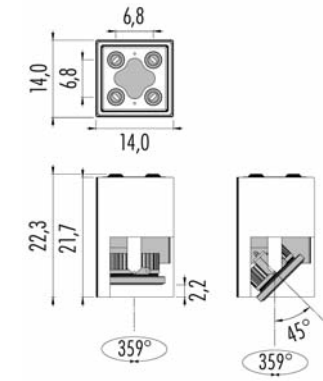
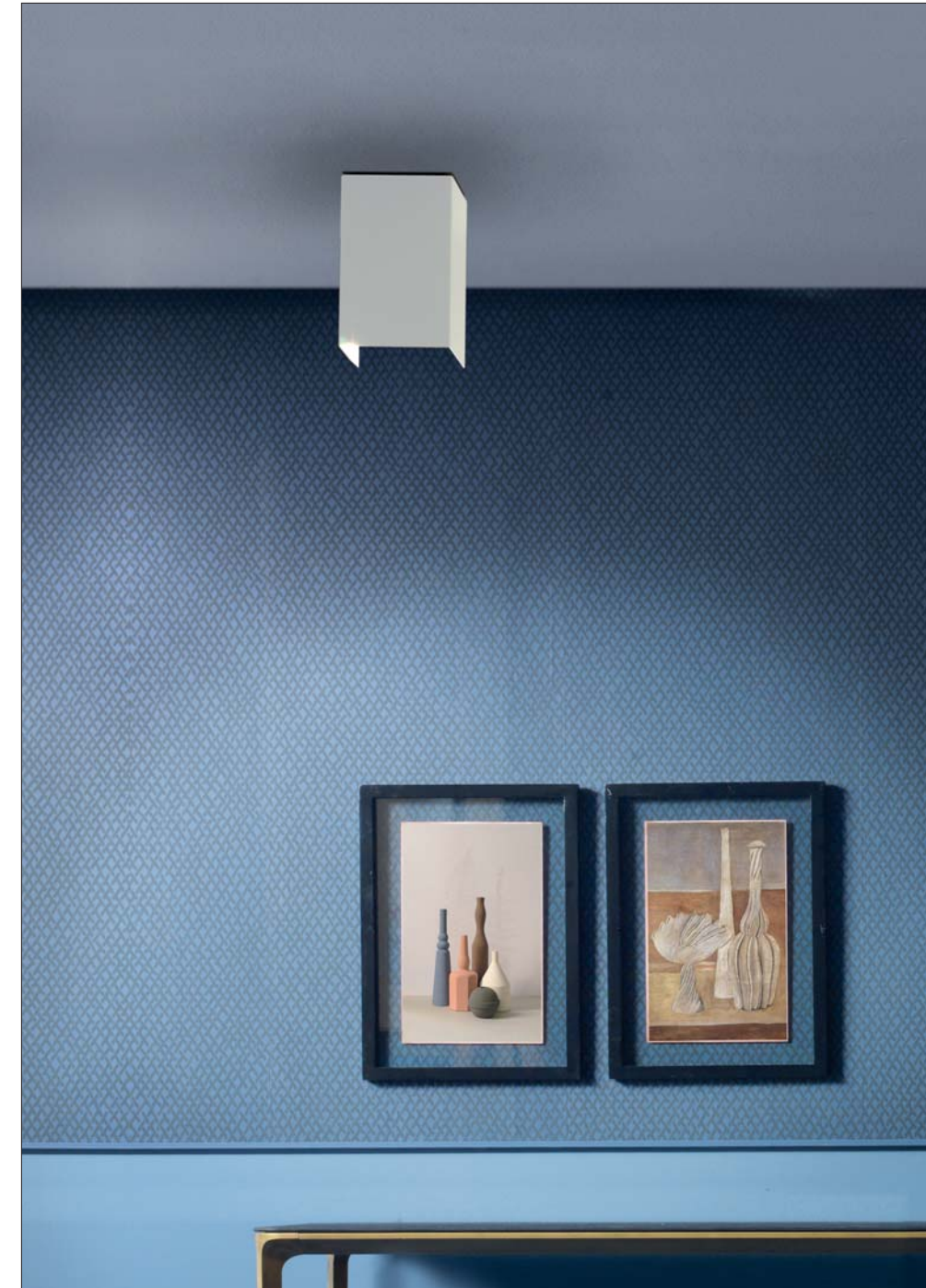

IP20	CE	MC-E=3
220-240V	27W	CR>90
3T03.6	on/off	€ 354,00
3T03A6	DALI	€ 370,00
3T03B6	Push	€ 370,00
3T03C6	1...10V	€ 370,00
Led color	Nominal lm	Beam spread
2 = 2700°K	2683	L = 60°
3 = 3000°K	2842	S = 24°
4 = 4000°K	2963	T = 12°
IP20	CE	MC-E=3
220-240V	653 lx50W	
3T03.535		€ 230,00

Frame
02 ● Black
06 ○ White

Tim T22

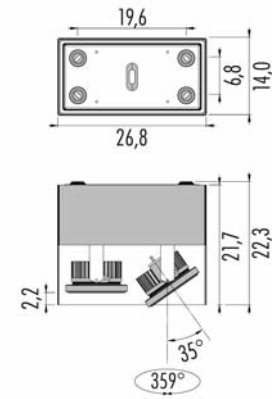

IP20	Ⓢ	CE	▽	MC-E=3
220-240V	2x27W	CRI>90		
3T22.6	on/off	€ 610,00		
3T22A6	DALI	€ 680,00		
3T22B6	Push	€ 680,00		
3T22C6	1...10V	€ 680,00		
■ Led color	Nominal lm	▲ Beam spread		
2 = 2700°K	2x2683	L = 60°		
3 = 3000°K	2x2842	S = 24°		
4 = 4000°K	2x2963	T = 12°		
IP20	Ⓢ	CE <td>▽</td> <td></td>	▽	
220-240V	653 2x50W			
3T22.535		€ 350,00	▼	

□	Frame
02 ●	Black
06 ○	White

Tim T32

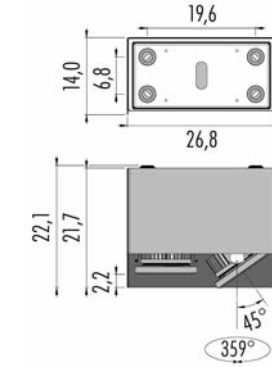

IP20	Ⓢ	CE	▽	MC-E=3
220-240V	2x27W	CRI>90		
3T32.6	on/off	€ 610,00		
3T32A6	DALI	€ 680,00		
3T32B6	Push	€ 680,00		
3T32C6	1...10V	€ 680,00		
■ Led color	Nominal lm	▲ Beam spread		
2 = 2700°K	2x2683	L = 60°		
3 = 3000°K	2x2842	S = 24°		
4 = 4000°K	2x2963	T = 12°		
IP20	Ⓢ	CE <td>▽</td> <td></td>	▽	
220-240V	653 2x50W			
3T32.535		€ 350,00	▼	

□	Frame
02 ●	Black
06 ○	White

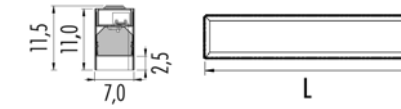
Tim T25 - T60 - T120 ROS

Tim T25

IP20	Ⓜ Ⓢ	L = 25,1cm	CE	▽	Ⓢ
220-240V		17W			CRI>85
3T25.63L.	□	on/off	€		279,00
■ Led color		Nominal lm			Beam spread
3000°K		2030			104°

Tim T60

IP20	Ⓜ Ⓢ	L = 60,1cm	CE	▽	Ⓢ
220-240V		34W			CRI>85
3T60.63L.	□	on/off	€		364,00
3T60A63L.	□	DALI	€		430,00
3T60G63L.	□	Push - 1...10V	€		430,00
■ Led color		Nominal lm			▲ Beam spread
3000°K		4120			104°

Tim T120

IP20	Ⓜ Ⓢ	L = 120,1cm	CE	▽	Ⓢ
220-240V		68W			CRI>85
3T120.63L.	□	on/off	€		568,00
3T120A63L.	□	DALI	€		620,00
3T120G63L.	□	Push - 1...10V	€		620,00
■ Led color		Nominal lm			▲ Beam spread
3000°K		8240			104°

□ Frame

02 ● Black

06 ○ White

Tim T124 - T196

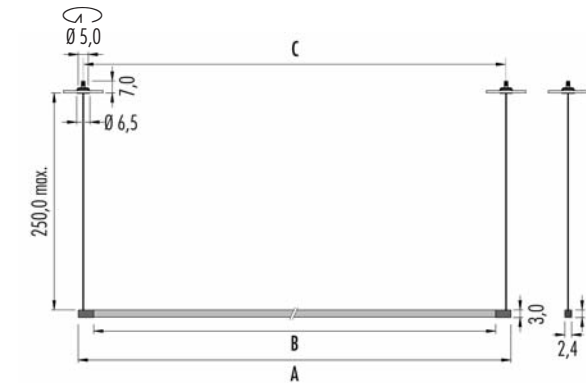

Tim T124 ARC recessed canopy for plasterboard ceiling
 IP20
 220-240V 2x26W CRI>85
3TA1.43L.□ € 835,00
 double switches up and down
 A = 124cm B = 108,4cm C = 119cm

Led color	Nominal lm	Beam spread
3000°K	2x2350	106°

Tim T196 ARC recessed canopy for plasterboard ceiling
 IP20
 220-240V 2x43W CRI>85
3TA2.43L.□ € 1.177,00
 double switches up and down
 A = 196cm B = 180,4cm C = 191cm

Led color	Nominal lm	Beam spread
3000°K	2x3915	106°

3KIT.024.DIM

Dimmable option:
 DALI - Push - 1...10V € 91,00
 Remote installation - need 2 unit to order

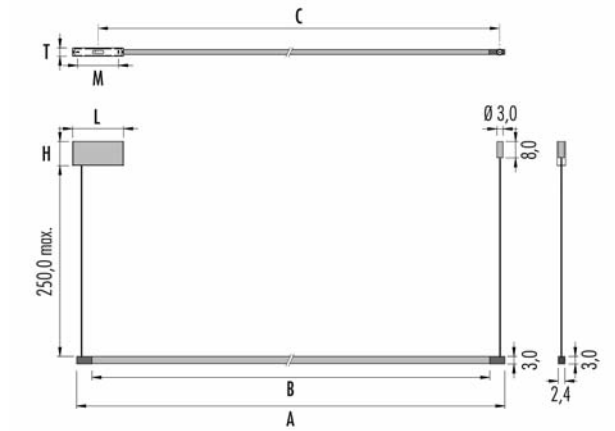

Tim T124 CUP external canopy
 IP20
 220-240V 2x26W CRI>85
3TC1.43L.□ € 835,00
 singular switch up and down - dimmable on request
 A = 124cm B = 108,4cm C = 110,4cm
 L = 24,0cm H = 8,6cm T = 4,1cm M = 19,0cm

Led color	Nominal lm	Beam spread
3000°K	2x2350	106°

Tim T196 CUP external canopy
 IP20
 220-240V 2x43W CRI>85
3TC2.43L.□ € 1.177,00
 singular switch up and down
 A = 196cm B = 180,4cm C = 182,4cm
 L = 28,0cm H = 13,6cm T = 4,7cm M = 23,5cm

Led color	Nominal lm	Beam spread
3000°K	2x3915	106°

□	Frame	ARC canopy	CUP canopy	cable
02	● Black	White	Black	Black
06	○ White	White	White	White

Time delivery: 25 Working Days

Wally 01 Dynamic Ø 12,5



□	Frame
02 ●	Black
06 ○	White

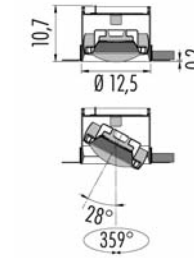

IP20	MC-E=3	CE
350 - 500 m/A		CRI>90
3W01D.5		€ 270,00

© (m-M)	LED 12,5W	350m/A
3KIT.350.1L (1-1)	on/off	€ 21,00
3KIT.351.40 (1-3)	DALI - Push - 1...10V	€ 105,00
3KIT.352.15 (1-1)	DALI	€ 59,00
3KIT.353.15 (1-1)	Push - 1...10V	€ 59,00
3KIT.354.18 (1-1)	IGBT - TRIAC	€ 32,00
■ Led color	Nominal lm	▲ Beam spread
2 = 2700 °K	1792	M = 50°
3 = 3000 °K	1876	S = 24°
4 = 4000 °K	1938	

© (m-M)	LED 18,4W	500m/A
3KIT.500.1L (1-1)	on/off	€ 21,00
3KIT.501.50 (1-3)	DALI - Push - 1...10V	€ 105,00
3KIT.502.20 (1-1)	DALI	€ 59,00
3KIT.503.20 (1-1)	Push - 1...10V	€ 59,00
3KIT.504.20 (1-1)	IGBT - TRIAC	€ 32,00
■ Led color	Nominal lm	▲ Beam spread
2 = 2700 °K	2494	M = 50°
3 = 3000 °K	2611	S = 24°
4 = 4000 °K	2697	

Emergency unit: (inverter + battery. Driver not included)

3KIT.900.01 (1-1)	1:00 hour/ora	€ 95,00
3KIT.900.03 (1-1)	3:00 hours/ore	€ 137,00

Housing for plasterboard  Ø 14,0cm

●	1Z00.125.01	Single	€ 40,00
●●	1Z00.125.2L	Double	€ 75,00
●●●	1Z00.125.3L	Triple 	€ 106,00

Housing for brickwork

●	1M00.125.01	€ 139,00
---	-------------	----------

(m-M) = min. Led unit - Max Led unit.
Led and Emergency unit, warranty only when used
together with driver bought from Oty srl.

Wally Ring Dynamic Ø 13,1



□ Frame

02 ● Black

06 ○ White

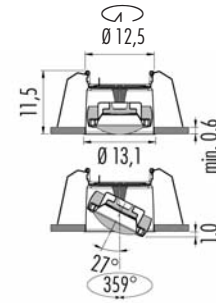

IP20	MC-E=3	CE	▽	⊕
350 - 500 m/A		CRI>90		
3WR1D.5		€ 288,00		

© (m-M)	LED 12,5W	350m/A
3KIT.350.1L (1-1)	on/off	€ 21,00
3KIT.351.40 (1-3)	DALI - Push - 1...10V	€ 105,00
3KIT.352.15 (1-1)	DALI	€ 59,00
3KIT.353.15 (1-1)	Push - 1...10V	€ 59,00
3KIT.354.18 (1-1)	IGBT - TRIAC	€ 32,00
■ Led color	Nominal lm	▲ Beam spread
2 = 2700°K	1792	M = 50°
3 = 3000°K	1876	S = 24°
4 = 4000°K	1938	

© (m-M)	LED 18,4W	500m/A
3KIT.500.1L (1-1)	on/off	€ 21,00
3KIT.501.50 (1-3)	DALI - Push - 1...10V	€ 105,00
3KIT.502.20 (1-1)	DALI	€ 59,00
3KIT.503.20 (1-1)	Push - 1...10V	€ 59,00
3KIT.504.20 (1-1)	IGBT - TRIAC	€ 32,00
■ Led color	Nominal lm	▲ Beam spread
2 = 2700°K	2494	M = 50°
3 = 3000°K	2611	S = 24°
4 = 4000°K	2697	

Emergency unit: (inverter + battery. Driver not included)

3KIT.900.01 (1-1)	1:00 hour/ora	€ 95,00
3KIT.900.03 (1-1)	3:00 hours/ore	€ 137,00

(m-M) = min. Led unit - Max Led unit.
Led and Emergency unit, warranty only when used
together with driver bought from Oty srl.

Wally Ring Pull Ø 12,5 cm



□ Frame

02 ● Black

06 ○ White

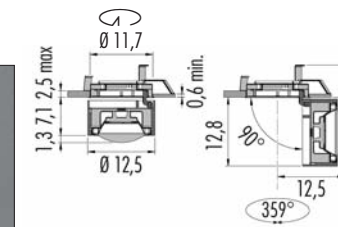

IP20	MC-E=3	CE	▽	⊕
350 - 500 m/A		CRI>90		
3WR1P.5		€ 330,00		

© (m-M)	LED 12,5W	350m/A
3KIT.350.1L (1-1)	on/off	€ 21,00
3KIT.351.40 (1-3)	DALI - Push - 1...10V	€ 105,00
3KIT.352.15 (1-1)	DALI	€ 59,00
3KIT.353.15 (1-1)	Push - 1...10V	€ 59,00
3KIT.354.18 (1-1)	IGBT - TRIAC	€ 32,00
■ Led color	Nominal lm	▲ Beam spread
2 = 2700°K	1792	M = 50°
3 = 3000°K	1876	S = 24°
4 = 4000°K	1938	

© (m-M)	LED 18,4W	500m/A
3KIT.500.1L (1-1)	on/off	€ 21,00
3KIT.501.50 (1-3)	DALI - Push - 1...10V	€ 105,00
3KIT.502.20 (1-1)	DALI	€ 59,00
3KIT.503.20 (1-1)	Push - 1...10V	€ 59,00
3KIT.504.20 (1-1)	IGBT - TRIAC	€ 32,00
■ Led color	Nominal lm	▲ Beam spread
2 = 2700°K	2494	M = 50°
3 = 3000°K	2611	S = 24°
4 = 4000°K	2697	

Emergency unit: (inverter + battery. Driver not included)

3KIT.900.01 (1-1)	1:00 hour/ora	€ 95,00
3KIT.900.03 (1-1)	3:00 hours/ore	€ 137,00

(m-M) = min. Led unit - Max Led unit.
Led and Emergency unit, warranty only when used
together with driver bought from Oty srl.

Wally 07 Pull Ø 12,5

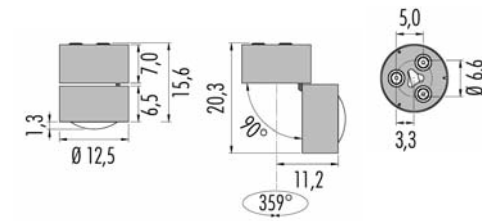

IP20	©	CE	MC-E=3
220-240V	18W	CRI>90	
3W07P.5	IGBT Triac	€ 430,00	
3W07PA5	DALI	€ 455,00	
3W07PG5	Push - 1...10V	€ 455,00	
■ Led color	Nominal lm	▲ Beam spread	
2 = 2700°K	1792	M = 50°	
3 = 3000°K	1876	S = 24°	
4 = 4000°K	1938		

□	Frame
02 ●	Black
06 ○	White

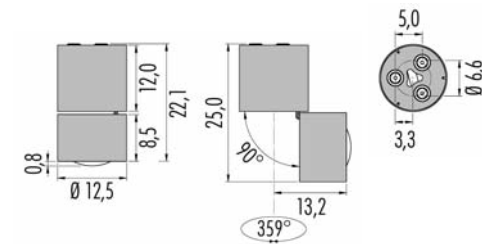

IP20	©	CE	MC-E=3
220-240V	26W	CRI>90	
3W07P.6	on/off	€ 430,00	
3W07PA6	DALI	€ 455,00	
3W07PG6	Push - 1...10V	€ 455,00	
■ Led color	Nominal lm	▲ Beam spread	
2 = 2700°K	3374	M = 50°	
3 = 3000°K	3533	S = 24°	
4 = 4000°K	3649		

Wally 16 Pull Ø 12,5 for 230 voltage 3 circuit Eutrac

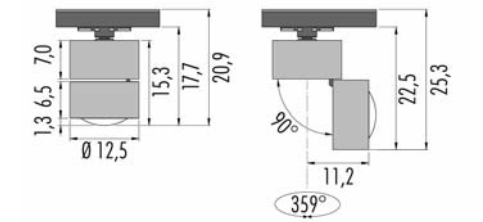

IP20	©	CE	MC-E=3
220-240V	18W	CRI>90	
3W16P.5	IGBT Triac	€ 319,00	
■ Led color	Nominal lm	▲ Beam spread	
2 = 2700°K	1792	M = 50°	
3 = 3000°K	1876	S = 24°	
4 = 4000°K	1938		

□	Frame
02 ●	Black
06 ○	White

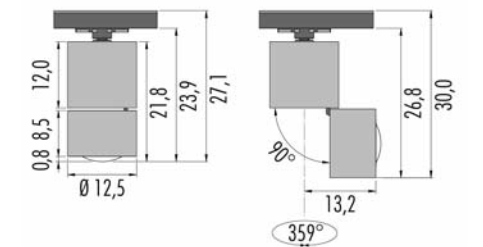

IP20	©	CE	MC-E=3
220-240V	26W	CRI>90	
3W16P.6	IGBT Triac	€ 430,00	
■ Led color	Nominal lm	▲ Beam spread	
2 = 2700°K	3374	M = 50°	
3 = 3000°K	3533	S = 24°	
4 = 4000°K	3649		

X-Running

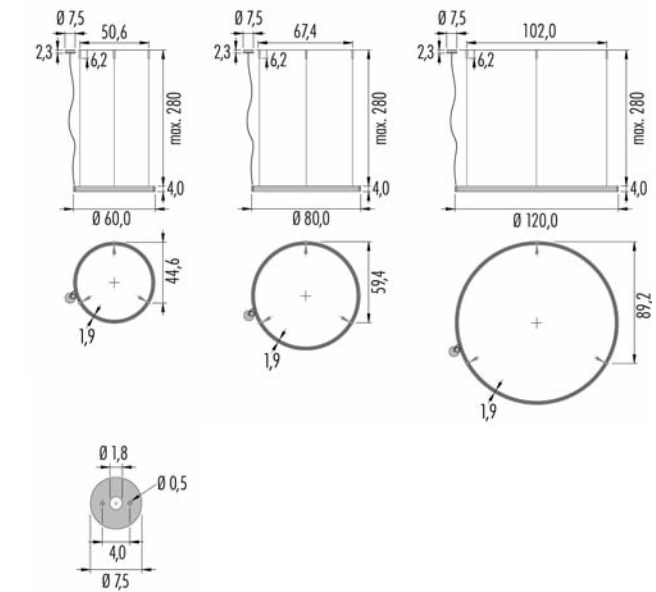
**R06 Ø 60,0***Electronic Gear in remote position*

IP40

24V 88W CRI>90

3R06.4 L. on/off € 1.100,00**Led color** *Nominal lm* *Beam spread*

2700 °K 6552 44°

3000 °K 7280

3KIT.E24.DIM *Dimmable option:*
DALI - Push - 1...10V € 70,00**R08 Ø 80,0***Electronic Gear in remote position*

IP40

24V 126W CRI>90

3R08.4 L. on/off € 1.350,00**Led color** *Nominal lm* *Beam spread*

2700 °K 9432 44°

3000 °K 10480

3KIT.E24.DIM *Dimmable option:*
DALI - Push - 1...10V € 70,00**R12 Ø 120,0***Electronic Gear in remote position*

IP40

24V 184W CRI>90

3R12.4 L. on/off € 1.700,00**Led color** *Nominal lm* *Beam spread*

2700 °K 13752 44°

3000 °K 15280

3KIT.E24.DIM *Dimmable option:*
DALI - Push - 1...10V € 70,00 *Frame***02** Black**06** White

Available from 15/10/2019

X-Running

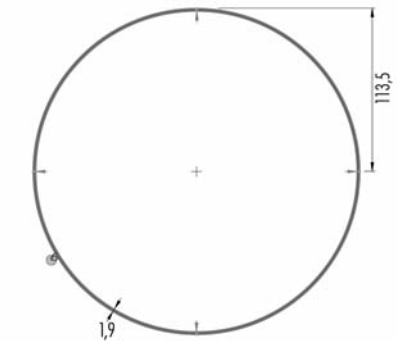
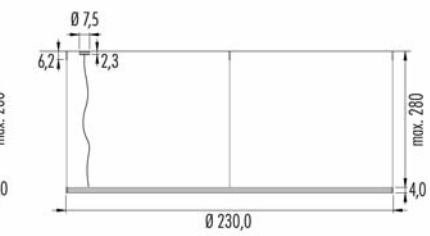
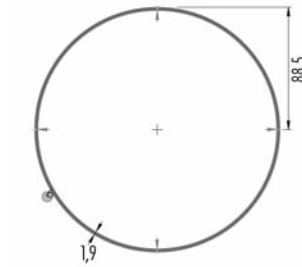
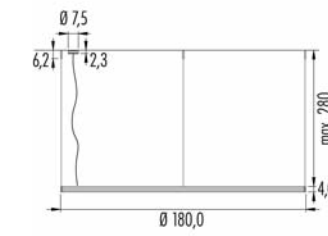
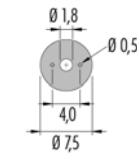

□ Frame

02 ● Black
06 ○ White

Available from 15/10/2019

R18 Ø 180,0	<i>Electronic Gear in remote position</i>	
IP40	Ⓢ	CE ⚡ ⚙
24V	270W	CRI>90
3R18.4	■ L □	on/off - 1...10V € 2.250,00
■ <i>Led color</i>	<i>Nominal lm</i>	<i>Beam spread</i>
2700 °K	20232	44°
3000 °K	22480	

3KIT.D24.DIM *Dimmable option:*
DALI - Push - 1...10V € **250,00**

R23 Ø 230,0	<i>Electronic Gear in remote position</i>	
IP40	Ⓢ	CE ⚡ ⚙
24V	347W	CRI>90
3R23.4	■ L □	on/off - 1...10V € 3.100,00
■ <i>Led color</i>	<i>Nominal lm</i>	<i>Beam spread</i>
2700 °K	26028	44°
3000 °K	28920	

3KIT.D24.DIM *Dimmable option:*
DALI - Push - 1...10V € **250,00**

Zip 90 ROS

- Frame
- 3 ● Aluminium painted
- 6 ○ White painted

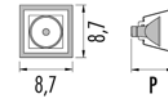

IP20	⊗	CE	▽	⊕
220V ÷ 240V		GU10	max 50W	
3ZIP90GU10	□	P = 8,0cm	€	52,00
IP20	⊗	CE	▽	⊕
12V		GU5.3	max 50W	
3ZIP90GU5.3	□	P = 8,0cm	€	49,00
3KIT.201.050		max 50VA	€	32,00
		dimnable gear: IGBT		

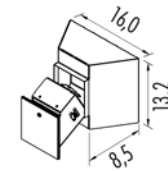

Housing for Brickwork **ONLY for ZIP 90 - ZIP 45**

1ZIP - Z	one unit	€	17,50
1ZIP - Zx10	ten units	€	157,50



Glass for ZIP 90 - ZIP 60 - ZIP 45

2ZIP - V	one unit	€	10,00
2ZIP - Vx10	ten units	€	90,00

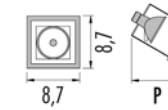
Zip 60 ROS

Zip 60 only for plasterboard

IP20	⊗	CE	▽	⊕
220V ÷ 240V		GU10	max 50W	
3ZIP60GU10	□	P = 9,5cm	€	56,00
IP20	⊗	CE	▽	⊕
12V		GU5.3	max 50W	
3ZIP60GU5.3	□	P = 8,5cm	€	54,00
3KIT.201.050		max 50VA	€	32,00
		dimnable gear: IGBT		

Appendix

- *Filo System: configurations and geometries*
- *Housings for plasterboard and brickwork*
- *Mounting instructions for housings*

Filo System: configurations

Example 1

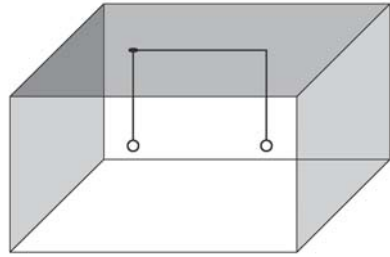

2 x Diffuser:
Bijou | C'est moi | C'est toi | Chérie | Petit | Chapeau | BonBon

1 x Canopy: CUP
1 x Kit: KIT.WM5.02

Example 2

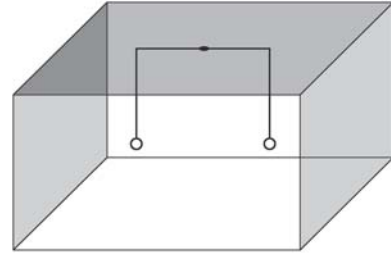

2 x Diffuser:
Bijou | C'est moi | C'est toi | Chérie | Petit | Chapeau | BonBon

1 x Canopy: CUP
1 x Kit: KIT.WM5.02

Example 3

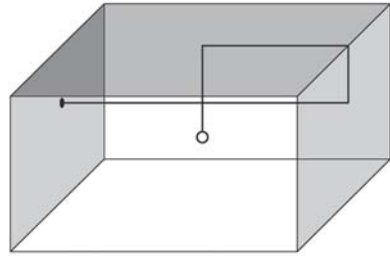

1 x Diffuser:
Bijou | C'est moi | C'est toi | Chérie | Petit | Chapeau | BonBon

1 x Canopy: ARC or CUP
1 x Kit: KIT.WM5.02

Example 4

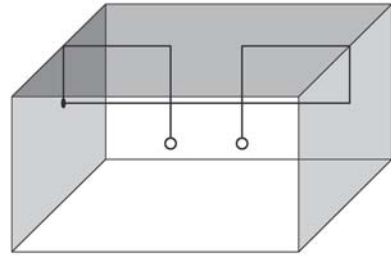

2 x Diffuser:
Bijou | C'est moi | C'est toi | Chérie | Petit | Chapeau | BonBon

1 x Canopy: CUP
1 x Kit: KIT.WM5.02

Example 5

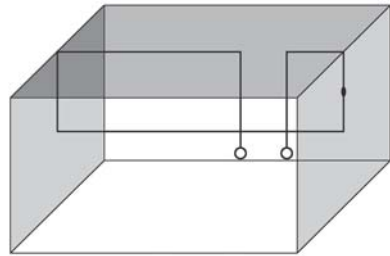

2 x Diffuser:
Bijou | C'est moi | C'est toi | Chérie | Petit | Chapeau | BonBon

1 x Canopy: CUP
1 x Kit: KIT.WM8.02

Example 6

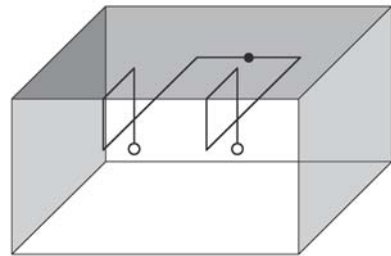

2 x Diffuser:
Bijou | C'est moi | C'est toi | Chérie | Petit | Chapeau | BonBon

1 x Canopy: CUP
1 x Kit: KIT.WM8.02

Example 7

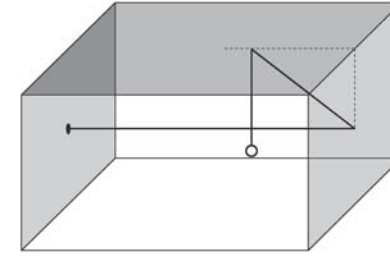

1 x Diffuser:
Bijou | C'est moi | C'est toi | Chérie | Petit | Chapeau | BonBon

1 x Canopy: ARC or CUP
1 x Kit: KIT.WM5.02

Example 8

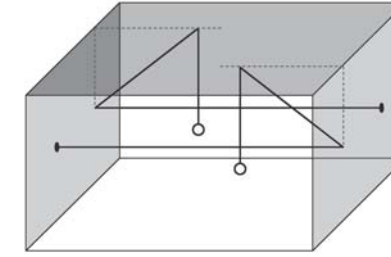

2 x Diffuser:
Bijou | C'est moi | C'est toi | Chérie | Petit | Chapeau | BonBon

2 x Canopy: ARC or CUP
1 x Kit: KIT.WM5.02

Example 9

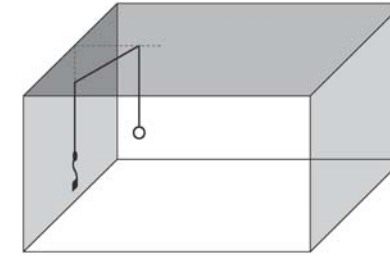

1 x Diffuser:
Bijou | C'est moi | C'est toi | Chérie | Petit | Chapeau | BonBon

1 x Canopy: CUP with Plug-in
1 x Kit: KIT.WM5.02

Example 10

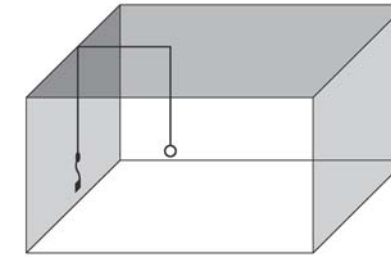

1 x Diffuser:
Bijou | C'est moi | C'est toi | Chérie | Petit | Chapeau | BonBon

1 x Canopy: CUP with Plug-in
1 x Kit: KIT.WM5.02

Example 11

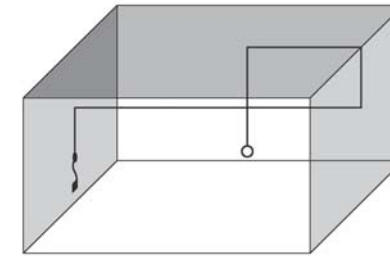

1 x Diffuser:
Bijou | C'est moi | C'est toi | Chérie | Petit | Chapeau | BonBon

1 x Canopy: CUP with Plug-in
1 x Kit: KIT.WM5.02

Example 12

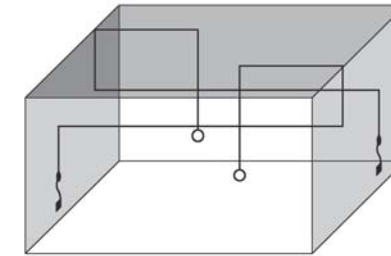

2 x Diffuser:
Bijou | C'est moi | C'est toi | Chérie | Petit | Chapeau | BonBon

2 x Canopy: CUP with Plug-in
1 x Kit: KIT.WM8.02

Filo System: wall geometries

1 x Diffuser:
Bijou | C'est moi | C'est toi | Chérie | Petit | Chapeau | BonBon

1 x Canopy:
ARC or CUP or CUP with Plug-in

1 x Kit:
KIT.WM5.02 or KIT.WM8.02





Z00.030.01/N00.030.01
Housing for plasterboard

M00.030.01
Housing for brickwork



Z00.040.01
Housing for plasterboard



Z00.055.01
Housing for plasterboard

M00.055.01
Housing for brickwork



Z00.060.01
Housing for plasterboard

Pop P00 Ø 3,0

Pop P00 Ø 3,0

Pop P01 Ø 4,0

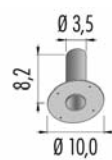

1Z00.030.01
Ø 4,0 cm

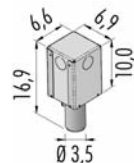

1M00.030.01

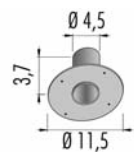

1Z00.040.01
Ø 5,1 cm

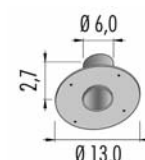

1Z00.055.01
Ø 6,5 cm

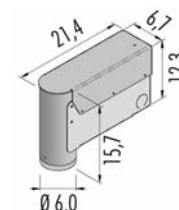

1M00.055.01

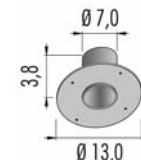

1Z00.060.01
Ø 7,6 cm

Pop P00 NaNo Ø 3,0

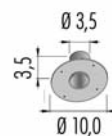

1N00.030.01
Ø 4,0 cm

POP P01 Ø 5,5
POP P01 NaNo Ø 5,5
POP P01 Bulb Ø 6,0
POP P01 Bulb Ø 9,5
POP P02 Ø 5,5

Pop P03 Ø 6,0
Pop P03 NaNo Ø 6,0

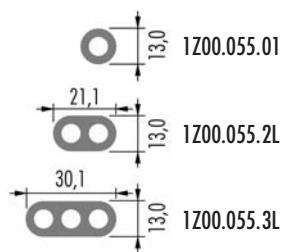



Pop P03 Ø 8,0

Z00.080.01
Housing for plasterboard

M00.080.01
Housing for brickwork

- Pop P03 Ø 8,0
- Pop P03 NaNo Ø 8,0
- Pop P04 Ø 8,0
- Pop P12 Ø 3,0

- Pop P03 Ø 8,0
- Pop P03 NaNo Ø 8,0
- Pop P12 Ø 3,0

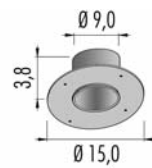

1Z00.080.01
Ø 9,5 cm

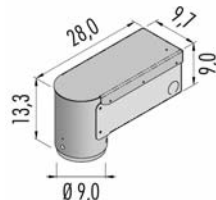

1M00.080.01

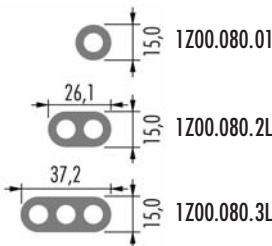

Pop PX3 Ø 10,0

Z00.100.01
Housing for plasterboard

- Pop PX3 Ø 10,0
- Pop PX3 NaNo Ø 10,0
- Pop PY3 Ø 10,0
- Pop PY3 NaNo Ø 10,0
- Pop PZ3 Ø 10,0

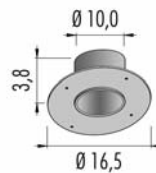

1Z00.100.01



Pop P12 Ø 7,0

Z00.120.01
Housing for plasterboard

M00.120.01
Housing for brickwork

- Pop P04 Ø 12,0
- Pop P12 Ø 7,0
- Pop P12 Ø 12,5
- Pop P122 Brooklin Arc
- Pop P202 Brooklin Arc

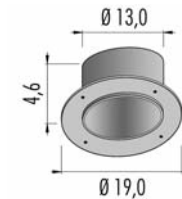

1Z00.120.01
Ø 14,0 cm

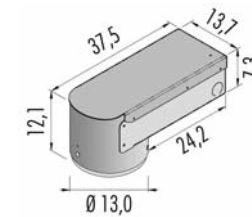

1M00.120.01

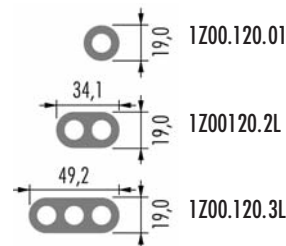

Pop P01 Dynamic Ø 12,5

Z00.125.01
Housing for plasterboard

M00.125.01
Housing for brickwork

- Pop P01 Static Ø 12,5
- Pop P01 Dynamic Ø 12,5
- Wally W01 Dynamic Ø 12,5

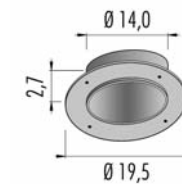

1Z00.125.01
Ø 14,0 cm

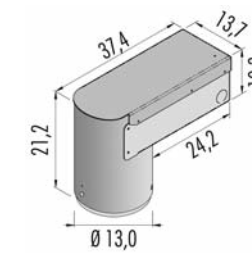

1M00.125.01

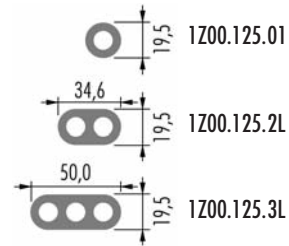



Pop P03 Ø 17,0

Z00.170.01
Housing for plasterboard

M00.170.01
Housing for brickwork

- Pop P03 Ø 17,0
- Pop P03 Static Ø 17,0
- Pop P03 Wall Wash Ø 17,0
- Pop P03 Look Ø 17,0

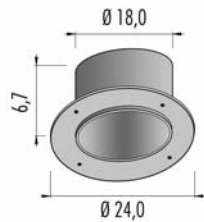

1Z00.170.01
Ø 19,0 cm

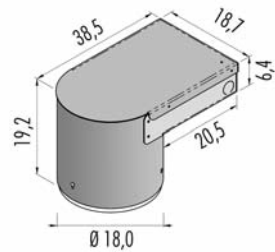

1M00.170.01

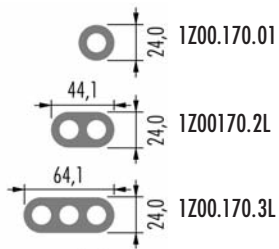

easy Pop X3 Ø 10,0

Easy POP
Housing for brickwork

- Easy Pop P00 Ø 3,0
- Easy Pop P00 NaNo Ø 3,0
- Easy Pop P01 Ø 4,0

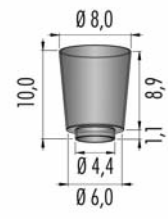

1E00.030.01

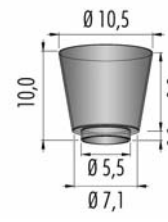

1E00.040.01

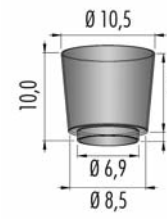

1E00.055.01

- Easy Pop P03 Ø 8,0
- Easy Pop P03 NaNo Ø 8,0
- Easy Pop P04 Ø 8,0
- Easy Pop PX3 Ø 10,0
- Easy Pop PX3 NaNo Ø 10,0
- Easy Pop PY3 Ø 10,0
- Easy Pop PY3 NaNo Ø 10,0
- Easy Pop PZ3 NaNo Ø 10,0

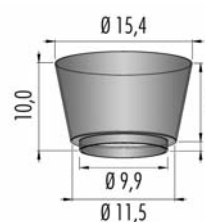

1E00.080.01

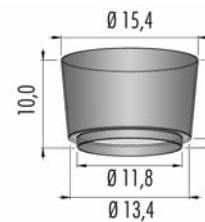

1E00.100.01

- Easy Pop P01 Ø 5,5
- Easy Pop P01 NaNo Ø 5,5
- Easy Pop P01 Bulb
- Easy Pop P02 Ø 5,5



W00.085.01
Housing for plasterboard

- Pop P04A Magic
- Pop P04B Magic

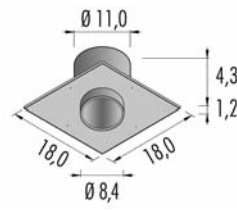

1W00.085.01



W00.125.01
Housing for plasterboard

- Pop P04C Magic
- Pop P12/L Ø 3,0

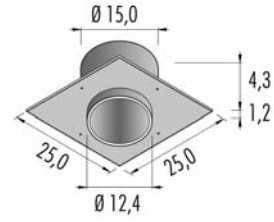

1W00.125.01



K00.170.01
Housing for plasterboard

Pop P03 Look

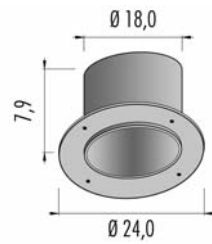

1K00.170.01
Ø 19,0 cm



M00.067.01
Housing for brickwork

Pop P05 Ø 6,7

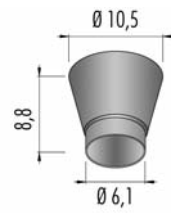

1M00.067.01

Pop P05 Ø 6,7 For brickwork

M00.082.01
Housing for brickwork

Pop P05 Ø 8,2

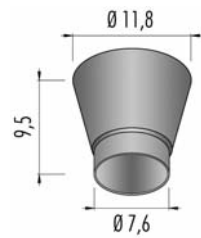

1M00.082.01



Z00.070.01
Housing for plasterboard

Pop P10

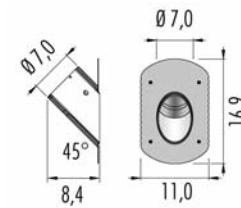

1Z00.070.01

M00.070.01
Housing for brickwork

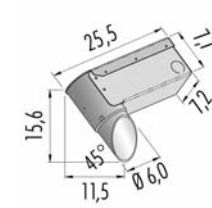

1M00.070.01



Z00.043.01
Housing for plasterboard

Pop P11

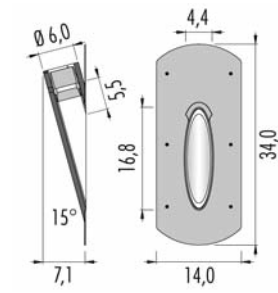

1Z00.043.0

Pop installation on plasterboard

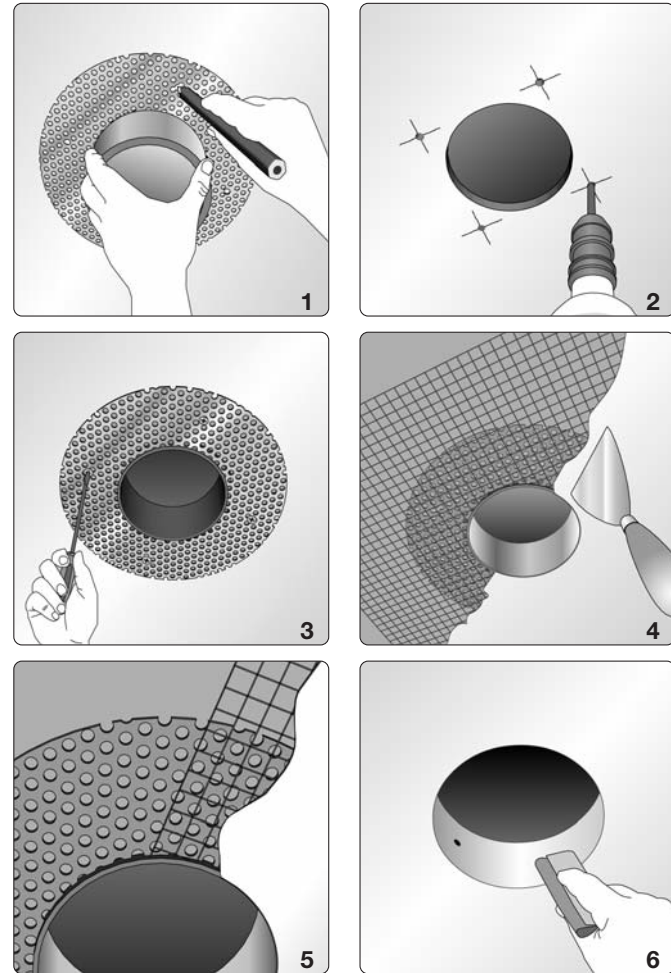

- 1) once pointed the position of the lamp mark the fixing holes for the housing
- 2) make the hole for the housing and the holes for the fixing rawlplugs
- 3) fix the screws of the housing to the ceiling plasterboard
- 4) apply the proper grasping net
- 5) plaster and trim the compensating 2 mm gap
- 6) keep clean the inside of the housing

Z00.030.01
 Z00.040.01
 Z00.055.XX
 Z00.060.01
 Z00.080.XX
 Z00.120.XX
 Z00.125.XX
 Z00.170.XX
 K00.170.01
 Z00.070.01
 Z00.043.01

Pop installation on brickwork

Form a recess in the ceiling for the brickwork housing.
 Insert the power cables in to the brickwork housing and complete the ceiling with plaster finish.
 Keep the inside brickwork housing clean. Install the item into the housing.

M00.030.01
 M00.055.01
 M00.080.01
 M00.120.01
 M00.125.01
 M00.170.01
 M00.070.01

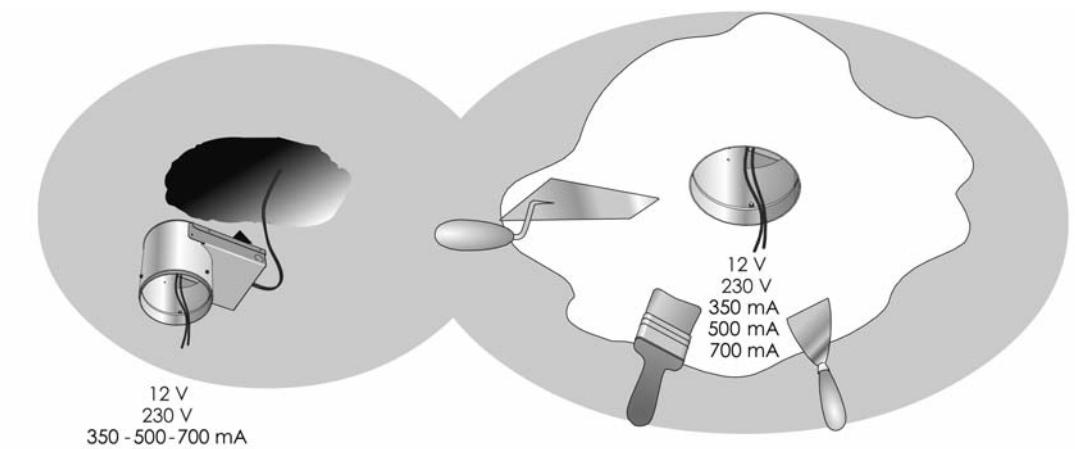

12 V
 230 V
 350 - 500 - 700 mA

12 V
 230 V
 350 mA
 500 mA
 700 mA

Pop 04 Magic 25/40/120 h.

Code: W00.085.01 (P04A - P04B)
Housing for plasterboard

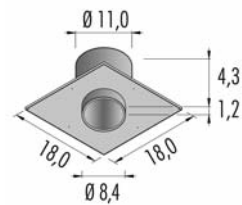

Code: W00.125.01 (P04C)
Housing for plasterboard
Gehäuse für Gipskarton

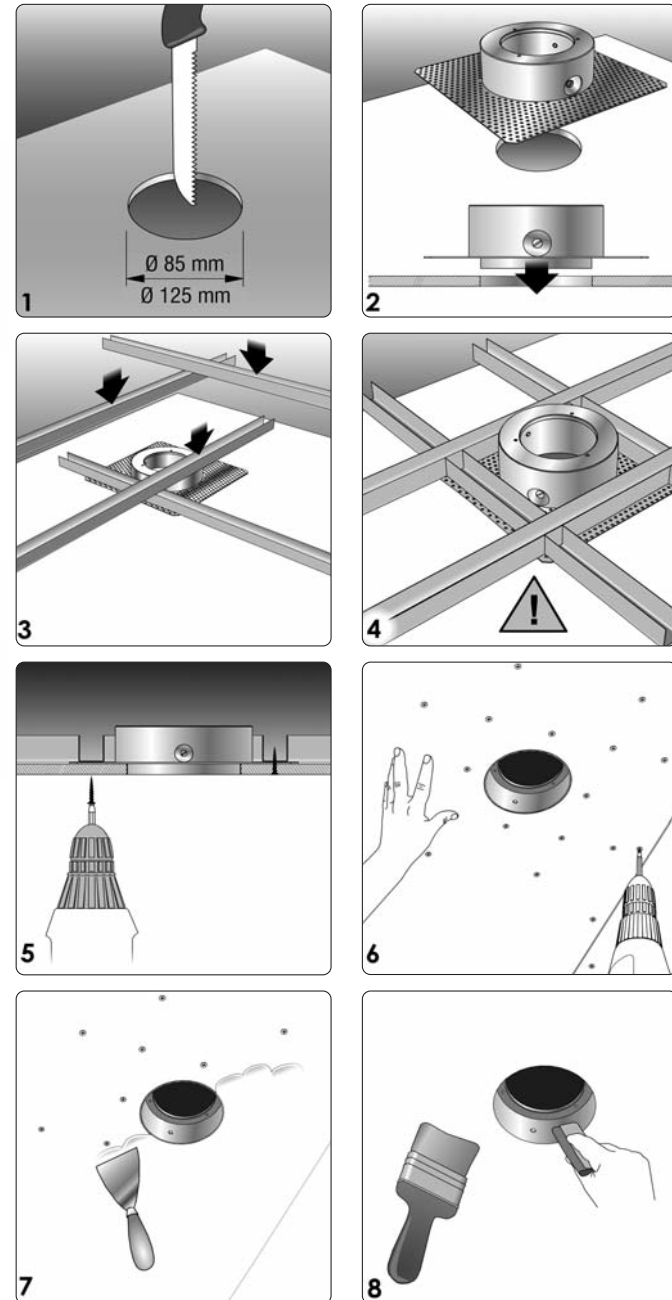
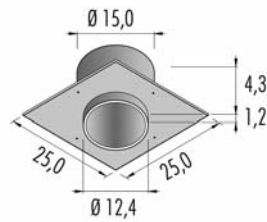

- 1) Once pointed the position of the lamp, make the hole for the housing.
- 2) Place the housing on the side of the plasterboard plate that will remain invisible after the work is done.
- 3 - 4) Put some metal profiles to fix and reinforce the area of the housing.
- 5) Fix with screws, the housing to the plasterboard and to the reinforcement profiles.
- 6 - 7) Complete the false ceiling, plaster and trim.
- 8) Keep clean the inside of the housing.

Pop 12 L 120 h.

Code: W00.125.01 (P12L)
Housing for plasterboard

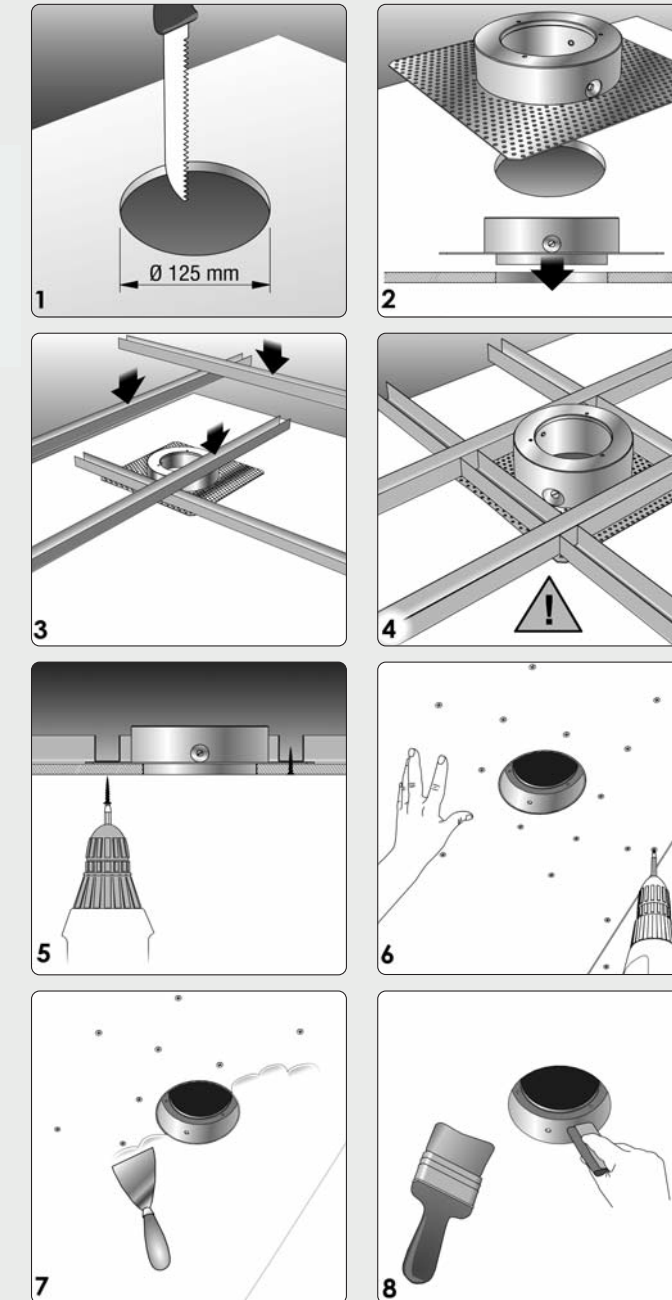
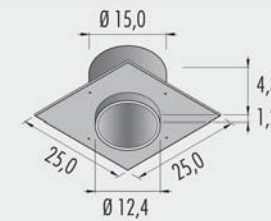

- 1) Once pointed the position of the lamp, make the hole for the housing.
- 2) Place the housing on the side of the plasterboard plate that will remain invisible after the work is done.
- 3 - 4) Put some metal profiles to fix and reinforce the area of the housing.
- 5) Fix with screws, the housing to the plasterboard and to the reinforcement profiles.
- 6 - 7) Complete the false ceiling, plaster and trim.
- 8) Keep clean the inside of the housing.

Pop 10 installation on plasterboard

Code: **Z00.070.01**
Housing for plasterboard

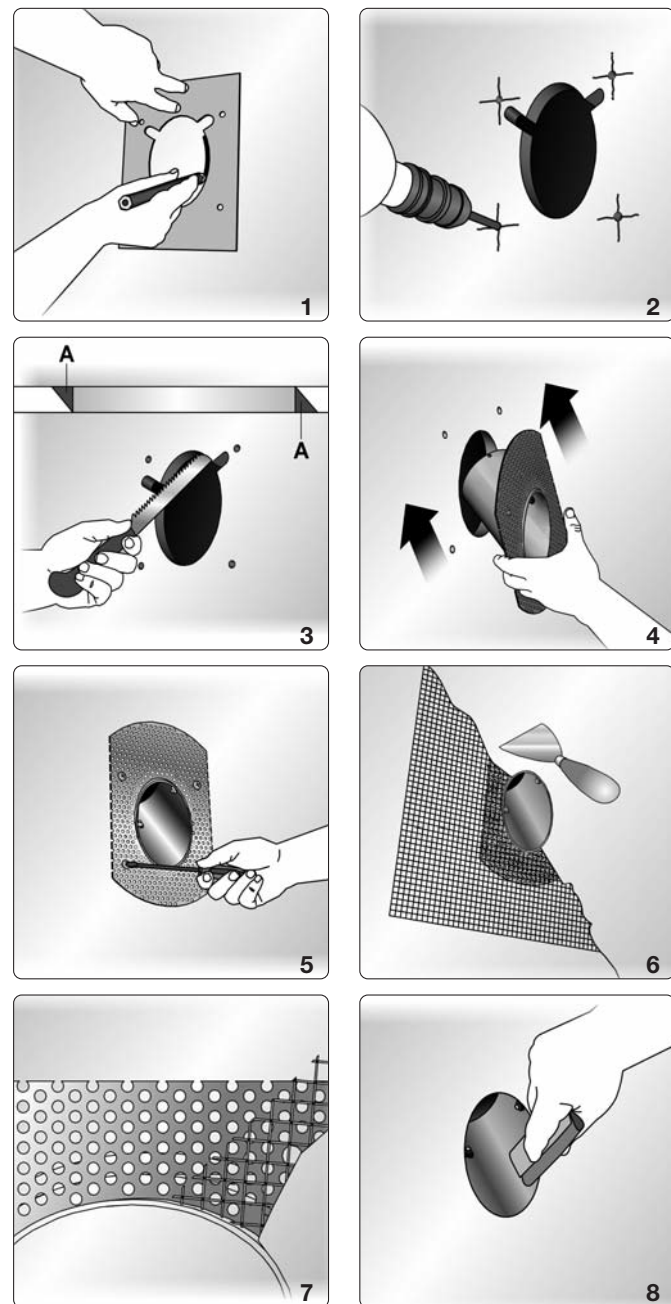
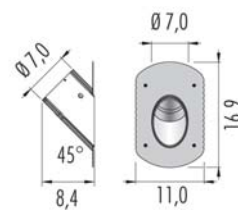

- 1) Once pointed the position of the lamp, mark with the given shape the entry hole and the fixing holes for the housing.
- 2) Make the hole for the housing and the holes for the fixing dowels.
- 3) Adjust the inside edge of the housing entry hole to allow the element installation at 45°.
- 4) Put the housing into the hole with a move at nearly 45° compared to the fixing surface.
- 5) Fix the housing to the ceiling or wall plasterboard with the screws.
- 6) Apply the proper grasping net.
- 7) Plaster and trim compensating the 1 mm gap.
- 8) Keep clean the inside of the housing.

Pop 10 installation on brickwork

Code: **M00.070.01**
Housing for brickwork

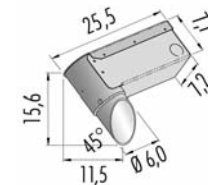

- 1) Form a recess in the ceiling for the brickwork housing.
- 2) Insert the power cables in to the brickwork housing and complete the ceiling with plaster finish.
- 3) Keep the inside brickwork housing clean.
- 4) Install the item into the housing.

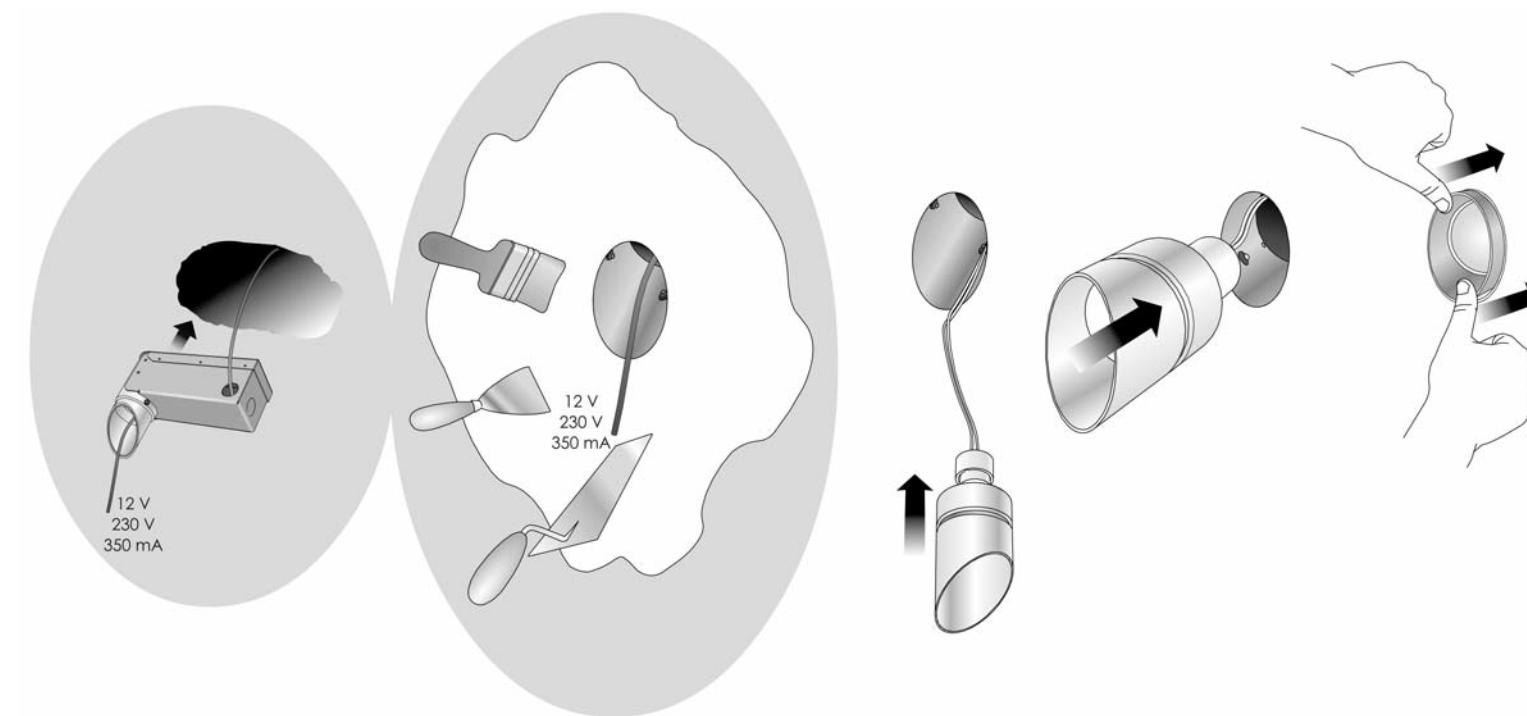

Pop 11 installation on plasterboard

Code:
Z00.043.01
Housing for plasterboard

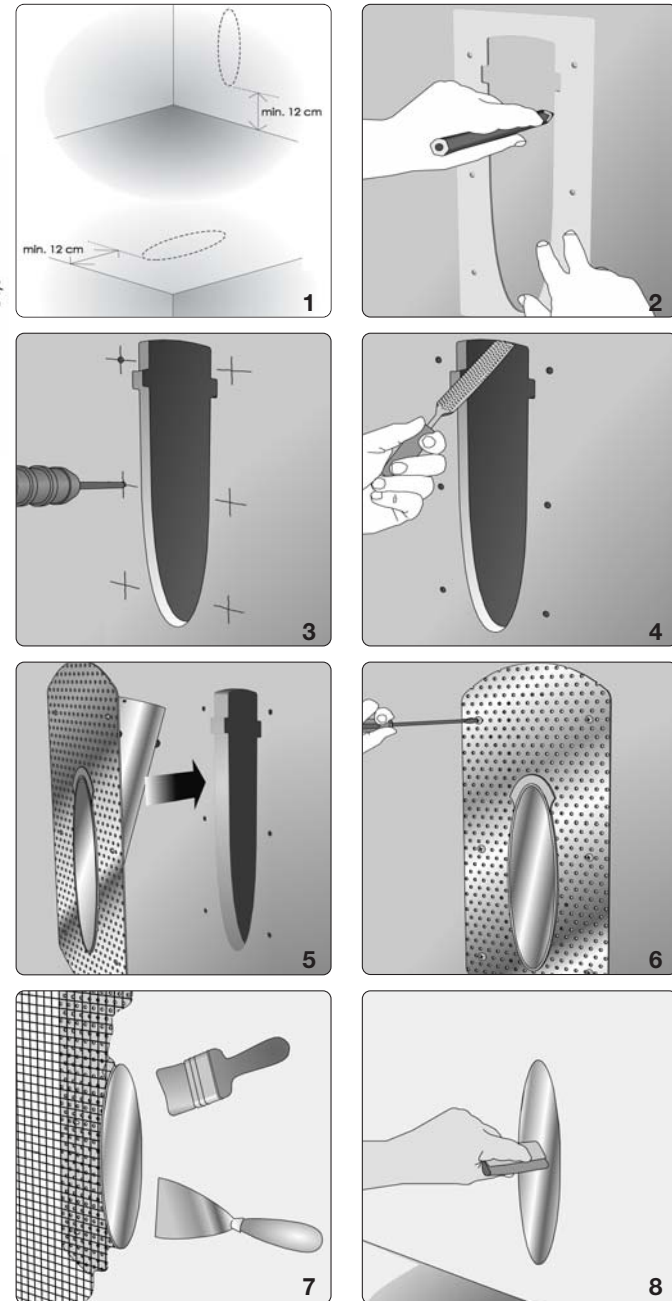
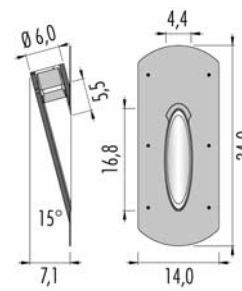

- 1) Once pointed the position of the lamp, mark with the given shape the entry hole and the fixing holes for the housing.
- 2) Make the hole for the housing and the holes for the fixing dowels.
- 3) Adjust the inside edge of the housing entry hole.
- 4) Put the housing into the hole.
- 5) Fix the housing to the ceiling or wall plasterboard with the screws.
- 6) Apply the proper grasping net.
- 7) Plaster and trim compensating the 1 mm gap.
- 8) Keep clean the inside of the housing.

Bic installation on plasterboard

Z07.070.01
Housing for plasterboard

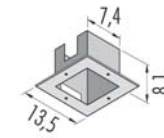

BIC B07

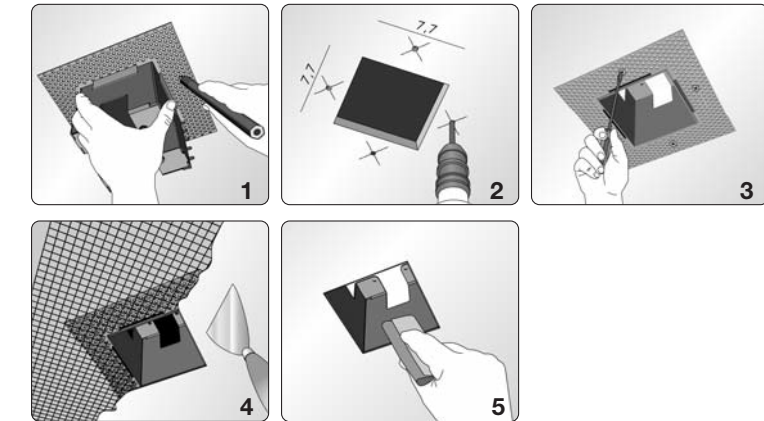
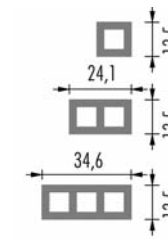

Z12.120.01
Housing for plasterboard

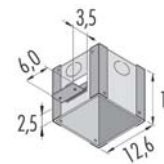

BIC B12

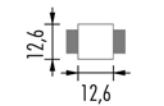

Z0B.016.01
Housing for plasterboard

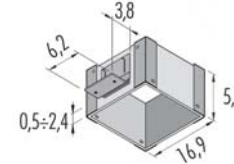

BIC B16

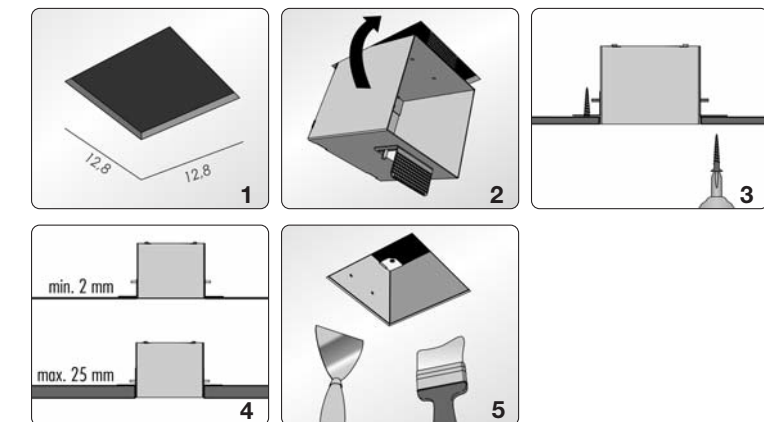
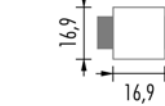

Z0B.025.01 - Z0B.050.01 - Z0B.060.01

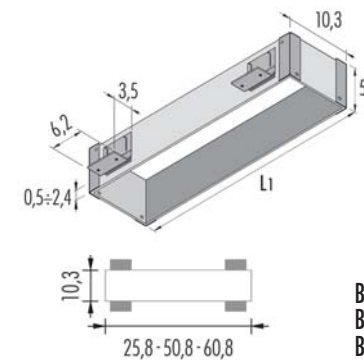

BIC B25 L1= 25,8
BIC B50 L1= 50,8
BIC B60 L1= 60,8

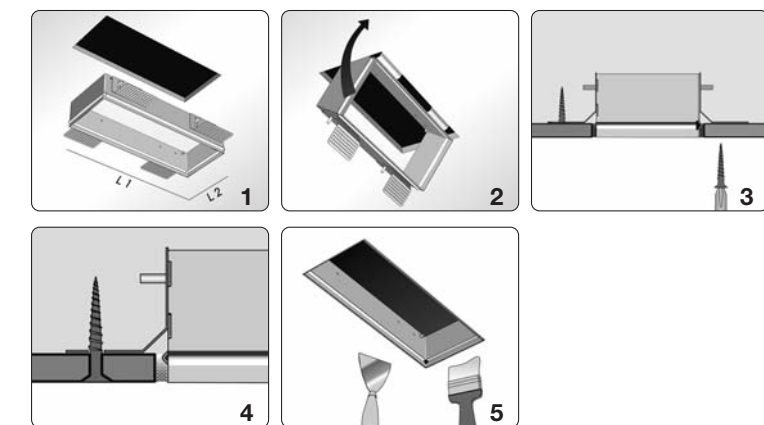

Easy Pop installation on plasterboard: Pop P00/P01/P02

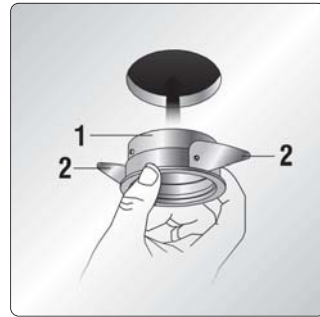
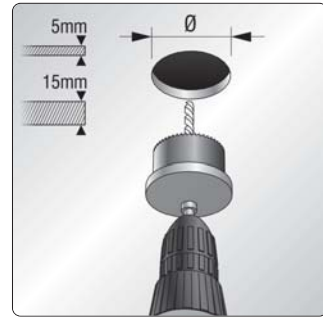

Drill the ceiling with a cutter corresponding to the diameter.

Bend the springs (2) of the housing (1) to put it into the hole with a counterclockwise rotation.

Make the connection of the spot light to the remote gear.

Inserting element (3) inside element (1), pay attention to fit the two little guide cylinders (5) of the housing (1) into the grooves (4) (Stage A).

Rotate element (3) as far as it goes (Stage B).

Finally pull down element (3) till the foreseen final position (Stage C).

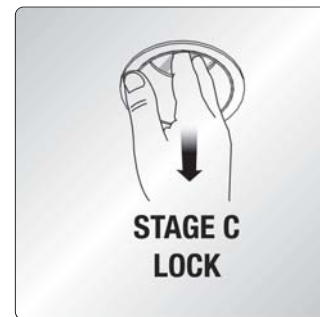
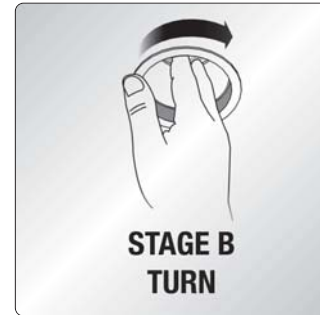
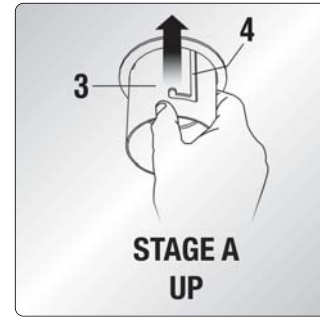
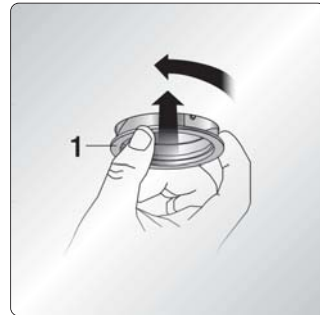
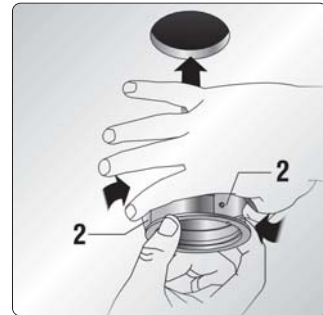

To replace the LED light bulb, unscrew the two screws (6). Gently remove the LED support (1). After having replaced the LED lightbulb (7) put again support (1) and screw again the two screws (6).

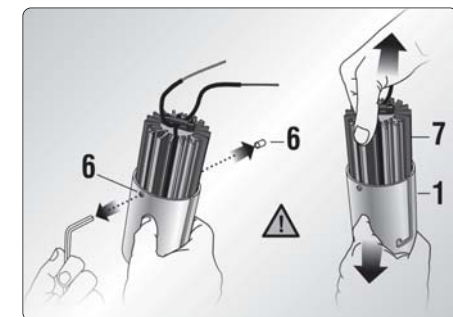

Easy Pop installation on plasterboard: Pop P03/PX3/PY3/PZ3

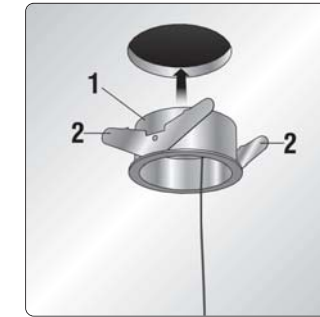
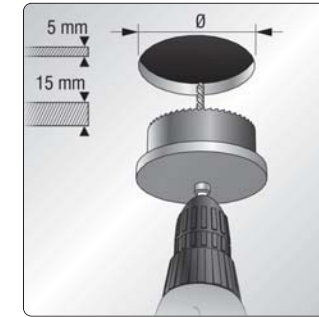

Drill the ceiling with a cutter corresponding to the diameter.

Bend contemporarily the springs (2) of the housing (1) to put it into the hole.

Unscrew the screw (4) of the lamp body.

Using the screw (4), fix the lamp body (3) to the safety anti-fall cable (5).

Make the connection of the spot light to the remote gear.

Put the body of the lamp (3) into element (1) with the CLICK UP.

Adjust element (6) as required.

To replace the LED light bulb, gently remove the body of the lamp (3) DOWN.

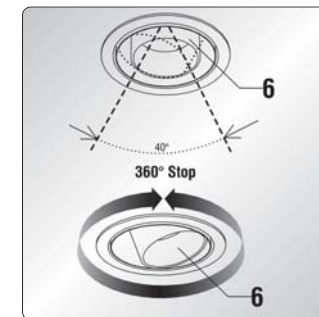
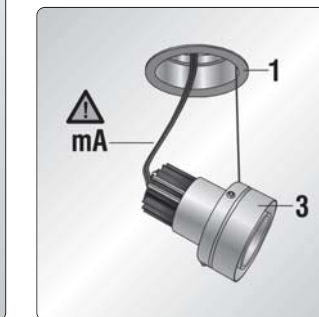
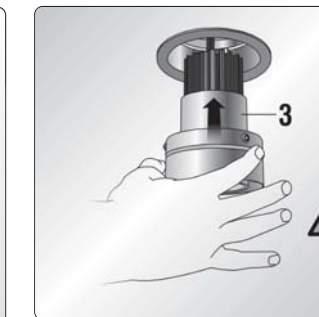
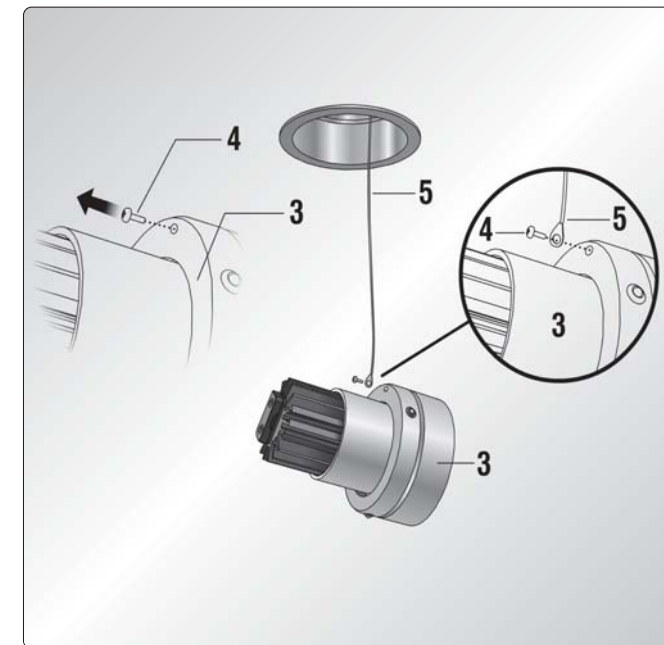
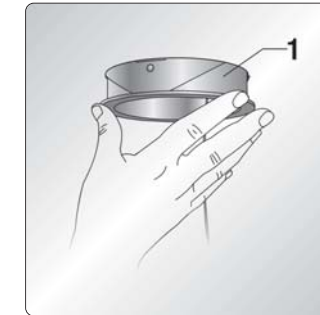
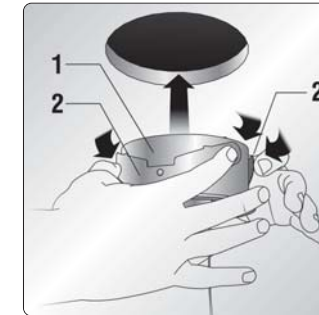

Vademecum

MC-E

MacAdams step:

é un parametro attraverso il quale si definisce il grado di decadimento del colore della luce di una sorgente led nel tempo. Lo step 3 rappresenta ad oggi il livello di decadimento più basso.

it is a parameter which defines the deterioration degree of the colour of the light coming from a led source during its life. Step 3 is nowadays the lower deterioration level.

es ist ein Parameter, der der Verschlechterungsgrad der Lichtfarbe eines Led Leuchtmittels während seines Lebens bestimmt. Step 3 ist heutzutage das niedrigste Verschlechterungsniveau.

Est un paramètre avec le quel on défini le degré de détérioration de la couleur de la lumière d'une source led dans le temps. Aujourd'hui le Step 3 est le niveau de détérioration le plus bas.

el es un parámetro que define el grado de deterioración del color de la luz de una fuente led en el tiempo. El step 3 representa hoy el nivel de deterioración más bajo.

CRI

Indice di resa cromatica di una sorgente luminosa, e misura di quanto naturali appaiano i colori degli oggetti da essa illuminati.

Colour Rendering Index of a light source and measure indicating how natural the colours of objects appear when enlightened from it.

Farbwiedergabeindex einer Lichtquelle und Maß, das, wie nach der Natur die Farben der Objekten sich herausstellen, wenn sie von dieser Lichtquelle beleuchtet sind, anzeigt.

Indice de rendu des couleurs d'une source lumineuse et mesure qui indique la pureté des couleurs des objets éclairés par cette source.

Indice de rendimiento lumínico de una fuente luminosa, y medida de lo natural del color de los objetos iluminados con dicha fuente.

lm

Il lumen è l'unità di misura del flusso luminoso di una sorgente luminosa. Lumen is the unit of the light flux of a light source.

Lumen ist ein Maß der Strahlengang einer Lichtquelle.

Le lumen est l'unité de mesure du flux d'éclairage d'une source lumineuse.

El lumen es la unidad de medida del flujo luminoso de una fuente luminosa.

lx

Il lux è l'unità di misura per l'illuminamento di un'area piana. Un lux è pari a un lumen fratto un metro quadrato.

Lux is the unit for the lighting of a flat area. One lux is equal to one lumen divided per one square meter.

Lux ist ein Maß für die Beleuchtung einer ebenen Oberfläche. Ein lux ist gleich ein lumen geteilt durch einen quadratischen Meter.

Le lux est l'unité de mesure pour l'illumination d'une zone plane. Un lux correspond à un lumen divisé par mètre carré.

El lux es la unidad de medida de iluminación de una superficie. Un lux es equivalente a un lumen por metro cuadrado.

⊕

Classe I: Le componenti elettriche accessibili sono collegate ad un conduttore di terra.

Class I: Only basic insulation, accessible conductors are earthed. Earthing compulsory.

Klasse I: Grundisolation leitenden; berührbare Metallteile sind mit Schutzerdung verbunden. Schtzerdung vorgeschriben.

Class I: Seulement isolation de base, les parties conductrices accessibles sont reliées à un conducteur terre.

Mise à la terre obligatoire.

Clase I: Sólo aislamiento fundamental; además, las partes conductoras accesibles están conectados a un conductor de tierra. Puesta a tierra indispensable.

□

Classe II: Messa a terra esclusa, sostituita da cavi elettrici con un isolamento rinforzato.

Class II: basic insulation plus second insulation or both are replaced by reinforced insulation. Earthing excluded

Klasse II: Entweder zu der Grundisolierung kommt noch eine zweite Isolierung hinzu oder ist eine verstrebtten Isolierung vorgesehen.

Class II: Soit à l'isolation, soit ces deux dernières sont remplacées par une isolation renforcée.

Mise à la terre: excluse.

Clase II: Al aislamiento fundamental se añade un segundo aislamiento, o bien los dos aislamientos se reemplazan por un aislamiento reforzado.

⚡

Classe III: Alimentazione a bassa tensione, inferiore a 50V-50Hz. Messa a terra non prevista.

Class III: Low tension inferior to 50V-50Hz. No ground cable.

Klasse III: Niedervolt < 50V-50 HZ, ohne Erdung

Class III: Alimentation de sécurité à basse tension.

Ne doit en aucun cas être utilisée pour des tensions supérieures à 50V-50Hz. mise à la terre.

Clase III: Alimentación de baja tensión, inferior a 50V-50Hz. Toma de tierra no prevista.

▽

Apparecchio con caratteristiche per il montaggio diretto su superfici normalmente infiammabili (EN 60 598/VDE 0711).

Device which can be mounted on flammable surfaces (EN 60 598/VDE 0711).

Aparato con características para el montaje directo sobre superficies normalmente inflamables (EN 60 598/VDE 0711).

CE

Prodotto conforme alle direttive europee.

Products complying with the Eur. Comm. rules.

Produkt gemäss den EU-Normen.

Producido conforme a las directivas europeas.

IP identification

IP0X

nessuna protezione
no protection
kein Schutz
Driver fourni
sin protección

IP1X

protezione contro corpi estranei ≥ 50mm
protection against solid objects ≥ 50mm
Schutz gegen Fremdkörpern ≥ 50mm
protection contre des corps étrangers ≥ 50mm
protegido contra objetos extraños ≥ 50mm

IP2X

protezione contro corpi estranei ≥ 12mm
protection against solid objects ≥ 12mm
Schutz gegen Fremdkörpern ≥ 12 mm
protection contre des corps étrangers ≥ 12mm
protegido contra objetos extraños ≥ 12mm

IP3X

protezione contro corpi estranei ≥ 2,5mm
protection against solid objects ≥ 2,5mm
Schutz gegen Fremdkörpern ≥ 2,5mm
protection contre des corps étrangers ≥ 2,5mm
protegido contra objetos extraños ≥ 2,5mm

IP4X

protezione contro corpi estranei ≥ 1mm
protection against solid objects ≥ 1mm
Schutz gegen Fremdkörpern ≥ 1mm
protection contre des corps étrangers ≥ 1mm
protegido contra objetos extraños ≥ 1mm

IP5X

protezione da polvere
dust-protected
Staubgeschützt
protection contre la poussière
aparato protegido contra el polvo

IP6X

stagno alla polvere
dust-proof
Staubdicht
hermétique à la poussière
aparato totalmente protegido contra el polvo

IPX0

nessuna protezione
no protection
kein Schutz
non protégé
sin protección

IPX1

protezione contro caduta acqua verticale
protected against water drops falling vertically
Schutz gegen Wassertropfen, die senkrecht herabfallen
protégé contre les gouttes d'eau tombant verticalement
protegido contra la caída de gotas de agua

IPX2

protezione contro caduta di gocce oblique a 15°
protected against water drops max inclination 15°
Schutz gegen Wassertropfen, die senkrecht herabfallen Neigung 15°
protégé contre les gouttes d'eau à inclinaison maximale de max 15°
protegido contra la caída de gotas de agua con inclinación max 15°

IPX3

protezione contro caduta di gocce oblique a 60°
protected against water drops max inclination 60°
Schutz gegen Wassertropfen, die senkrecht herabfallen Neigung 60°
protégé contre les gouttes d'eau à inclinaison de max 60°
protegido contra la caída de gotas de agua con inclinación max 60°

IPX4

protezione contro spruzzi d'acqua
protected against sprinkling water
Spritzwassergeschützt
protégé contre les éclaboussures
aparato protegido contralas salpicaduras

IPX5

protezione contro getti d'acqua
protected against water jets
Wasserstrahlgeschützt
protégé contre les gouttes d'eau
aparato totalmente protegido contra los chorros de agua

IPX6

protezione contro inondazioni
Potected against flooding
Überschwemmunggeschützt
rotected against flooding
aparato totalmente protegido contra

IPX7

protezione per immersione temporanea
protected against brief immersions
gegen kurzen Tauchen geschützt
hermétique à la immersion
aparato totalmente protegido contra la sumersión

IPX8

protezione per immersione costante
protected against long immersion
Tauchengeschützt
protégé pour des immersions prolongées
aparato totalmente protegido contra la larga imersión

General Sales Terms

1- Invalidity of the General Sales Terms and of the Price Lists previously in force

1.1 All the sales and payment terms previously in force are expressly cancelled and replaced by the following general sales terms, as the present price list cancels and replaces each previous edition; both are **valid since 01/09/2019** and they could be updated or modified at any time, giving notice if necessary through the pages of the web site www.otylight.com

2- Application and acceptance of the General Sales Terms:

2.1 The business relationships between Oty srl and its customers are exclusively regulated by the following general sales terms, with express renunciation and exclusion of any other agreement.

2.2 Sending an order to Oty srl, the customer declares to have gone through all the information given to him and to accept entirely, without any reservation, all the following general sales terms, which must be considered as an integral and substantial part of the sales contract.

2.3 The contract will be valid only once the customer's order is approved in writing by Oty srl. The parties could agree on possible changes, integrations or derogations to the above mentioned general sales terms, which should appear in writing in the documents including the order of the purchaser and the relating express acceptance of the seller in the order confirmation. The exclusions or the modifications introduced by the customer, if not expressly confirmed in written by Oty srl, do not bind Oty and do not become integral part of the contract, even if they have not been expressly refused and/or challenged. In any case the missing answer does not mean acceptance.

2.4 The customer is not entitled to damages and it is excluded any contractual or extra-contractual responsibility for direct or indirect damages to persons and/or things, caused by the missing acceptance, even if partial, of an order.

3- Presentation of the products:

3.1 Oty srl improves constantly its products and therefore reserves the right to introduce the necessary changes or updating at its exclusive discretion at any time. For this reason the products' technical and dimensional information (instructions for use, drawings, illustrations, technical data, weight, measure and performances descriptions) written in brochures, catalogues, newsletters, advertisements and in price lists are not binding if not expressly specified in the order confirmation, and could be subject to modifications or updating without any advance notice.

4- Offers and Prices:

4.1 All prices written in the price list are expressed in EURO, not including VAT.

4.2 These prices could be modified at any time at Oty srl exclusive discretion and with no obligation of any advance notice or communication.

4.3 Prices do not include light bulbs, if not differently and previously specified in written between the parties.

4.4 The offers of Oty srl and the customers' orders must be always considered "except for availability and prices changes".

5- Orders:

5.1 Each Order sent to Oty srl must be considered as a definitive and binding proposal for the purchaser, and this could be cancelled or modified only through a written agreement between the parties.

Anyway, the orders for customized products or for products different from standard Oty light's product, could not be cancelled neither totally nor partially once they have been sent to Oty srl.

5.2 After receiving the order Oty srl is not obliged to communicate to the customer that the net value of the above mentioned order, since it is lower than the free port limit, implies the non-application of the under mentioned delivery "free port" clause.

5.3 In case of integration orders or anyway of orders linked to the previous ones, Oty do not guarantee the delivery of the same tone or design of the material previously delivered.

6- Delivery

6.1 The delivery terms indicated on the orders' confirmations or verbally agreed between the parties, have only an indicative value. Their non-observance, as also the possible delivery of partial or reduced supplies, will not cause either the cancellation of the relating order or the application of any fine or the acknowledgment of any kind of compensation.

7- Packaging:

7.1 The products are provided packed in boxes of recyclable carton, whose cost is included in the price.

8- Pick up of the goods:

8.1 The ordered and supplied goods must be regularly picked up by the customer. If Oty srl will not be responsible for the non-delivery or if the customer refuses the delivery of the goods, the customer himself will have to organize on his own, at his own expenses and on Oty written exhortation the pick up of the previously mentioned goods, which is the object of the contract, within the deadline communicated by Oty srl and, in addition, the customer will have to pay the price of the goods. Once this expiry date is passed uselessly, Oty srl is free from any responsibility and is authorized to issue an additional regular invoice for interests on arrears (ex D.Lgs 231/2002) accrued on capital and for goods storage costs and any further damage.

8.2 At the moment of the goods delivery by the forwarder, the customer has to make all the necessary controls to check the possible damages, missing pieces, defects or other apparent imperfections of the delivered goods in comparison to the order. Precisely he must control that:

8.2.1 The number of the delivered items corresponds to the number indicated in the delivery note.

8.2.2 The packaging is integral, not damaged, not wet or anyway altered, also the closing materials. Possible damages to the packaging and/or the goods, or the non-correspondence of the number of items or of the indications, must be immediately notified, writing "reservation of control" (and specifying the cause of this reservation) on the delivery note of the forwarder and also confirmed, writing the raised reservations in a recorded delivery letter with receipt of return to Oty srl. Once the delivery note of the forwarder has been signed, the customer could not complain anymore about the external peculiarities of the delivered goods.

9- Installation:

9.1 The installation and the connection/assembly of the goods, object of the supply, are at the customer's expenses and management.

All the products must be connected and installed according to the **C€** laws, or anyway to those in force, and according to the information contained in the catalogue and in the instruction sheets by skilled and expert personnel. Oty srl declines every responsibility for products sold and/or installed in countries in which there are laws that do not allow their use.

10- Returned goods:

10.1 Returned goods will be accepted only after written authorization by Oty srl and only if the product will be returned with all its original parts (including the possible documentation and accessories: instruction manuals, cables, etc. . .), in the original packaging, and within 7 days since the authorization. If just one of these requirements will be missing, Oty srl will return the goods to the sender ex factory. In any case, returned goods are considered free of port to Oty srl seat.

10.2 Except for any different instruction, the material will be credited only if it could be resold by Oty srl, net of costs for the control and restoring of it.

10.3 Anyway all the special productions, customized or produced according to the customer's specifications, or anyway different from standard Oty light product, as also the feeders/ballasts and housings for recessed items, could not be returned or refused.

11- Complaints:

11.1 Possible problems concerning the integrity, the correspondence or the completeness of the received goods, or any claim concerning manufacturing and/or quality defects of the goods must be notified in written, otherwise invalid, to Oty within 8 (eight) days since the date of the receipt of the goods (in case of apparent defects and/or imperfections) or since the discovery (in case of non-visible defects and/or defects).

Once this term is expired, no complain will be accepted.

11.2 For the approval of the complaint, the customer will have to demonstrate the correct maintenance and, if necessary, the correct installation of the product.

11.3 Possible claims or complaints, notified either bringing an action or raising an objection, will not allow the suspension of the goods' payments.

11.4 If the complaints will result groundless, Oty srl will debit the expenses paid for possible controls on the spot and also the costs and charges for possible surveys even if made by a third part.

12- Guarantee:

12.1 Oty product is made and controlled according to the **C€** laws, which guarantee the security and the technical quality of the materials.

12.2 Each Oty product has the guarantee foreseen by the laws in force since the delivery date of the goods, and by the way, the guarantee is limited to the items considered faulty and anyway to a maximum amount equal to the one of the bought goods. In any case Oty srl will not be obliged to compensate the customer for direct or indirect damages or for any other financial damage suffered by buyer or by a third part.

12.3 To benefit from assistance under guarantee, the customer must show the original invoice (or delivery note) and/or receipt for fiscal purposes.

12.4 The guarantee is applied to Oty product, if and only if, it is used correctly, according to its main use and to what is foreseen in the technical instructions attached.

12.5 It is excluded from the guarantee each defect of the product caused by a wrong installation, storage, maintenance, connection or assembling (non-observance of the **C€** laws in force and of the information written in the catalogue and in the possible assembling and instructions sheets), by a faulty servicing, by a wrong use or by a use not according to the technical or employment specifications (non-observance of the servicing and maintenance instructions and of the use conditions), by modifications or repairs, made by the customer or by a third part, by deteriorations or damages caused by external objects or events (such as incidents, blows, fires, acts of vandalism, water loss from pipes, natural or artificial lights (in case of discoloration), bad weather.

12.6 Products which have been tampered with or anyway damaged because of overloads, high or low voltage, unexpected chemical electrochemical/electrical alterations or because of a third party in general have no guarantee.

12.7 During the guarantee period, Oty srl commits itself, at its sole discretion, to substitute or repair the products or the products' pieces which Oty recognizes as faulty, or to reduce or pay back the corresponding price. Possible invoices for repairs made by a third part will not be in any case refunded by Oty srl.

12.8 If required, the customer will have to prove the defect with pictures which must be sent to Oty's e-mail address info@otylight.com.

13- Payment terms:

13.1 Except for any different instruction agreed in written between the parties, the supplies must be paid cash on delivery.

13.2 The payment must be made exclusively in Euro.

13.3 The customer does not have the right to counterbalance his debts towards Oty with his own possible credits or opposite demands. The customer could not raise any kind of objection to avoid or delay the payment of the required price.

13.4 In case of delayed payments, the customer must pay to Oty srl the interests on arrears (ex D.Lgs 231/2002), since the fixed expiry payment term. Possible discounts or allowances will decay.

13.5 In addition to what specified in the previous point, if the customer will not pay, even a part of the price, within the fixed expiry term, he will lose the benefit of the postponed payment ("benefit of the term"), also for the existing supplies; Oty srl could appeal to the application of articles no.1460 and 1461 of the Italian Civil Code and therefore suspend the ongoing supplies.

14- Withdrawal of the contract

14.1 Oty srl has the power to withdraw from the contract, with no charges, if it will know about the existence of protests as also the beginning of judicial (commanding decree) or extrajudicial processes against the client.

15- Renounce to recourse

15.1 Oty srl does not recognize to the customer the right of recourse (ex art. 131 D. Lgs: 06/09/2005, n. 206 and following modifications).

16- Applicable law and competent court:

16.1 The sales contract is regulated by the Italian law and it is excluded the application of any other international law or convention.

16.2 Considering the possible application of mandatory regulations, for any dispute related to the interpretation, application, execution of the sales contract and/or to the present "general sales terms" or anyhow related to them, the exclusive competent court will be Treviso.

Specific approval:

The customer/purchaser sending an order to Oty srl, admits and clearly confirms to have gone through and, according to the art. 1341 and 1342 C.C., and after reading, to accept and approve integrally and without reserve the above mentioned General Sales Terms, written also in the web site (www.otylight.com), which must be considered as an integral and substantial part of the sales contract and, in particular, the following articles:

1) Invalidity of the General Sales Terms and of the Price lists previously in force;

2) Application and acceptance of the General Sales Terms;

4) Offers and Prices;

5) Orders;

6) Delivery;

8) Pick up of the goods;

9) Installation of the product;

10) Returned goods;

11) Complaints;

12) Guarantee;

13) Payment terms;

14) Withdrawal of the contract;

15) Renounce to recourse;

16) Applicable law and competent court.



CREDITS

Graphic Concept	Claudio Malvestio
Stylist	Patrizia Toffolo
Images.....	Studio Fuoco - Franco Dell'Anna
Color separation	Artilab
Printing	Grafiche Gemma
Copyright	OTY s.r.l.
Printed in Italy	July - 2019

OTY RESERVES THE RIGHT TO INTRODUCE ANY CHANGES TO ITS OWN MODELS, WITHOUT NOTICE IN ADVANCE. ALL MODELS HAVE BEEN DULY REGISTERED.

OTY SI RISERVA IL DIRITTO DI APPORTARE AL PROPRI MODELLI, SENZ'ALCUN PREAVVISO, QUALSIASI MODIFICA RITENESSE OPPORTUNA. TUTTI I MODELLI SONO DEPOSITATI.

OTY BEHALT SICH DAS RECHT VOR ÄNDERUNGEN VORZUNEHMEN, OHNE SOFORTIGE BENCHRICHTIGUNG. ALLE MODELLE SIND EINGETRAGEN.

OTY SE RÉSERVE LE DROIT D'APPORTER UNE QUELCONQUE MODIFICATION À LES MODÈLES SANS PRÉAVIS. TOUS NOUS MODÈLES SONT DÉPOSÉS.

OTY SE RESERVA EL DERECHO DE REALIZAR CUALQUIER MODIFICACIÓN SOBRE SUS MODELOS SIN PREVIO AVISO. TODOS LOS MODELOS HAN SIDO DEPOSITADOS.

Oty s.r.l.
via Spangaro 8/a
30030 Peseggia di Scorzé
(Venezia) Italy

www.otylight.com
e-mail: info@otylight.com
t. +39 (0)41 5830499
f. +39 (0)41 5830520